

# ***KiboCUBE Academy***

***Live Session #2-1***

## **Introduction to CubeSat Attitude Control System**

Tohoku University

Department of Aerospace Engineering

Associate Professor Dr. –Ing. Toshinori Kuwahara

This lecture is NOT specifically about KiboCUBE and covers GENERAL engineering topics of space development and utilization for CubeSats.

The specific information and requirements for applying to KiboCUBE can be found at:

<https://www.unoosa.org/oosa/en/ourwork/psa/hsti/kibocube.html>



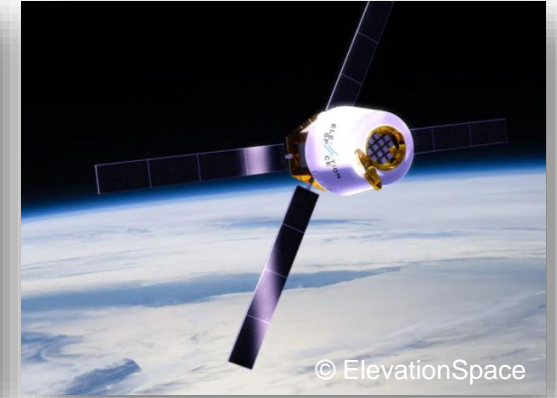
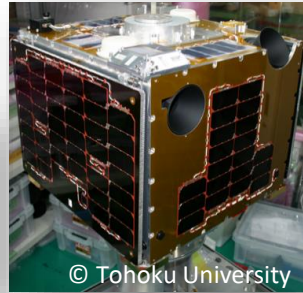
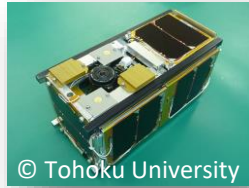

## Toshinori Kuwahara, Dr. -Ing.

### Position:

2015 - Associate Professor, Department of Aerospace Engineering, Tohoku University

2017 - Technical Advisor, Nakashimada Engineering Works, Ltd.

2017 - Technical Advisor, ALE Co., Ltd.

2020 - Chairperson, University Space Engineering Consortium Japan (UNISEC)

2021 - Co-founder/CTO, ElevationSpace Inc.

### Research Topics:

Space Development, Utilization, and Exploration by Small Spacecraft Technologies

# Contents

1. Introduction to Attitude Control System
2. CubeSat Attitude Control Mode
3. Hardware Components of Attitude Control System
4. Attitude Determination and Control Process
5. Functional Verification of Attitude Control System
6. Conclusion





# 1. Introduction to Attitude Control System

# 1. Introduction to Attitude Control System

## 1.1. Requirements of Satellite Attitude Control System

- Attitude Control System (ACS) is one of the satellite subsystems, which is responsible for attitude determination and control of the satellite body. ACS is sometimes denoted as Attitude Determination and Control System (ADCS).
- In general, attitude control of a satellite is required not only to achieve mission objectives, but also to survive in the space environment, mainly in terms of power generation and thermal control.
- Payload instruments of small satellites are usually mechanically fixed to the satellite body, and hence, the satellite attitude needs to be controlled in order to point those instruments to the desired directions.
- Attitude control types and accuracy depend on mission objectives.
- Typical attitude control requirements of satellites are:
  - Detumbling control – Detumble rotational rate
  - Pointing control – Point towards a certain direction for observation and/or communication
  - Spinning control – Spin-up around a specific direction

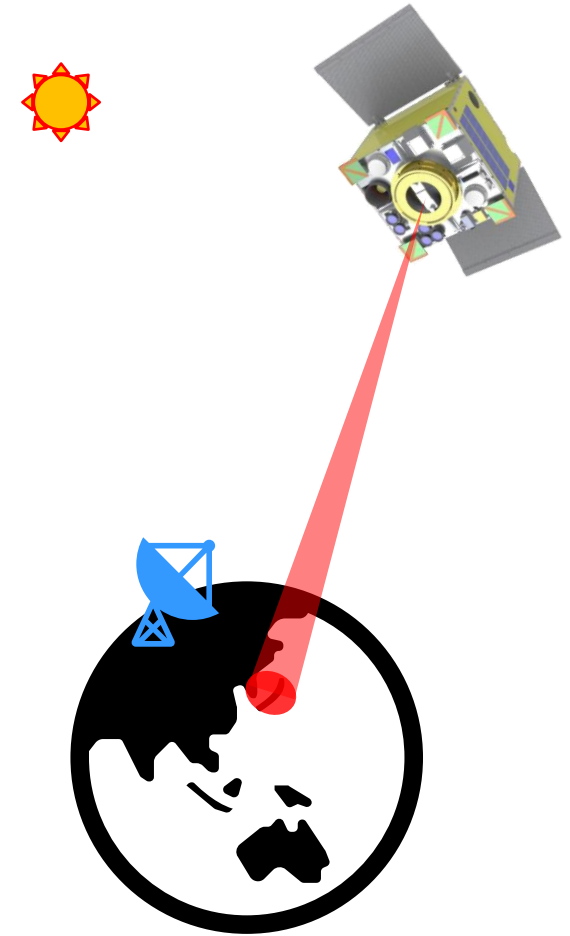

© Tohoku University

# 1. Introduction to Attitude Control System

## 1.1. CubeSat Dynamics and Control

Dynamic motion control of a CubeSat can be treated as the combination of translational motion control and rotational motion control. Dynamics problems of translational motion and rotational motion can be treated separately.

- **Translational Motion = Orbital Motion:**

- Satellite is regarded as a point of mass (motion of the center of mass of the satellite)
- Orbital position needs to be determined by means of ground observation or on-board instruments
- Satellite orbital motion can be propagated based on orbital mechanics
- Perturbation effects need to be estimated for precise orbit propagation
- Orbital parameters such as altitude, inclination, etc. need to be controlled through orbital maneuvers by means of thrusters, if required.

- **Rotational Motion = Attitude Motion:**

- Satellite attitude around its center of mass is handled separately from the orbital motion
- Satellite attitude needs to be determined by on-board sensor instruments
- Satellite attitude needs to be controlled by on-board actuator instruments by generating attitude control torques.
- Satellite attitude is controlled relative to the reference target attitude and/or reference target rotational rate.

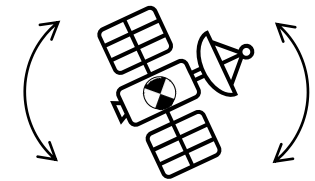
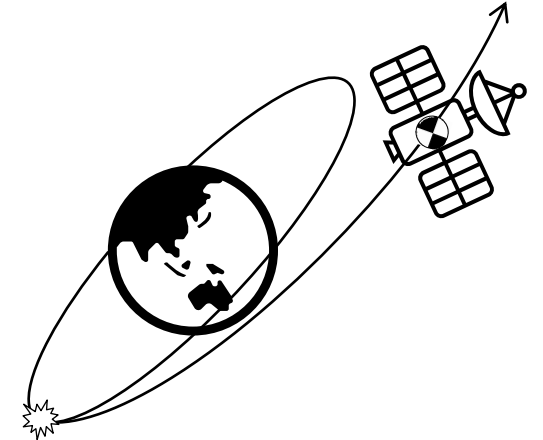

# 1. Introduction to Attitude Control System

## 1.3. CubeSat Dynamics and Control Process

The control process of spacecraft motion can be described in the following three steps:

### 1. **Navigation**

- Determine current **satellite position and velocity** (orbital motion), and **satellite attitude and rotational rate** (attitude motion).

### 2. **Guidance**

- Calculate desired **target position and velocity** (orbital motion), and **target attitude and rotational rate** (attitude motion), in order to achieve the objectives.

### 3. **Control**

- Make changes in **satellite position and velocity** (orbital motion), and **satellite attitude and rotational rate** (attitude motion), or keep them to certain fixed values, by means of actuators.

These processes are called GNC (Guidance, Navigation, and Control) and are conducted repeatedly and continuously. Attitude control accuracy is influenced by the accuracies in each of these steps.

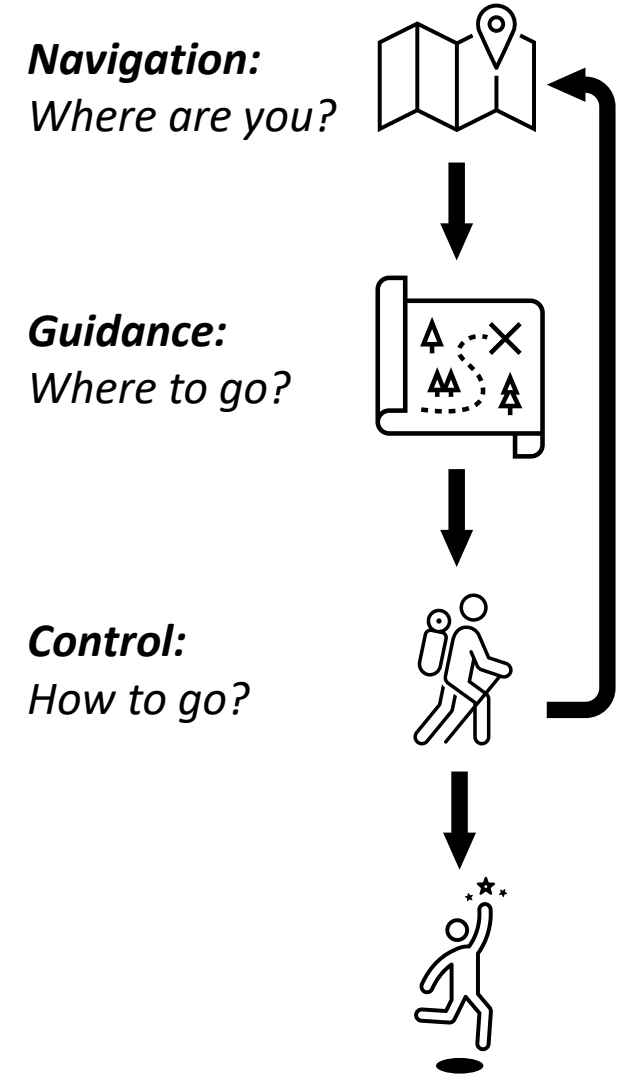



# 1. Introduction to Attitude Control System

## 1.4. Relationship between Orbital Motion and Attitude Motion

1. Influence of Orbital Motion to Attitude Motion → Attitude analysis requires orbital information.

2. Influence of Attitude Motion to Orbital Motion → Orbital analysis requires attitude information.

Change in target direction due to orbital motion

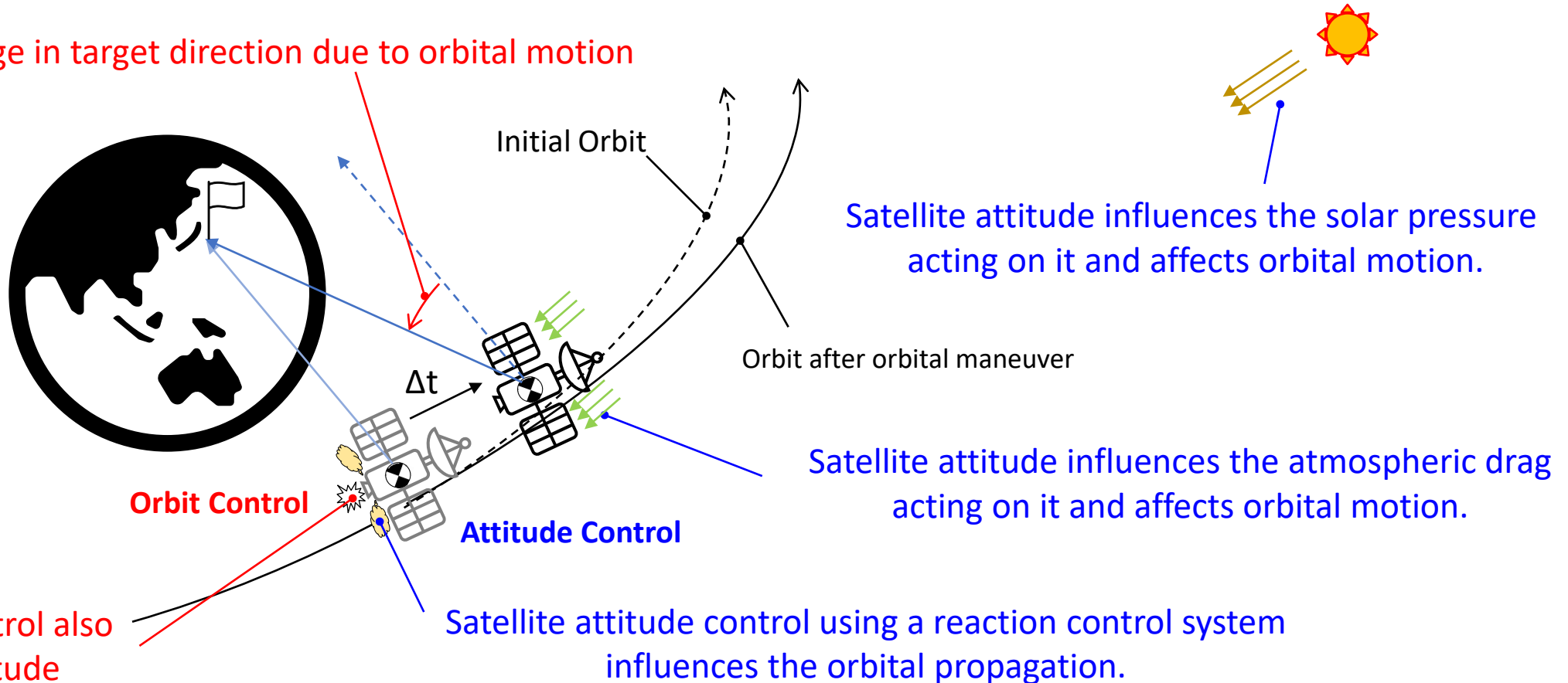



# 1. Introduction to Attitude Control System

## 1.5. Attitude Control System and Orbit Control System

A satellite system consists of several subsystems. Typical categorization is as follows:

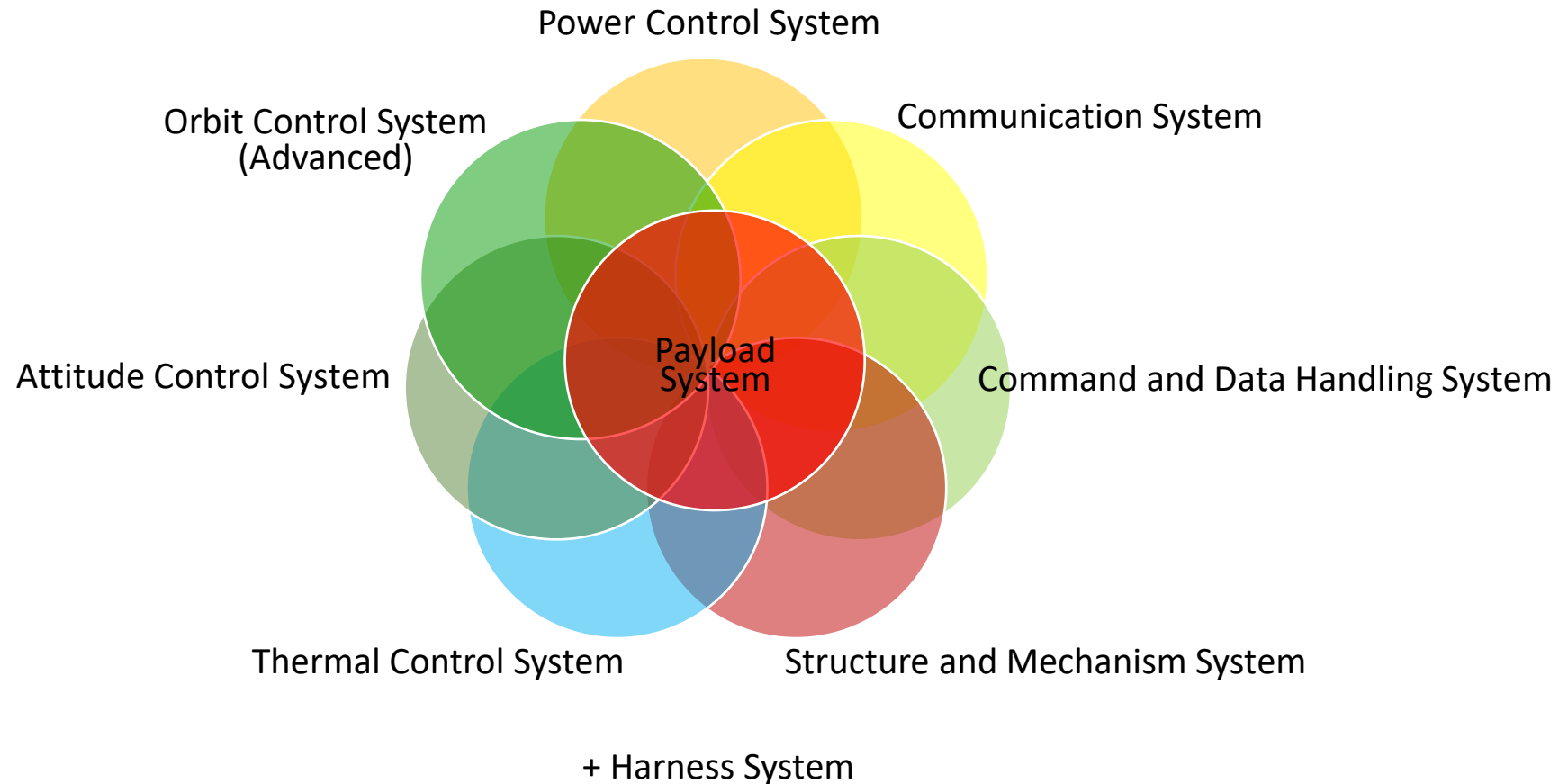

# 1. Introduction to Attitude Control System

## 1.6. Components of Attitude Control System

- Attitude control system (ACS) requires attitude determination sensors, attitude control actuators, and on-board computers. A satellite can have a dedicated computer for the ACS or ACS functionalities can be spread into several on-board computers.

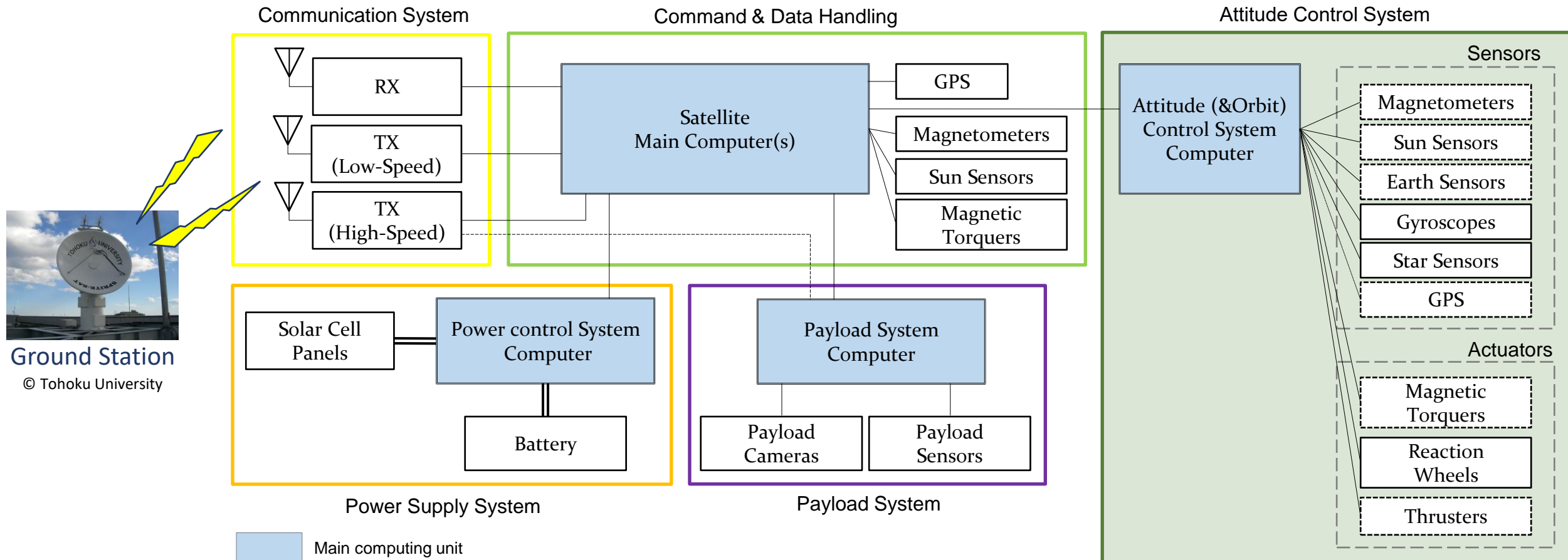

# 1. Introduction to Attitude Control System

## 1.7. Attitude Control System Design Trade-off

Attitude control methods to achieve the mission objectives shall be selected by a careful engineering trade-off process.

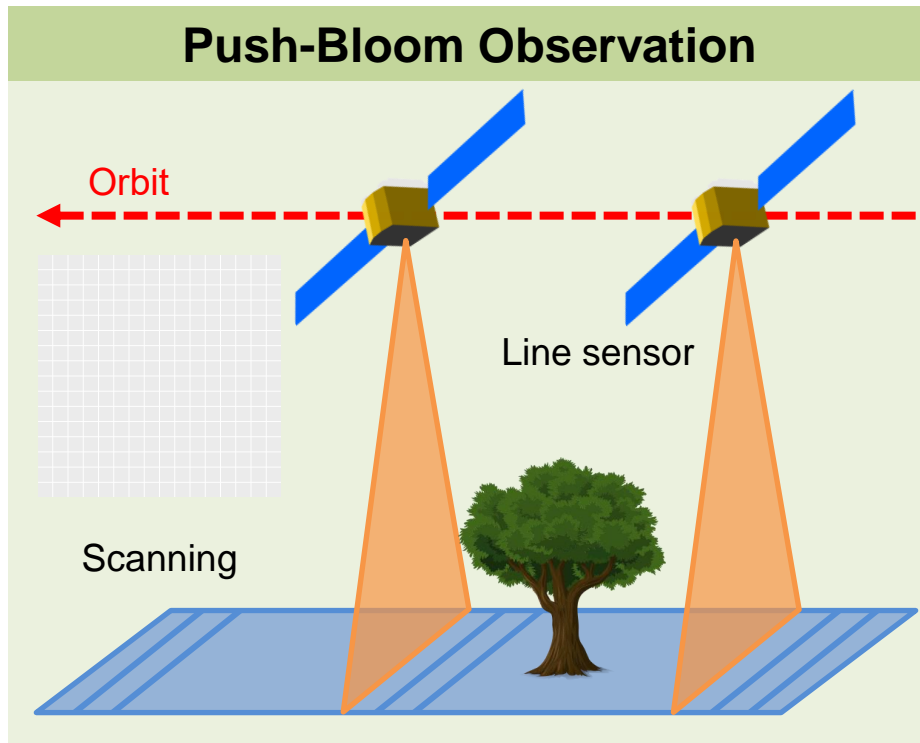

- Merit:** The attitude motion of the satellite can be kept slow  
Observation area can be larger
- Demerit:** Exposure time tends to become short.

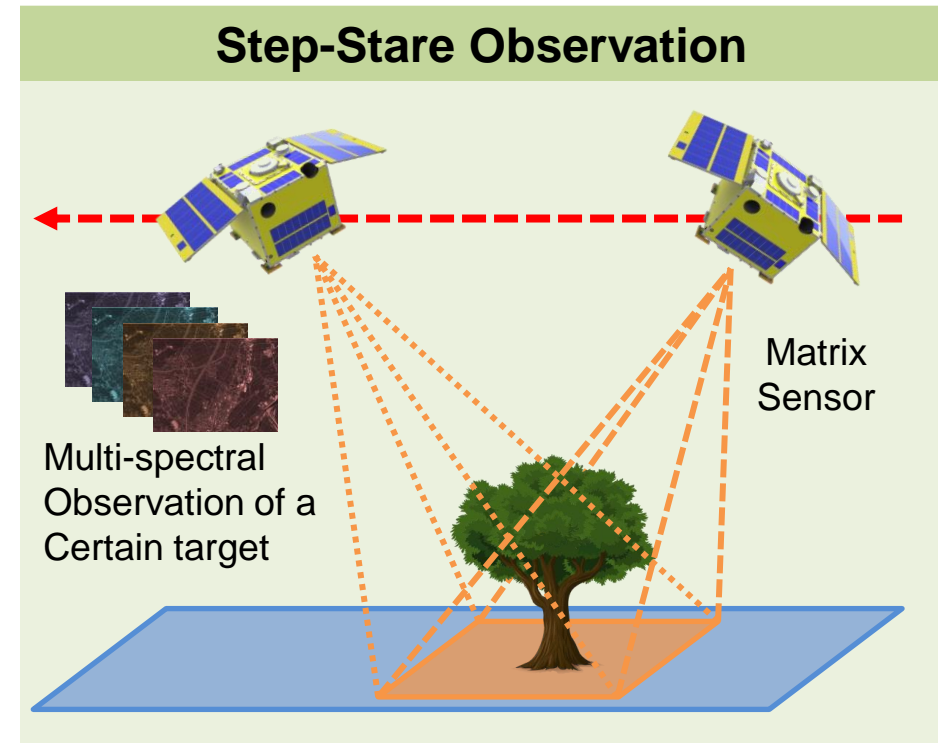

- Merit:** Exposure time can be long.
- Demerit:** Attitude control needs to be accurate and agile .  
Small observation area.

© Tohoku University

# 1. Introduction to Attitude Control System

## 1.8. Attitude Control System Example – Microsatellite RISESAT

- An example of multi-spectral observation with target pointing attitude control is illustrated below.

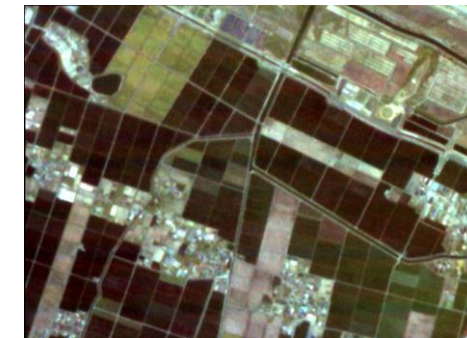
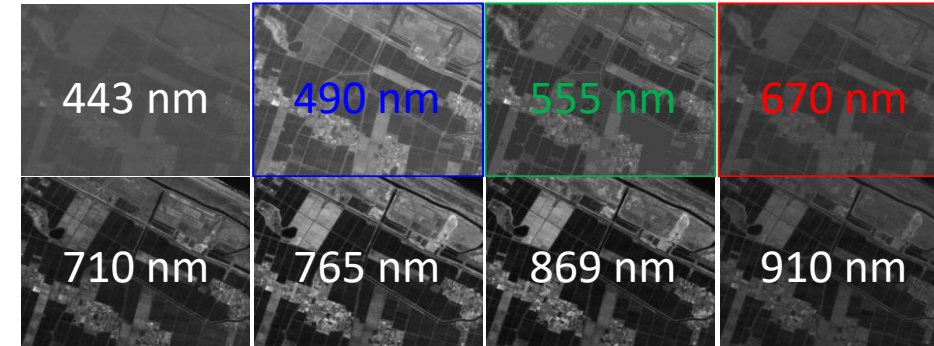

**630 Band**  
**3.7m GSD**

Sendai, True Color Composite

Multi-spectral observation with target pointing attitude control mode © JSASS

\* Fujita, S., et al.: Development and Ground Evaluation of Ground-Target Tracking Control of Microsatellite RISESAT, Trans. JSASS ATJ, 17, 2 (2019), pp.120-126.

\* Kurihara, J., Kuwahara, T., et al.: A High Spatial Resolution Multispectral Sensor on the RISESAT Microsatellite, Trans. JSASS ATJ, 18, 5 (2020), pp.186-191.





## 2. CubeSat Attitude Control Mode

# 2. CubeSat Attitude Control Mode

## 2.1. Types of Attitude Control Mode

- It is often the case that satellites need to be capable of performing specific attitude control modes in order to achieve the mission objectives.
- There are a variety of possible attitude control modes for spacecraft.
- Usually, a spacecraft is equipped with several attitude control modes, and the mode transition between them is carefully designed in order to ensure safe and stable satellite operation.

- **Types of attitude control**

1. Passive control
2. Active control

- **Attitude control modes**

- Detumbling control (after the separation from the launch vehicle or release from the ISS)
- Gravity gradient control
- Spin-stabilization control
- 3-axis control (Pointing control): Inertial, Nadir, Target, Velocity Direction, etc.

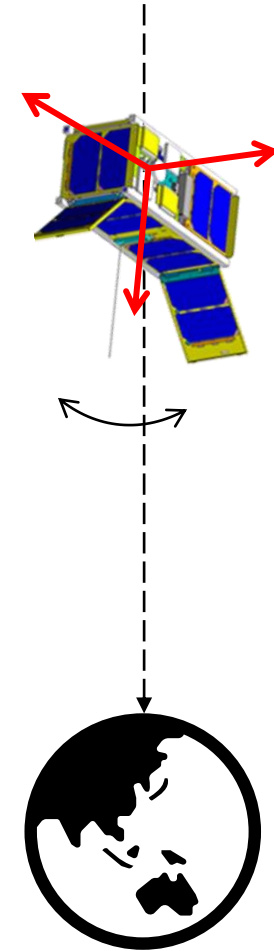

© Tohoku University

# 2. CubeSat Attitude Control Mode

## 2.2. Detumbling Control

### Detumbling Control

- Satellites can experience high rotational rates after the separation from the launch vehicle, or deployment from the ISS.
- In general, satellites in a high-speed rotation cannot communicate with the ground station properly.
- Satellites shall be able to detumble and reduce the rotational speed down to about several degrees per second.

### Type of detumbling control

#### 1. Active control

- Generate magnetic moment by means of magnetic torquers to interact with the Earth's magnetic field to actively slow down the rotational rate.

#### 2. Passive

- Utilize permanent magnets and magnetic hysteresis dumpers to passively slow down the rotational rate.

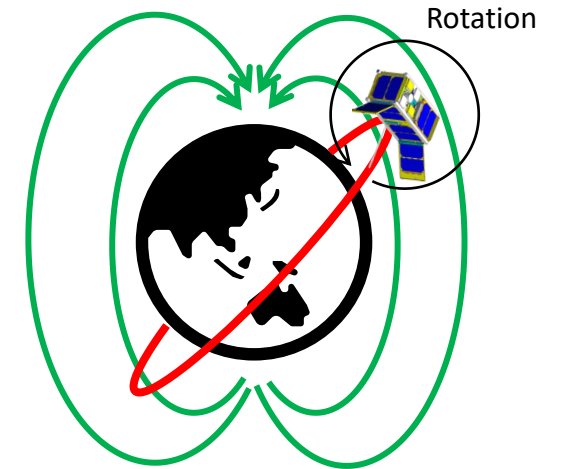

Earth Magnetic Field



Magnetic Torquers  
(Electrical Coil)

© Tohoku University

## 2. CubeSat Attitude Control Mode

### 2.3. Gravity Gradient Control

#### Gravity Gradient Control (passive control)

- Satellites with long shapes and spread mass distribution experience a gravity gradient torque such that the longitudinal direction points toward the Earth.
- Cameras, antennas, and sensors can be pointed toward the Earth without additional electrical power for the attitude control.
- Pointing accuracy is relatively low.
- Can be combined with active attitude control with some attitude control actuators, such as magnetic torquers and reaction wheels.

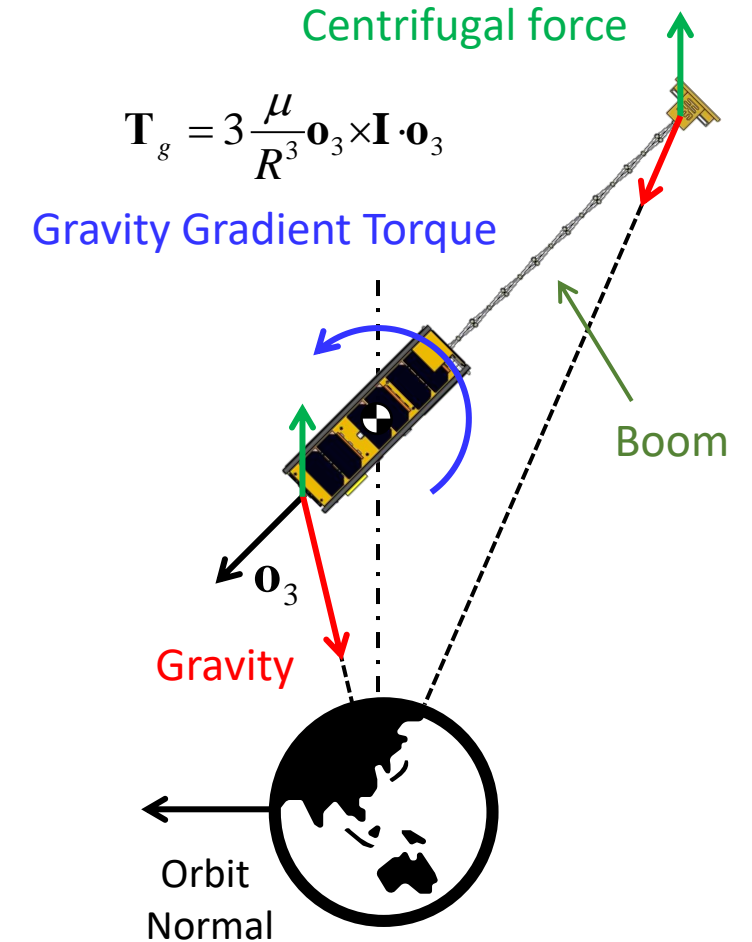

$$\mathbf{T}_g = 3 \frac{\mu}{R^3} \mathbf{o}_3 \times \mathbf{I} \cdot \mathbf{o}_3$$

Gravity Gradient Torque

$\mu$  : gravitational constant,  $R$  : orbit radius

$\mathbf{o}_3$  : observation vector (Z - axis)

© Tohoku University



# 2. CubeSat Attitude Control Mode

## 2.4. 3-axis Control (Pointing Control)

### Active 3-axis Control

- Attitude control actuators, such as magnetic torquers and reaction wheels, are used for active 3-axis control.
- Reaction wheels can realize agile and stable attitude control.
- Disturbance torques acting on the satellite gradually accumulate as angular momentum stored in the reaction wheels. Reaction wheels cannot be operated for a long time without desaturation using magnetic torquers.
- Satellite attitude shall be determined precisely by means of a combination of attitude determination sensors.

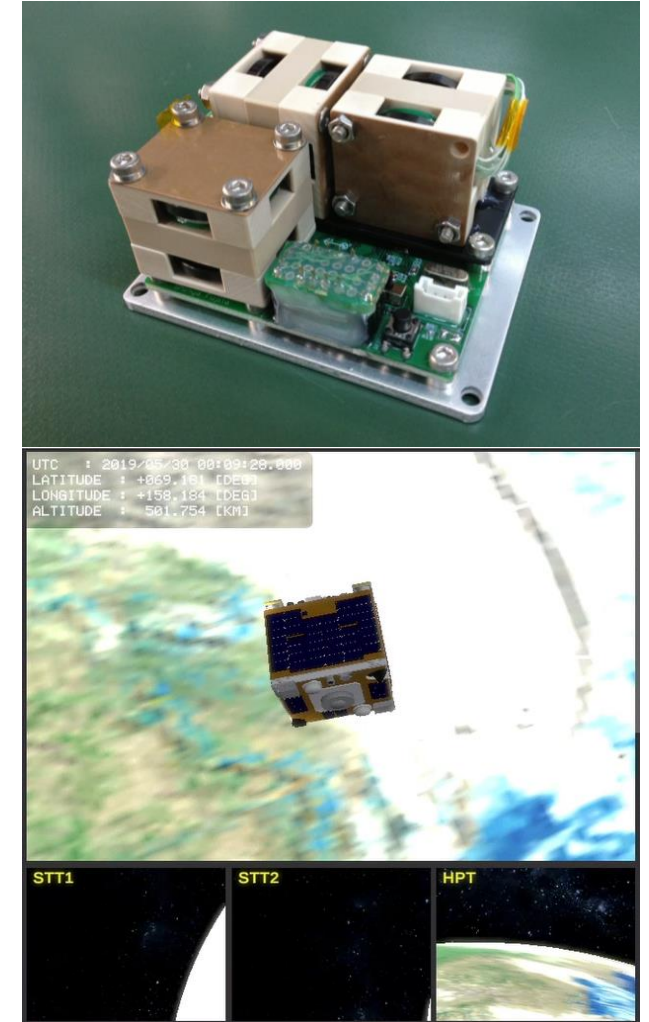

© Tohoku University

# 2. CubeSat Attitude Control Mode

## 2.5. Mode Transition between Attitude Control Modes

Example of Mode Transition State-Machine of a microsatellite, RISESAT.

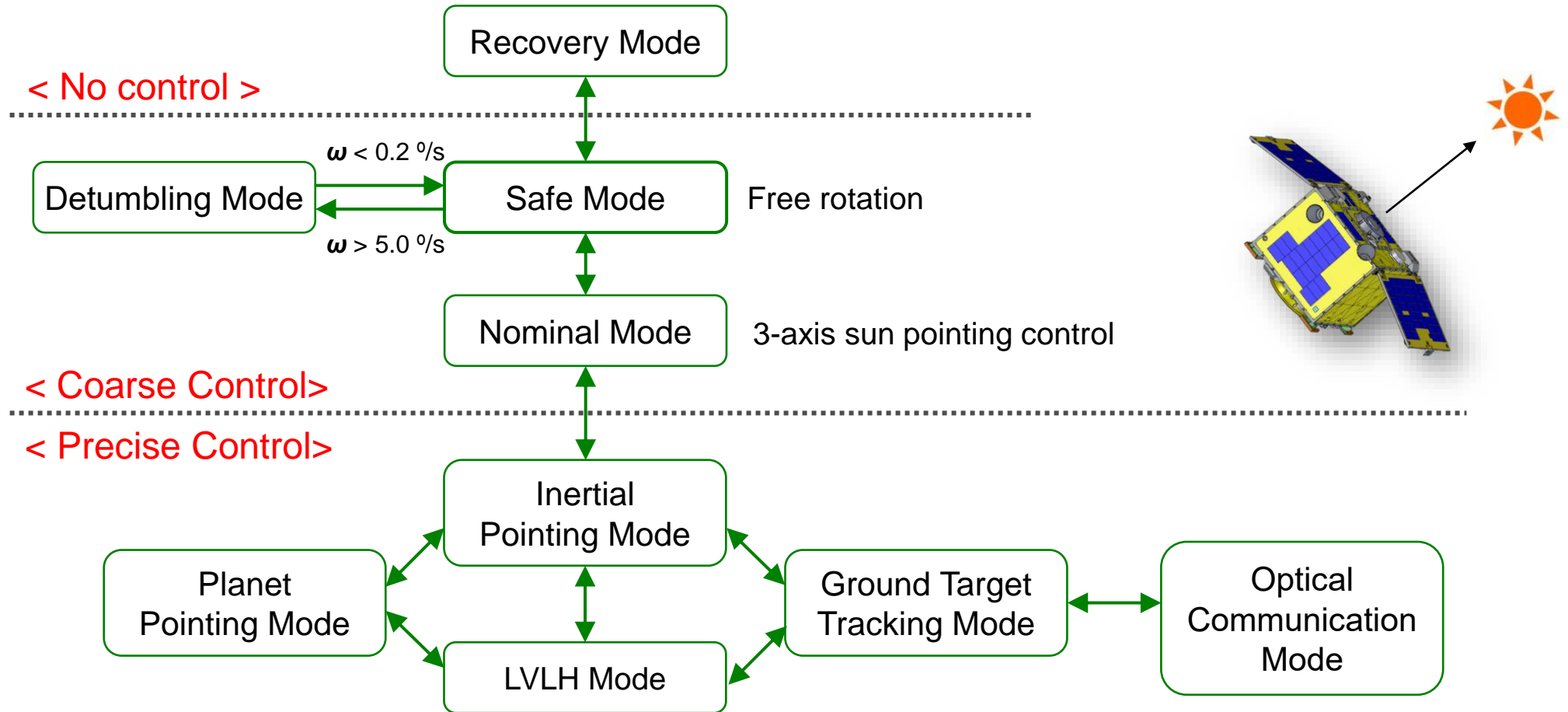

© Tohoku University



# 3. Hardware Components of Attitude Control System



# 3. Hardware Components of Attitude Control System

## 3.1. Introduction to Hardware Components of Attitude Control System

- Attitude control system (ACS) requires attitude determination sensors, attitude control actuators, and on-board computers. A satellite can have a dedicated computer for the ACS or ACS functionalities can be spread into several on-board computers.
- ACS requires a lot of on-board components and significant efforts are needed for their verification. Definition of their requirements and “make or buy” decisions have considerable impacts on project progress and mission successes.

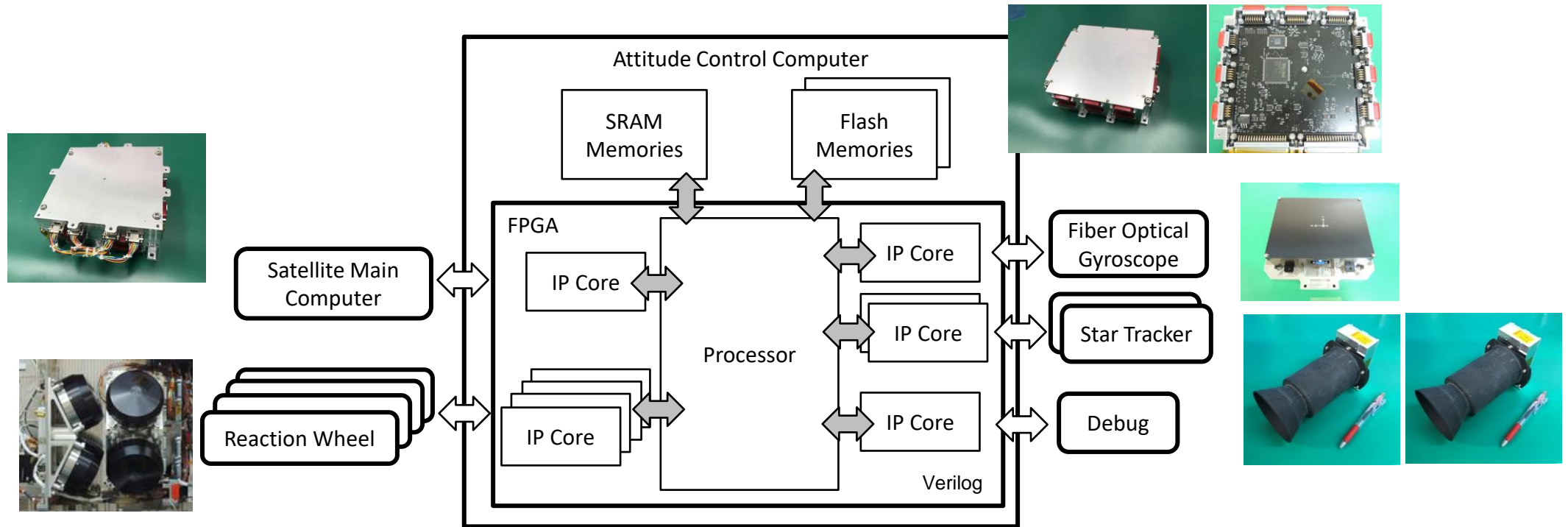

© Tohoku University



# 3. Hardware Components of Attitude Control System

## 3.2. Attitude Determination Sensors

- Sensor instruments and their corresponding variables, which are used for spacecraft attitude determination, are listed below.

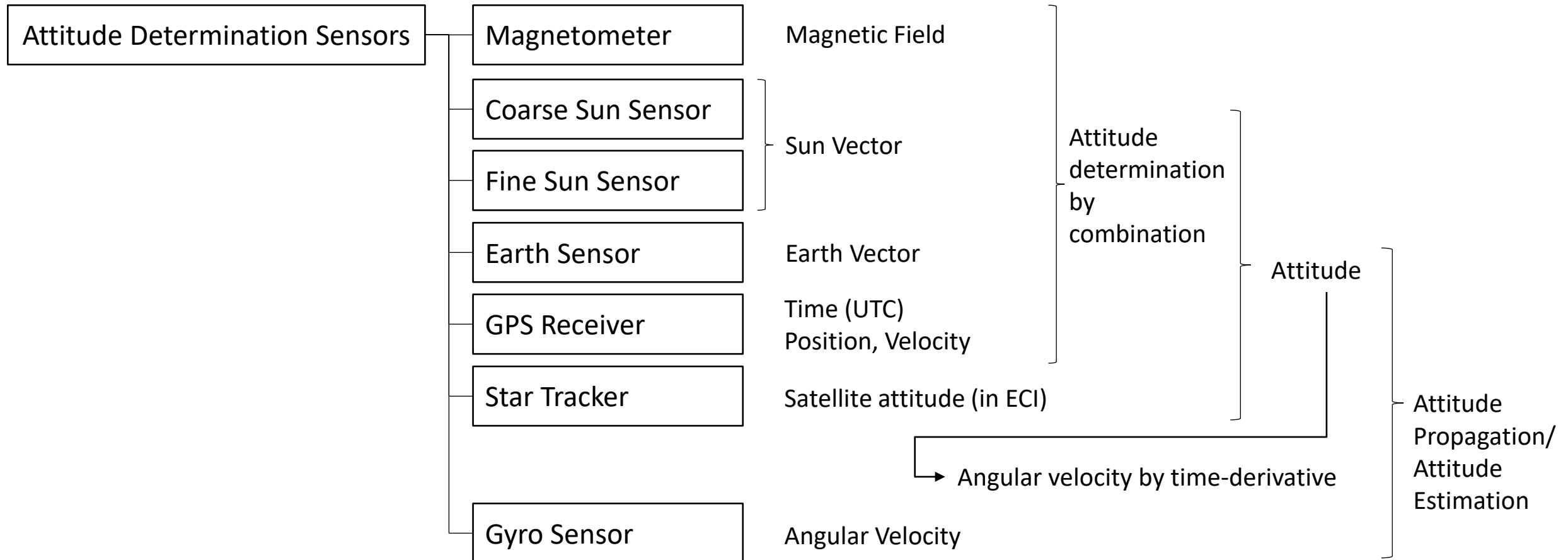

# 3. Hardware Components of Attitude Control System

## 3.3. Attitude Determination Sensors – Magnetometer

- Magnetometer / Geomagnetic Aspect Sensor
  - Measure the direction of the Earth's magnetic field.
  - Used to determine the attitude of the satellite by comparing the measured value and the calculated Earth magnetic field model at the position of the satellite.
  - Since it is affected by the magnetic field generated by the satellite itself, it is necessary to check whether there are any devices that consume a large current in the neighborhood of the sensor and whether the residual magnetic moment of the satellite is small enough.
  - It is beneficial that magnetic field information is available for Low Earth Orbit satellites all the time.
  - Especially, it is necessary to know the direction of the Earth's magnetic field for attitude control using magnetic torquers.
  - Some magnetometers have analog outputs and some have digital outputs.

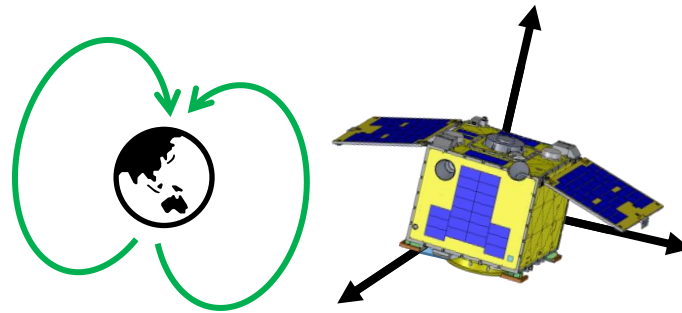

Magnetometer



© Tohoku University

# 3. Hardware Components of Attitude Control System

## 3.4. Attitude Determination Sensors – Coarse Sun Sensor

### • Coarse Sun Sensor / Sun Aspect Sensor

- Small solar cells or photodiodes can be used as the coarse sun sensor.
- The amount of power generated by the sensors changes according to the angle of incidence of sunlight, which is converted into voltage for measurement.
- By measuring the ratio of six sensors that are orthogonal to the three axes, the direction of the sun can be determined with coarse accuracy (several degrees).
- It is very robust and stable.
- It has a wide field of view and can cover the entire sky.

Coarse Sun Sensor Implementation based on Solar Cells.

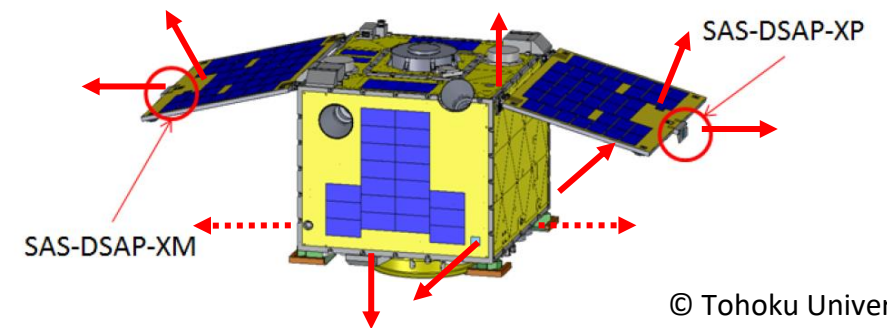
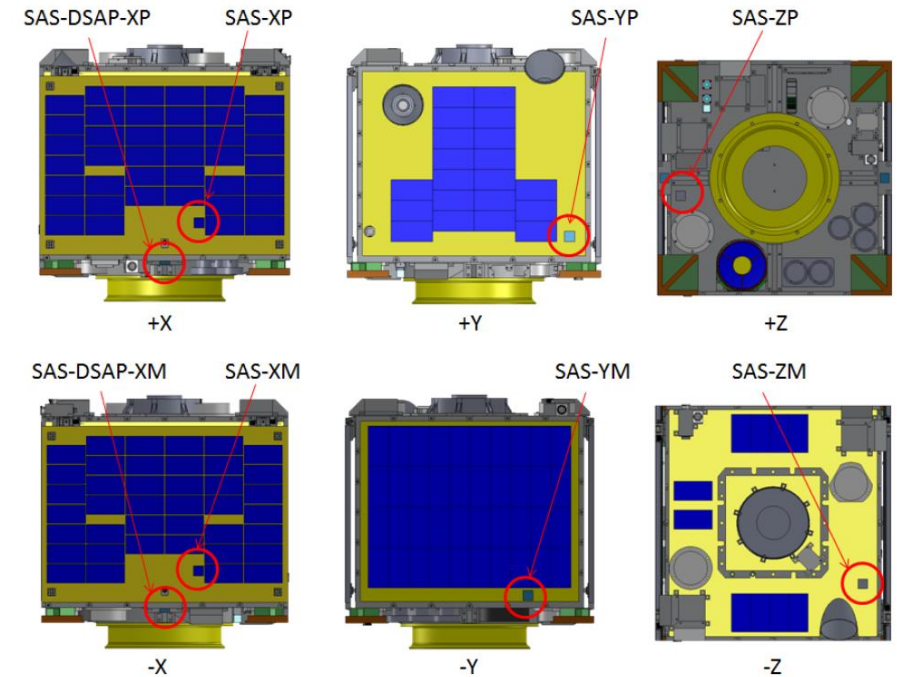

© Tohoku University

# 3. Hardware Components of Attitude Control System

## 3.5. Attitude Determination Sensors – Fine Sun Sensor

- Fine Sun Sensor

- Can detect the sun direction very accurately.
- There are various principles, such as slit type and pinhole type.
- The field of view is narrow, and it is necessary to mount multiple sensors to cover the entire sky.
- In the example illustrated in the figure on the right, two sets of solar sensors are mounted on the upper and lower surfaces of the satellite, each of them having a pair of two sun sensors in order to cover the entire sky.
- If the attitude of the satellite to the sun is restricted in advance, it can be handled by a reduced number of sensors.
- Can only be used in the sunshine area.

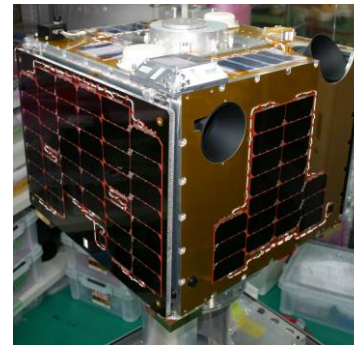

Fine Sun Sensor

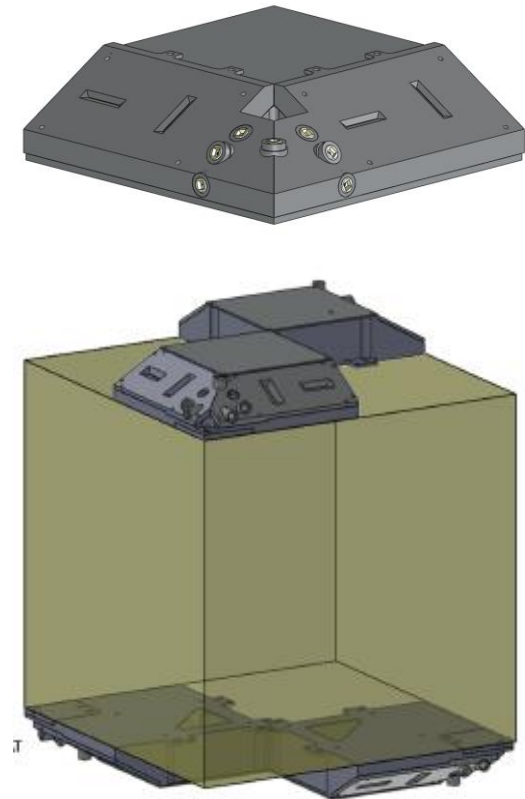

© Tohoku University



# 3. Hardware Components of Attitude Control System

## 3.6. Attitude Determination Sensors – Earth Sensor

- Earth Sensor

- Some use optical sensors to determine the direction of the earth by detecting the rims of the Earth, while others use heat-sensitive sensors, such as thermopiles.
- In Low Earth Orbit, Earth exists too close to the satellite to determine the direction accurately, and Earth sensors is not widely used.
- The figure on the right is an example of an Earth sensor implementation example using thermopiles (still under investigation).
- There is a demand for detecting the geocentric direction, even with coarse accuracy, in the eclipse.

Earth Sensor

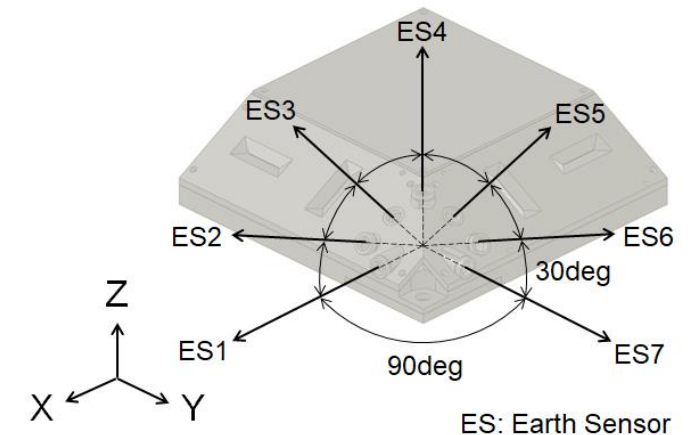
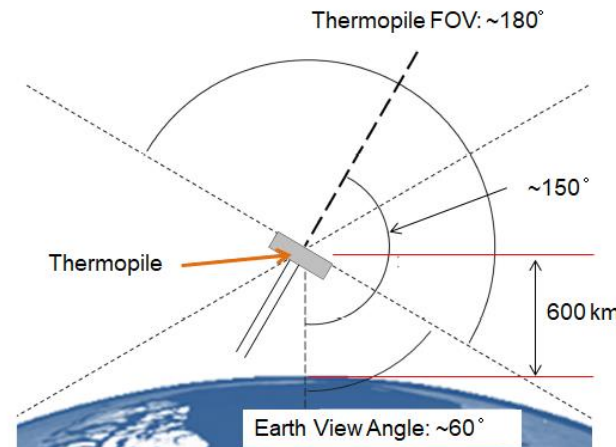

© Tohoku University

# 3. Hardware Components of Attitude Control System

## 3.7. Attitude Determination Sensors – Star Tracker

### • Star Tracker / Star Sensor

- Takes images of star constellation and compares with the star catalog information to determine the attitude of the sensor relative to the inertial coordinate.
- The satellite attitude can be directly determined by single sensor very accurately.
- After successfully detecting the attitude at the beginning (lost in space) when the power is turned on, it tracks and follows the identified stars to keep determining the satellite attitude.
- Required exposure time is relatively long (typically several hundreds of milliseconds) to get clear star images, which limits the processing speed and sensor data output frequency.
- The challenge is to perform a catalog matching process as fast as possible in order to reduce the data latency.
- It is necessary to design the lifetime of the sensor in consideration of the deterioration of the sensor over time and the increase of white pixels.
- By blocking the intrusion of ambient light using a baffle, the satellite's activity region can be expanded and flexible operation can be realized.
- Attitude cannot be detected when the angular velocity of the satellite is too high.

Star Tracker



© Tohoku University

# 3. Hardware Components of Attitude Control System

## 3.8. Attitude Determination Sensors – GPS Receiver

- GPS Receiver, Antenna

- GPS receivers can also be used in Low Earth Orbit.
- GPS receivers provide information such as:
  - Time (UTC), and PPS (Pulse Per Second)
  - Satellite position
  - Satellite velocity
- Since the relative velocity is faster in orbit than on the ground, it is necessary to use GPS receivers designed for space-use.
- For satellites whose attitude may be oriented in any direction, it is better to mount a receiving antenna on the upper and lower surfaces of the satellite so that GPS signals can be received regardless of the attitude. Antennas on the upper and lower surfaces can be coupled as a single antenna (right figure).
- It is better to select a GPS that has a short acquisition time after power on.
- On-board processing of GPS data needs attention of leap years.

### GPS Receiver and Antenna

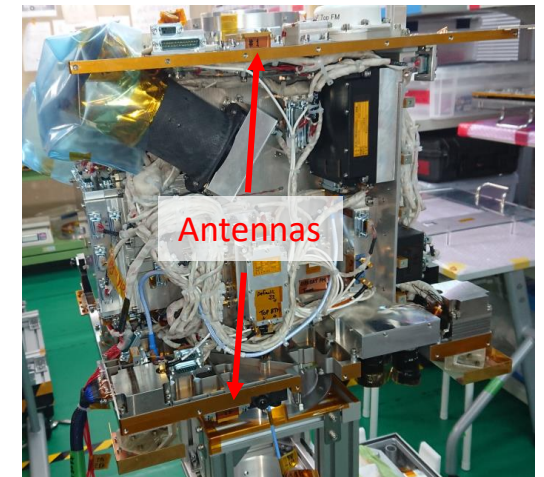
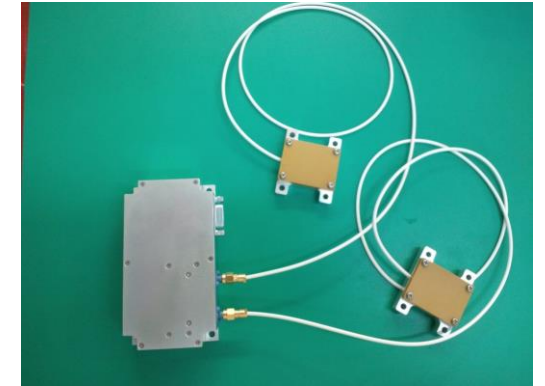

© Tohoku University

# 3. Hardware Components of Attitude Control System

## 3.9. Attitude Determination Sensors – Gyro Sensor

### Angular rate/velocity sensor

- Fiber Optic Gyroscope (FOG)
  - A high-precision angular velocity sensor used for microsatellites.
  - Optical fiber is used inside and the device, the lifetime shall be evaluated paying attention to the optical deterioration due to radiation effects.
  - Several degrees of accuracy can be achieved even after just about 1 hour of numerical integration.
- MEMS Gyro Sensor
  - Middle-precision angular velocity sensor used for microsatellites.
  - Since it has excellent durability and a small form factor, it is suitable for building a redundant system or as a backup in the event of a failure.
  - When using FOG, it is recommended to install MEMS Gyro Sensor as well for redundancy.

### Fiber Optic Gyroscope



© TAMAGA SEIKI

### MEMS Gyro Sensor



© Sensoror



# 3. Hardware Components of Attitude Control System

## 3.10. Attitude Control Actuators

- Actuator instruments for the spacecraft attitude control are listed below.

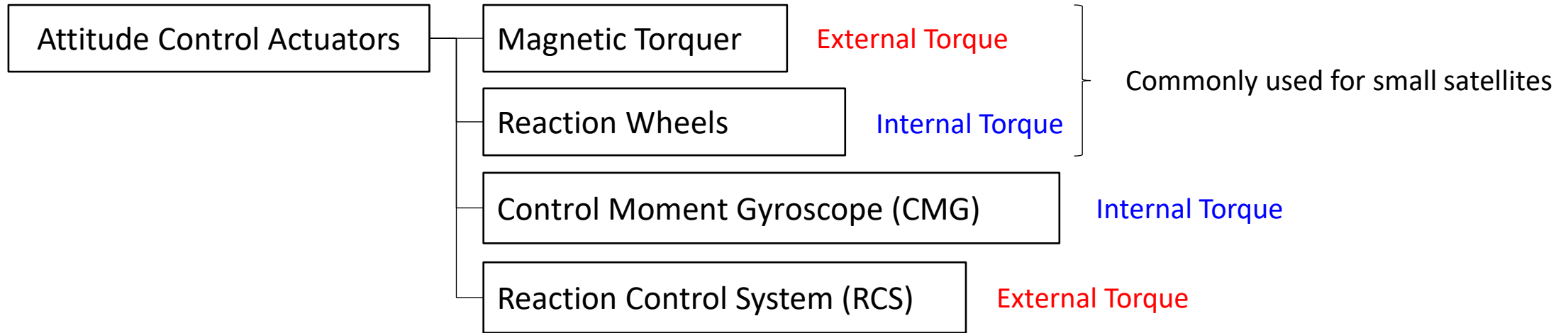

- Reaction wheels and CMGs can generate internal torques electronically by means of reaction torques generated from rotating elements inside of them.
- External disturbance torques acting on spacecraft are accumulated in forms of their angular momentum which needs to be desaturated using actuators with external torques.
- Satellite attitude can also be controlled using only actuators with external torques.

# 3. Hardware Components of Attitude Control System

## 3.11. Attitude Control Actuators – Magnetic Torquer

### • Magnetic Torquer

- A device that can generate a magnetic moment by electrical current.
- The generated magnetic moment interacts with the Earth's magnetic field resulting in external torque acting on the satellite.
- It can only be used in space where magnetic field exists.  
(Cannot be used in Lunar orbit)
- It is common that a satellite is equipped with three magnetic torquers in each axis, so that the satellite can generate the desired magnetic moment for 3-axis attitude control.
- It is also used for the detumbling control of the satellite rotational velocity, especially after the separation from the launch vehicle, or release from the International Space Station (ISS). Detumbling can be achieved by a few number of magnetic torquers.

Magnetic Torquer

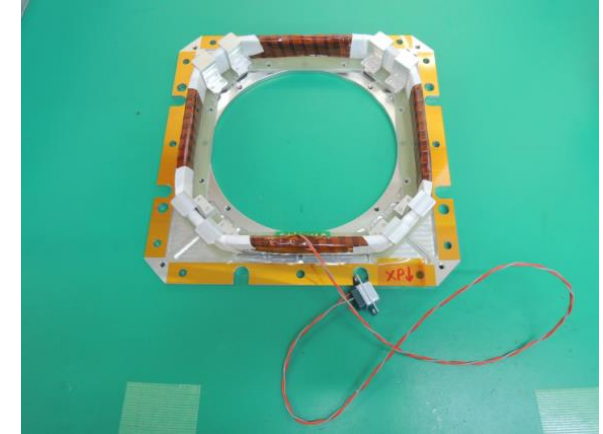

© Tohoku University

# 3. Hardware Components of Attitude Control System

## 3.12. Attitude Control Actuators – Reaction Wheel

- Reaction wheel

- A reaction wheel contains a rotating wheel inside and makes it possible to control the attitude of the spacecraft by the reaction effects of the rotation.
- Internal torque can be generated electronically and no propellant is needed, unlike thrusters.
- In many cases, about 1 to 4 units will be installed in a spacecraft according to the mission requirements.
- The performance of RWs is explained by the magnitude of output torque and the maximum angular momentum that can be accumulated.
- The internal wheel can be rotated in either the positive or negative direction.
- The wheel stops once when the direction of rotation changes. This situation is called “zero-cross”, and when this happens, the accuracy of attitude control and the lifetime of the internal mechanical elements, decreases.
- When aiming for long-term use preventing deterioration of bearings, it is necessary to avoid zero-cross in operation.
- There is a practical upper limit of the rotational speed of the internal wheel, such as up to around 3000 rpm.

Reaction Wheel



© TAMAGA SEIKI

# 3. Hardware Components of Attitude Control System

## 3.13. Attitude Control Actuators – Reaction Control System / Thruster

- Reaction Control System (RCS)
  - An attitude control system which utilizes several sets of thrusters.
  - RCS requires propellant, and hence the amount of propellant limits the device lifetime.
  - The same set of thrusters of RCS could be also used for the orbit control, depending on their alignment.
  - A pair of two thrusters are required in order to generate only torque without generating translational thrust.
  - There are different kinds of thrusters available for RCS.
    - Cold gas thruster
    - Hot gas thruster
    - Resistojet thruster
    - Ion thruster
    - etc.



Micro-satellite ALE-2 © ALE / Tohoku University





# 4. Attitude Determination and Control Process

# 4. Attitude Determination and Control Process

## 4.1. Introduction to Attitude Determination and Control Process

- Attitude determination and control processes can be divided into several steps, executed one after another in a periodical manner continuously.
- The process consists of processing of sensor data, orbit determination, attitude determination, guidance, attitude control calculation, and the generation of command packets for actuators.

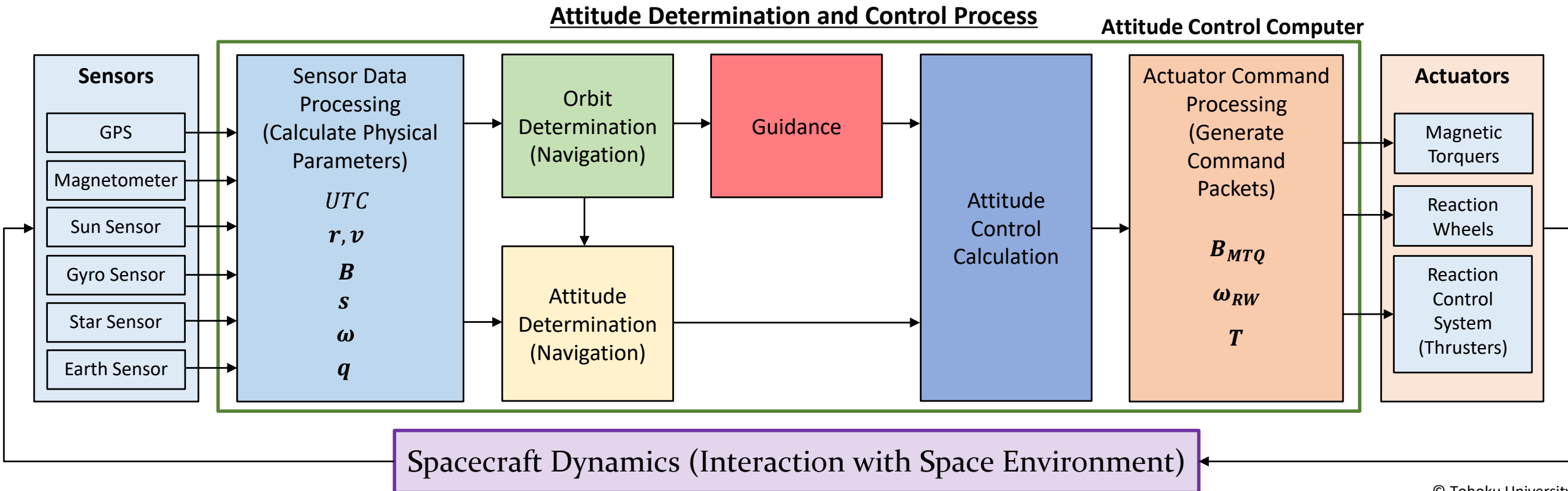

© Tohoku University

# 4. Attitude Determination and Control Process

## 4.2. Detailed Block Diagram of Attitude Determination and Control Process

- Guidance, Navigation and Control Classification of the Attitude Determination and Control Process.

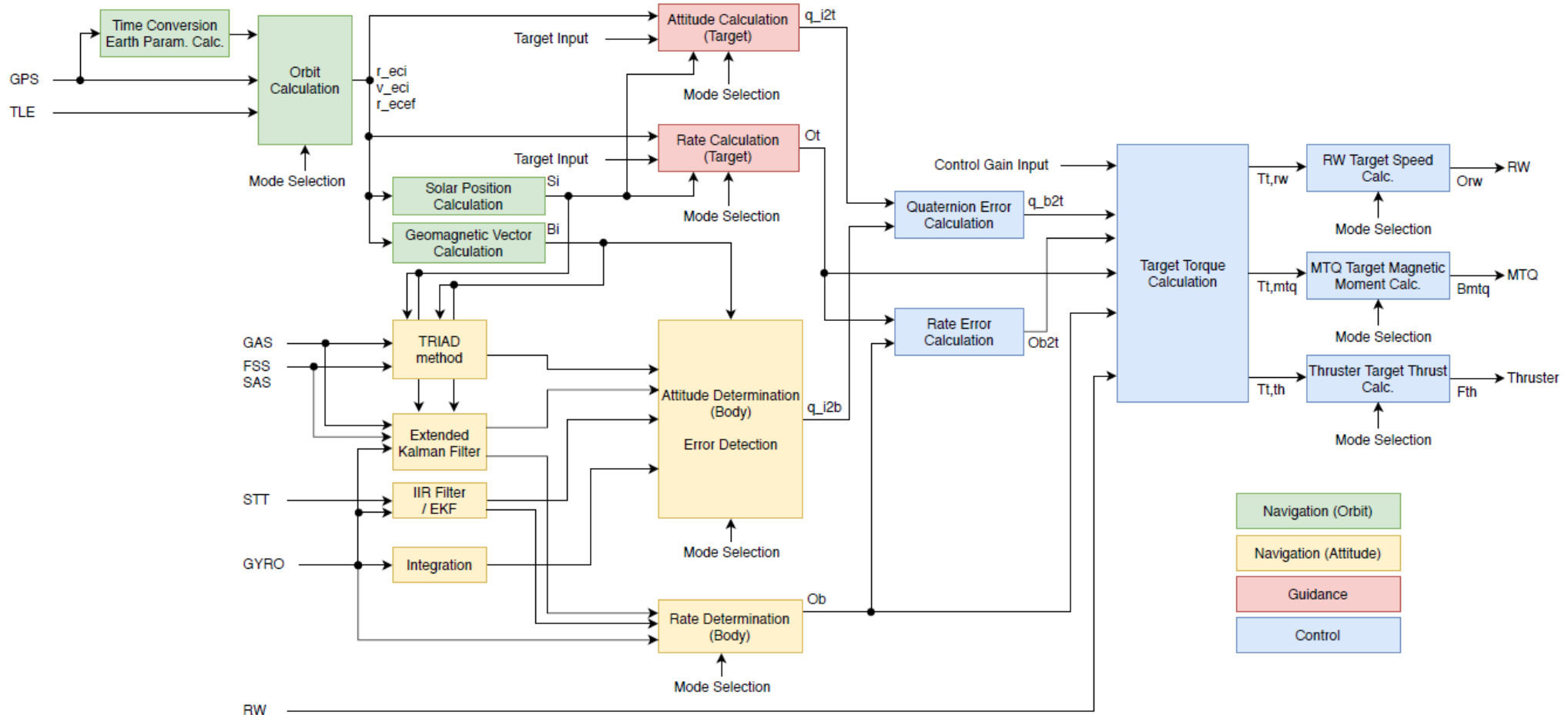

# 4. Attitude Determination and Control Process

## 4.3. Attitude Determination

- For the attitude determination, the following information shall be available.
  - Time Information – Time information can be obtained from the GPS receiver, or from the on-board RTC.
  - Orbital Position – Orbital Position can be obtained from the GPS receiver, or mathematical integration inside the on-board computer based on the orbital mechanics. TLE (Two Line Element) information can be used.
- Attitude determination calculations requires comparison between the measured physical parameters and estimation with space environmental models.
  - Sun direction
  - Magnetic field direction (Earth rotation)
  - Earth direction

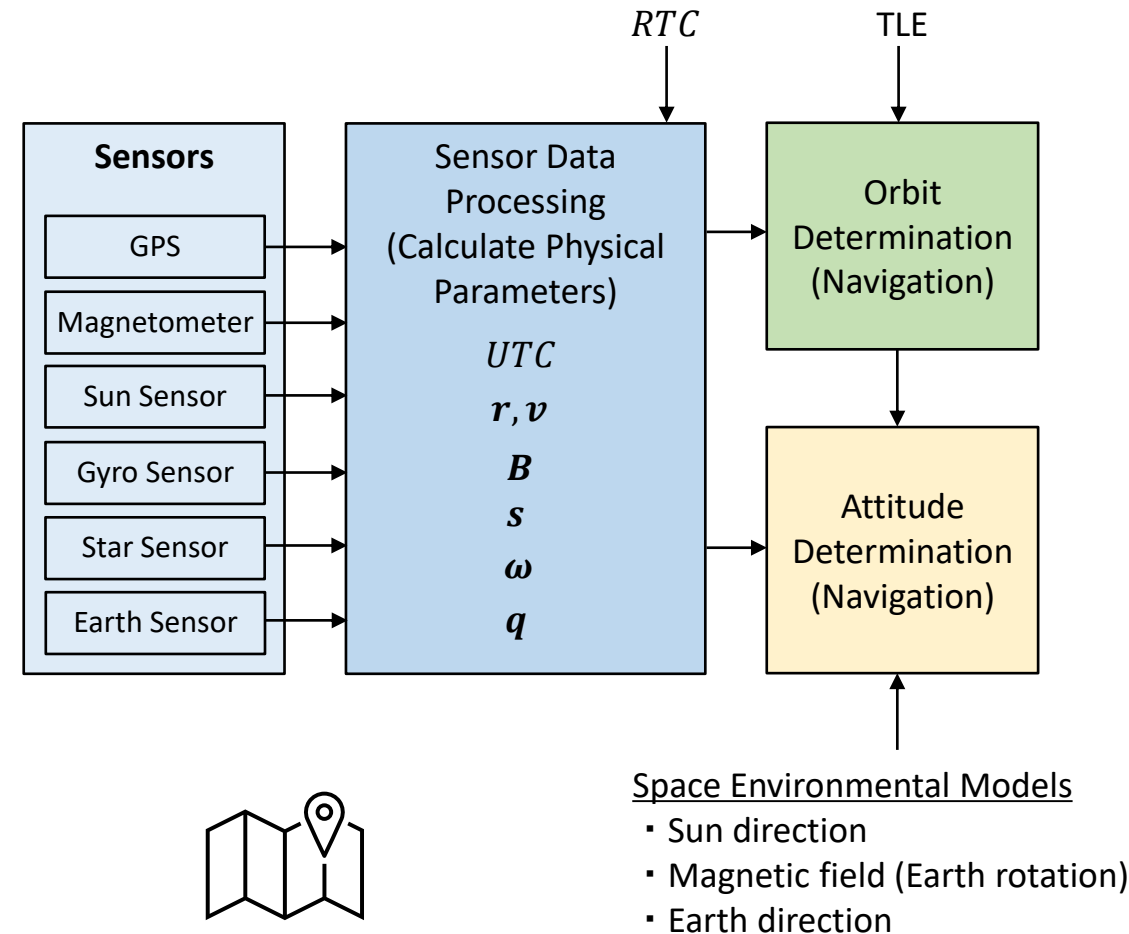



# 4. Attitude Determination and Control Process

## 4.5. Navigation

- Before the attitude control processing, the target attitude of the satellite needs to be calculated.
- The target attitude and rotational rate as well as their precision, depend on the mission objectives. There are a variety of target attitude definitions based on the mission objectives.
- Attitude determination and control is usually discussed relative to the inertial coordinate system.
- There are several different types of pointing controls as below:
  - **Inertial Pointing Mode** – Spacecraft attitude is controlled in the way that it is fixed to a certain direction of the inertial coordinate system. It is often used for star observation.
  - **Nadir Pointing Mode** – Spacecraft attitude is controlled in the way that a certain axis keeps pointing to the Earth (or a certain celestial body) center direction. It is often used for Earth surface observation in a scanning mode. The target attitude rotates with time based on the relative position of the Earth and the satellite.
  - **Ground Target Pointing Mode** – Spacecraft attitude is controlled in the way that a certain axis keeps pointing to a certain target object on the Earth's surface. It is often used for Earth observation in a pointing mode, or high-speed communication between the target ground station.

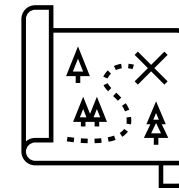
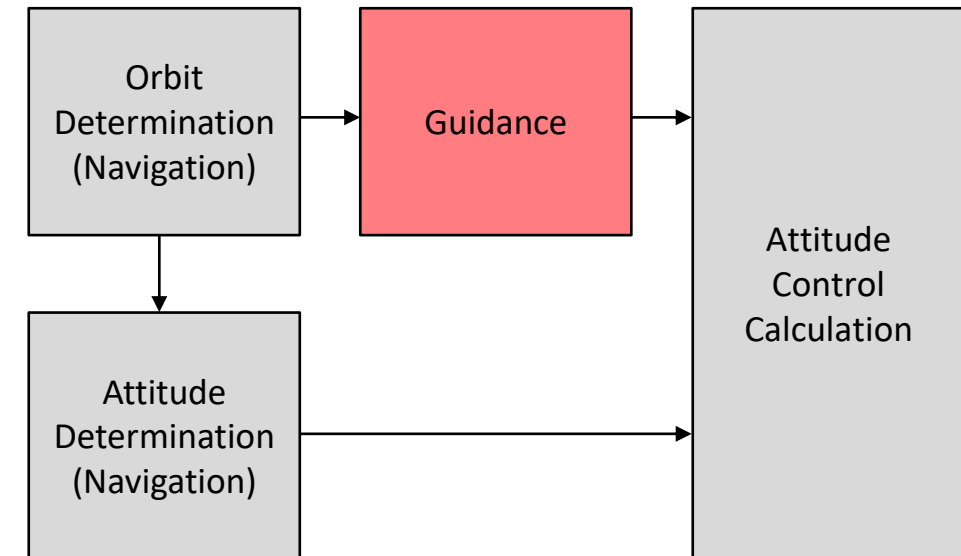

# 4. Attitude Determination and Control Process

## 4.10. Attitude Control

- Current attitude error is measured by comparing the target coordinate system and current body coordinate system, and attitude control torque is generated in the way that the attitude error decreases in order to achieve the desired attitude.
- Accuracy of the attitude control depends on the accuracy of attitude determination. Usually, the attitude determination accuracy shall be more than 10 times better than the desired attitude control accuracy.
- The limitation of the performance of the actuators and their mechanical alignment shall be taken into account when generating the actual commands sent to the hardware components.
- Spacecraft attitude can be controlled both by internal forces, such as the torque generated by reaction wheels, and external forces, such as the torque generated by magnetic torquers and thrusters.

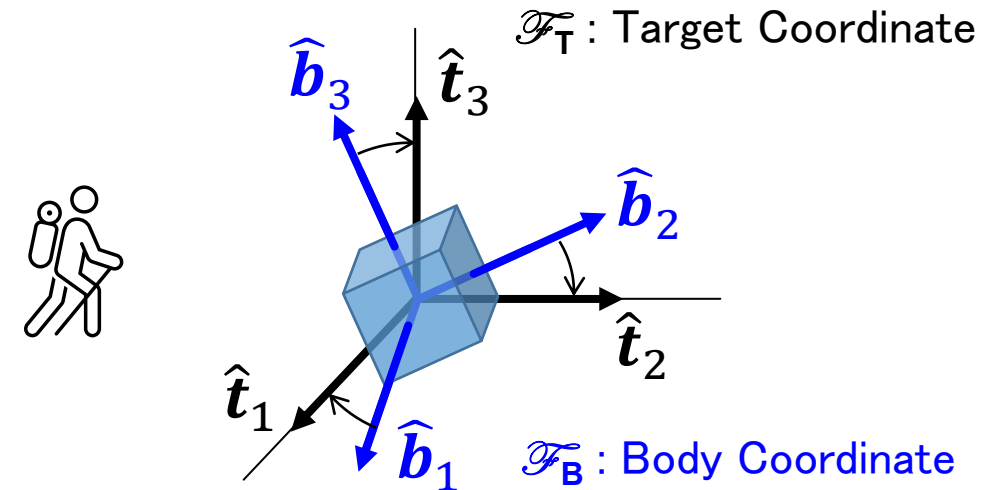
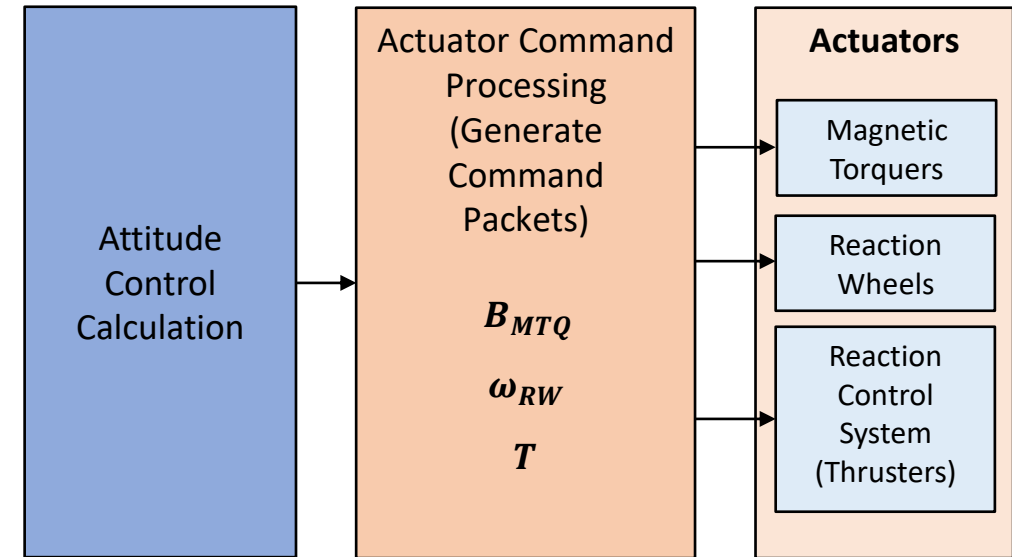

# 5. Attitude Determination and Control Algorithms

## 5.14. Attitude Control

- Two examples of quaternion feedback control applications are illustrated below.
  - Attitude control for target pointing Earth observation
  - Attitude control for laser communication

### Target Pointing Earth Observation

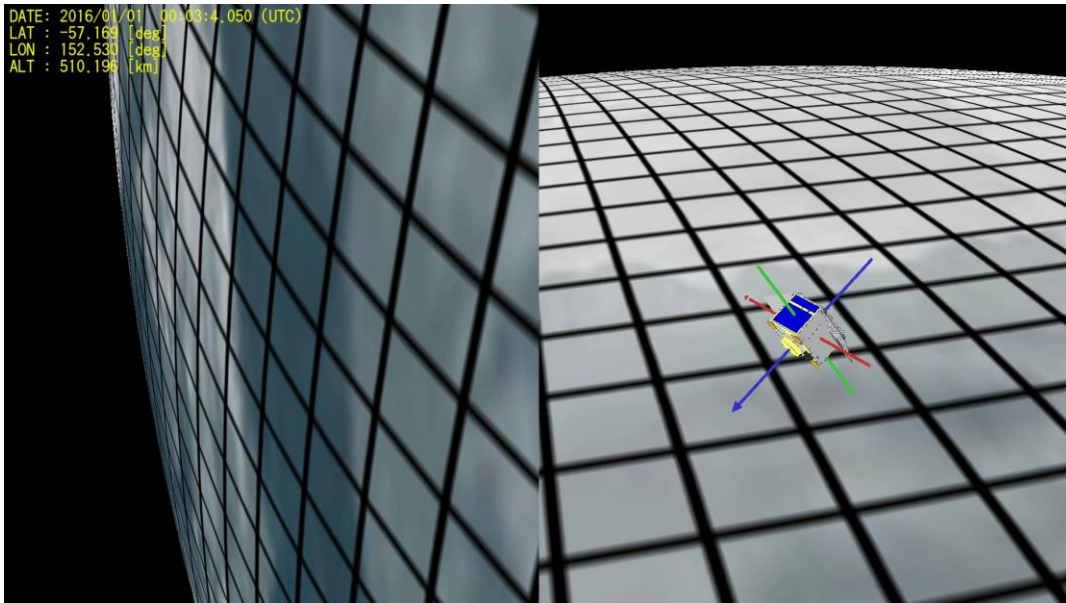

© Tohoku University

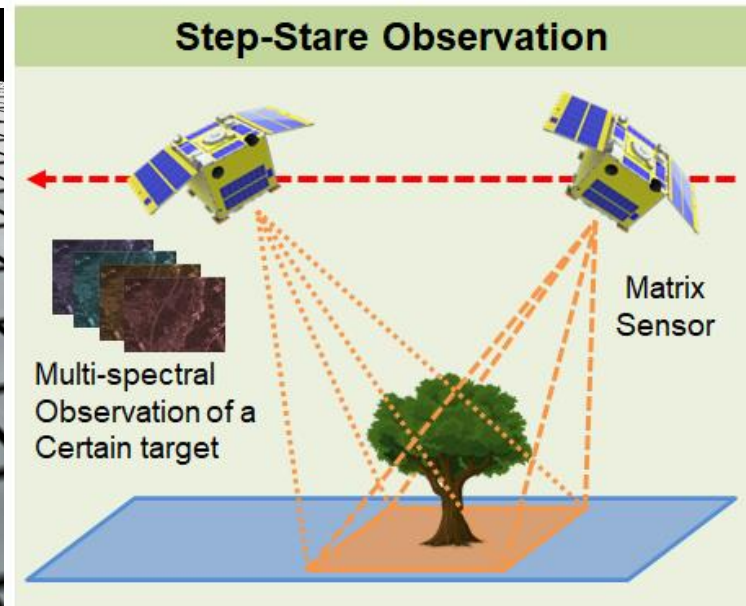

### Laser Communication

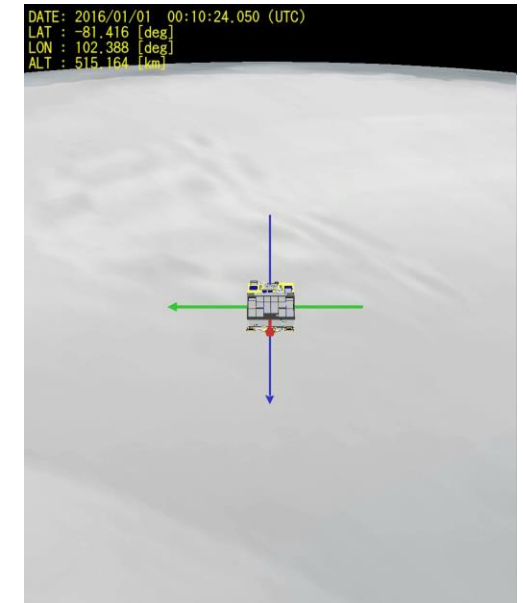

© Tohoku University





# 6. Functional Verification of Attitude Control System



# 6. Functional Verification of Attitude Control System

## 6.1. Electrical Testing

- Ground testing facilities are required to conduct tests of electrical functionalities of the satellite components and satellite system, and are especially indispensable for the evaluation of attitude control algorithms and performance verification.
- Software-based simulators are utilized for hardware-in-the-loop tests in real-time in order to verify the correct functionalities of on-board software running on the actual flight hardware.

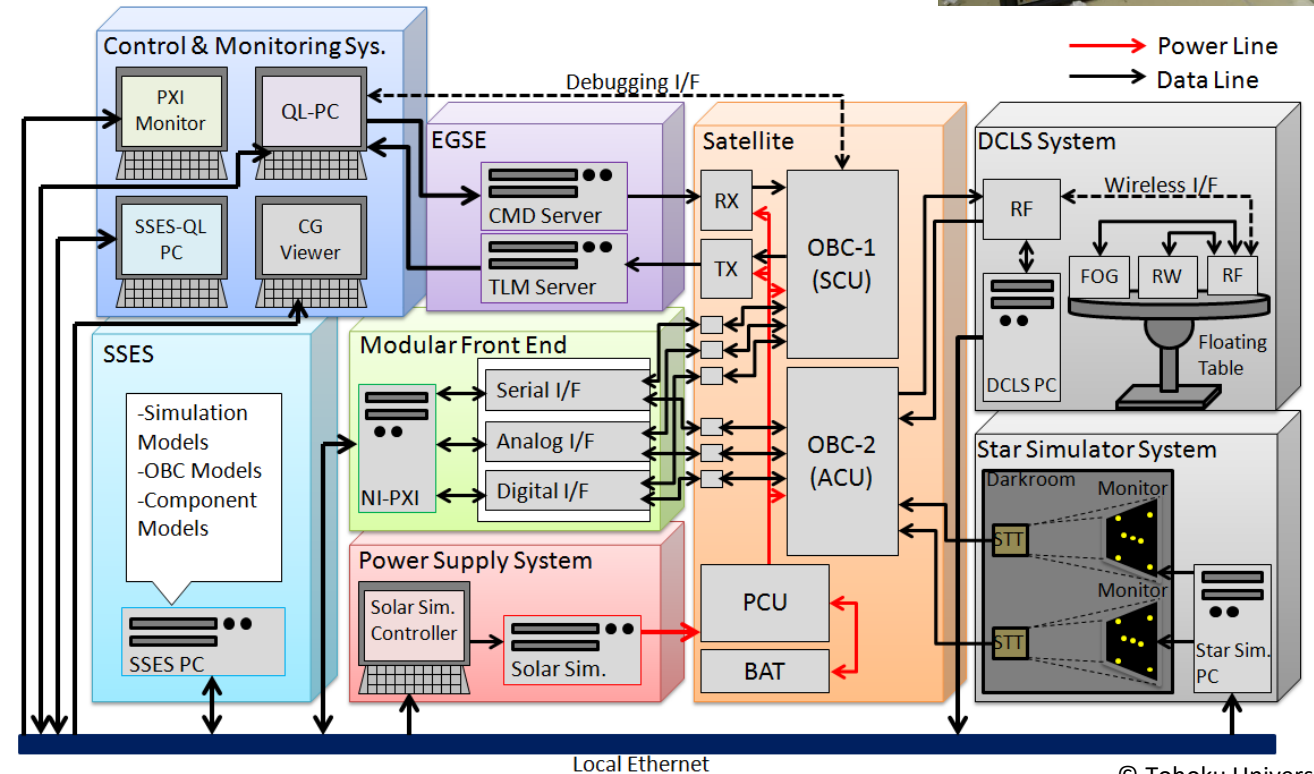
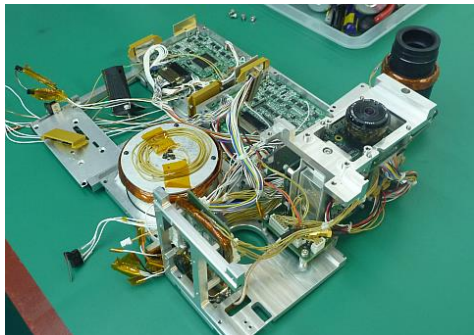

© Tohoku University

# 6. Functional Verification of Attitude Control System

## 6.2. Precise Implementation of Software Models of Sensors and Actuators

### Hardware-in-the-Loop Test Environment

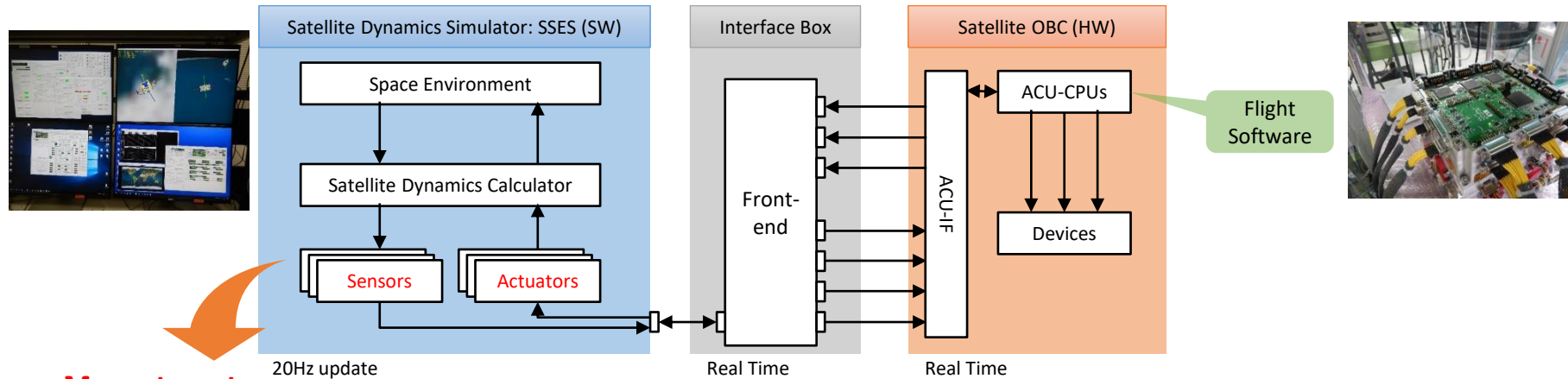

#### Magnetometer

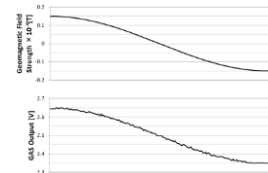
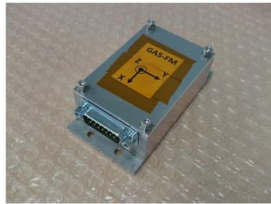

Analog output

#### Sun Sensors

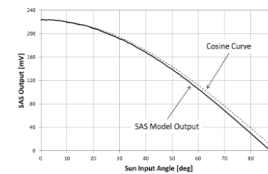
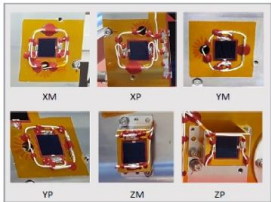

Analog output

#### Gyro Sensor

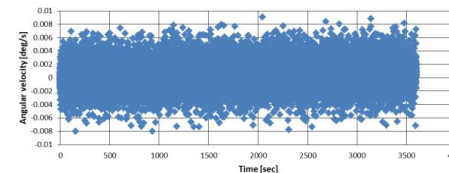
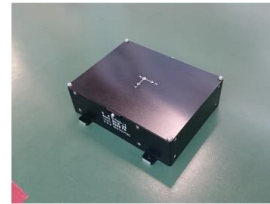

Random noise

#### Reaction Wheel

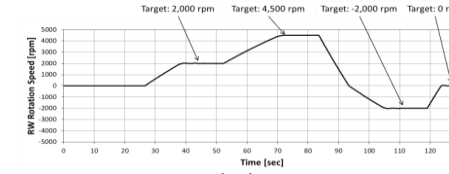

Rotational characteristics

© Tohoku University

The precision of the sensor and actuator models shall be improved through the ground tests and orbit operation heritage.

# 6. Functional Verification of Attitude Control System

## 6.3. Software Simulation

- Full software simulators are very useful for the simulation of the satellite's orbital and attitude behavior.
- The simulation process can be accelerated to conduct a large number of simulation trials.
- On-board software can be developed using this kind of simulation, software development, and verification environment.

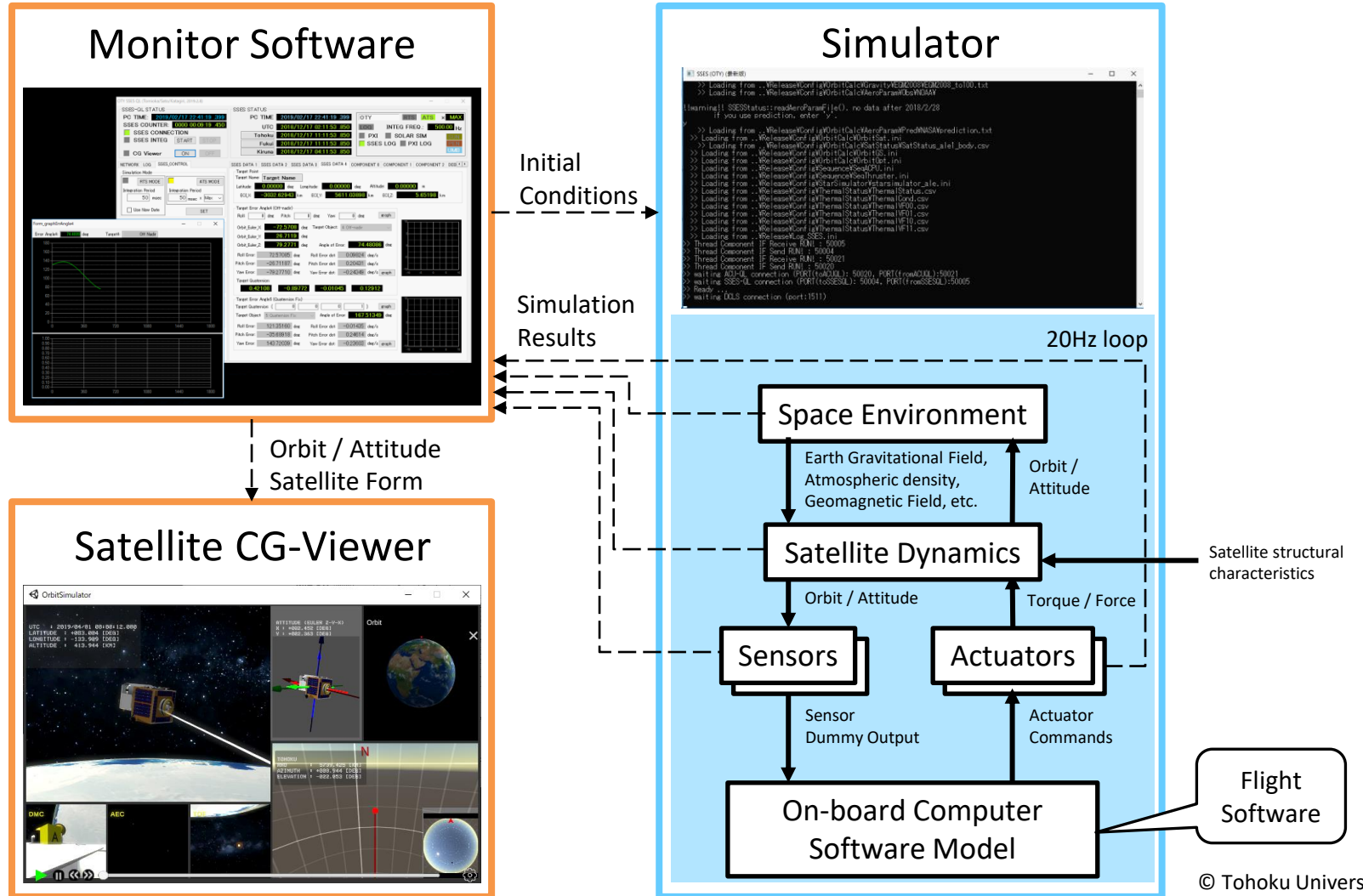





# 7. Conclusion



# 7. Conclusion

- Introduction to CubeSat attitude control system is provided. It was explained that the attitude determination and control process consists of several steps, such as navigation, guidance, and control, and that attitude control and orbit control influence each other.
- Various kinds of attitude control modes and an example of attitude control system state machine diagram with mode transitions are introduced.
- Hardware components of the attitude control system were introduced, such as attitude determination sensors, attitude control actuators, and attitude control system computers.
- Processing tasks of navigation, guidance, and control are described in detail.
- Functional verification aspects of the satellite attitude control system were described. Several verification and simulation infrastructures were introduced, and the importance of operational planning of attitude control systems based on the satellite and the space environment simulator, was emphasized.



**Thank you very much.**

[Disclaimer]

The views and opinions expressed in this presentation are those of the authors and do not necessarily reflect those of the United Nations.