



UNITED NATIONS
Office for Outer Space Affairs



DropTES 9th round Announcement of Opportunity Webinar



21 June 2023
10:30 & 16:30 CEST



Access to Space for All

DropTES - Announcement of Opportunity



Search **Access to Space for All**



UNITED NATIONS
Office for Outer Space Affairs

About Us | Our Work | Space4SDGs | Information for... | Events | Space Object Register | Documents | COPUOS 2023

Our Work > Access to Space for All



ACCESS TO SPACE FOR ALL
A joint initiative to offer access to space research facilities, infrastructure and information, and to promote international cooperation in the peaceful uses of outer space.

Our Work

- Secretariat of COPUOS
- Programme on Space Applications
- UN-SPIDER
- International Committee on GNSS
- UN-Space

Benefits of Space

Access to Space for All

- For Member States
- Partnerships
- Opportunities
- Awardees
- Acknowledgement
- Space Law for New Space Actors
- Space for Persons with Disabilities
- Space4Youth

- For Member States
- Partnerships
- Awardees
- Contribution to the SDGs
- Brochure
- Hypergravity/Microgravity Track**
- Satellite Development Track
- Space Exploration Track
- Workshops and Expert Meetings

Access to Space for All Latest Information

- EVENT** Access to Space for All will hold a hybrid side event at the 66th session of COPUOS on 31 May 2023, [read more](#) (26 May 2023)
- EVENT** KiboCUBE will hold a hybrid side event at the 66th session of COPUOS on 2 June 2023, [read more](#) (26 May 2023)
- EVENT** 1st Access to Space for All Expert Meeting has been held on 15-17 May 2023 online, [read more](#) (17 May 2023)
- NEWS** UNOOSA and ESA announced the 2nd round HyperGES awardees on 8 May, [watch here](#) (8 May 2023)

Hypergravity/Microgravity Track

HYPERGRAVITY AND MICROGRAVITY

- Building capacity for conducting experiments in orbit

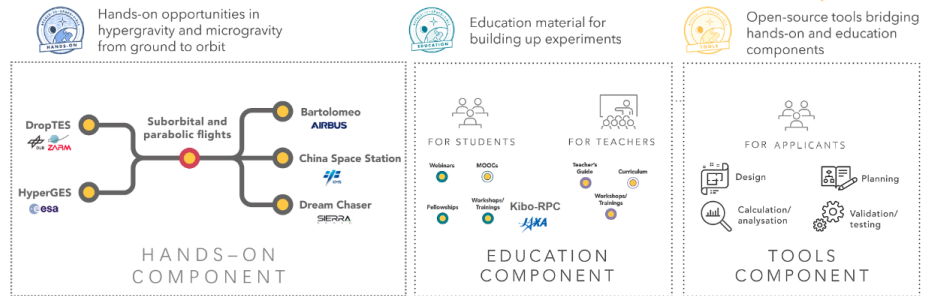

The Hypergravity/Microgravity Track is designed with the end goal of developing the capacity of running various space experiments onboard the orbital vehicles or space stations.

Hands-on Component

- DropTES**
- HyperGES
- Bartolomeo
- China Space Station
- Dream Chaser

Education Component

- Kibo-RPC
- Hyper/Microgravity Series of Webinars
- Teacher's Guide
- Common Webinars
- DropTES Webinars
- HyperGES Webinars
- Bartolomeo Webinars

Tools Component

- Tools component



Access to Space for All

DropTES - Announcement of Opportunity



Fellowship Programme for "Drop Tower Experiment Series" (DropTES)



News

- NEW!** Access to Space for All will hold a hybrid side event at the 66th session of COPUOS on 31 May 2023. [read more >](#)
- UNOOSA and ZARM announced the 8th round awardee on 10 March 2023, read the [press release](#).
- Read the [Access to Space for All initiative for Sustainability: Interview Series Article #4 "DropTES: The Opportunity to Expand Your Horizon and its contribution to the SDGs"](#)
- Read the [Access to Space for All initiative for Sustainability: Interview Series Article #3 "DropTES: The Stepping Stone into Space Activities and its contribution to the SDGs"](#)

- Our Work
- Secretariat of COPUOS
- Programme on Space Applications
- UN-SPIDER
- International Committee on GNSS
- UN-Space
- Space Law
- Benefits of Space
- Access to Space for All
 - For Member States
 - Partnerships
 - Opportunities
 - Hypergravity/Microgravity Track
 - Satellite Development Track
 - Space Exploration Track
 - Awardees
 - Acknowledgement
- Space Law for New Space Actors
- Space for Persons with Disabilities

ROUNDS



The Drop Tower Experiment Series is a fellowship programme of the United Nations Office for Outer Space Affairs (UNOOSA) in collaboration with the Center of Applied Space Technology and Microgravity (ZARM) and the German Aerospace Center (DLR). We started this programme in 2014.

Visiting previous rounds provides you with a better understanding of this programme, start your excellent application from here!

[read more >](#)

AWARDEES



- 1st Round: German Jordanian University
- 2nd Round: Universidad Católica Boliviana "San Pablo"
- 3rd Round: Instituto Tecnológico de Costa Rica & Universidad de Costa Rica
- 4th Round: Warsaw University of Technology
- 5th Round: University of Bucharest & Politehnica University of Bucharest
- 6th Round: Politecnico de Milano
- 7th Round: Universidad Católica Boliviana "San Pablo"
- 8th Round: Universidad de Antioquia

[read more >](#)

PARTNERS



This opportunity is in collaboration with the German Aerospace Center (DLR) Space Administration, and the Center of Applied Space Technology and Microgravity (ZARM), a scientific institute at the University of Bremen in Germany with a focus on research under space conditions and questions related to space technology. With a height of 146 meters, the Bremen Drop Tower is the predominant laboratory at ZARM and also the only drop tower of its class in Europe.

[read more >](#)

- Space4Water
- Space4Women
- World Space Forum
- Worldwide Space Agency
- Capacity Building Activities

Latest

2023年5月28日
NEWS HyperGES Round 2

Links

- VIC Online
- UNIS Vienna

Contact us

United Nations Office for Outer Space Affairs
United Nations Office at Vienna



Access to Space for All

DropTES - Announcement of Opportunity



UNITED NATIONS
Office for Outer Space Affairs



UNITED NATIONS
Office for Outer Space Affairs



Search

[About Us](#) [Our Work](#) [Space4SDGs](#) [Information for...](#) [Events](#) [Space Object Register](#) [Documents](#) [COPUOS 2023](#)

[Our Work](#) > [Access to Space for All](#) > [Opportunities](#) > [Hypergravity/Microgravity Track](#)

DropTES Rounds

9th Round Schedule

Opened: 31 May 2023, read the [press release](#)

Announcement of Opportunity Webinar: Wednesday 21 June 2023: register [here](#).

Deadline for submitting the Expression of Interest form: **31 August 2023 23:59** Central European Summer Time (CEST, UTC+2)

Deadline for submitting the Application Form: **26 November 2023 23:59** Central European Time (CET, UTC+1)

9th Round Documentation

ANNOUNCEMENT OF OPPORTUNITY DOCUMENTS

- [Expression of Interest form \(.docx\)](#)
- [Announcement of Opportunity \(.pdf\)](#)
- [Application Form \(.docx\)](#)
- [Evaluation Table \(.xlsx\)](#)

REFERENCE MATERIALS

- [Bremen Drop Tower Payload User's Guide Version 1.2 \(ZARM website\)](#)
- [General Information of the Bremen Drop Tower \(ZARM website\)](#)
- [DropTES Webinars \(UNOOSA website\)](#)
- [Webinar Series on Conducting R&D in Hypergravity/Microgravity \(UNOOSA website\)](#)

Our Work

[Secretariat of COPUOS](#)

[Programme on Space Applications](#)

[UN-SPIDER](#)

[International Committee on GNSS](#)

[UN-Space](#)

[Space Law](#)

[Benefits of Space](#)

[Access to Space for All](#)

[For Member States](#)

[Partnerships](#)

[Opportunities](#)

[Hypergravity/Microgravity Track](#)

[Satellite Development Track](#)

[Space Exploration Track](#)

[Awardees](#)

[Acknowledgement](#)

[Space Law for New Space Actors](#)

[Space for Persons with](#)

[Disabilities](#)



Access to Space for All

DropTES - Announcement of Opportunity



Announcement of Opportunity!
31 May 2023

 Announcement of Opportunity Webinar: Ask your question!
21 June 2023

 Submit your Expression of Interest to book a technical consultation!
31 August 2023

 UNOOSA will schedule a technical consultation with your team!
September 2023

 Submit the completed Application Form!
26 November 2023



2 0 2 3

May June July August September October November



 Announcement of Selection Results
End of Jan 2024

 Preparation Phase
Feb - Q4 2024

 Critical Design Review
July 2024

 Outreach & Publication Phase

 Experiment Phase
Q4 2024

 Reporting Phase
31 Jan 2025

2 0 2 4

2025

January February March April May June July August September October November December January



Access to Space for All

DropTES - Announcement of Opportunity

12. Eligibility Criteria

This Opportunity is open to entities located in developing economies and economies in transition that are Member States of the United Nations. Government organisations, research institutes, universities, other public and non-for-profit organisations are eligible to apply for this Opportunity.

To assess eligibility, UNOOSA will use the country classification list of developing economies and economies in transition indicated in the joint report, World Economic and Situation Prospects published by the United Nations Department of Economic and Social Affairs and other related organisations: <https://desapublications.un.org/file/1098/download>

Entities located in countries that have not conducted research under space conditions at the time of the opening of this application are particularly encouraged to apply. Priority will be given to teams that have not previously participated in an experiment series at the Bremen Drop Tower and/or GraviTower Bremen Pro and/or research projects that have never been conducted at the Bremen Drop Tower and/or GraviTower Bremen Pro.

Each team should consist of a team leader and up to four team members. The team leader must belong to the same entity as at least one of the team members. All team members must be from entities that are eligible to participate and all participating entities must submit the Letter of Endorsement from their entities' directors. The team leader shall be responsible for all matters related to the application and bear responsibility for the execution of the experiment. The teams could consist of several entities, with one leading entity that takes responsibility.

The teams may be larger, however, the financial support listed in Section 14 is applicable to one team leader and four team members only. The final number of team members who will participate in the experiment on-site at the ZARM facility depends on the requirements of the experiment and is subject to approval by the Selection Board of the DropTES Fellowship Programme. The Board reserves the right to limit the team size if it deems necessary.

Changes to the composition of the team are NOT allowed once the application has been submitted. If, for exceptional reasons, changes are absolutely necessary, they will be subject to the approval of the Selection Board.

Teams are allowed and encouraged to partner with external entities that can support their development, even if those entities are not eligible themselves. These partnerships should be clearly written as "External Support" in the Application Form and external partners shall not be included in the team.

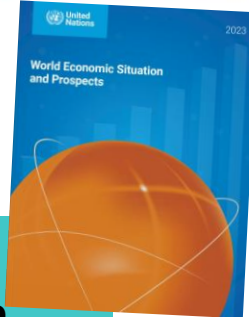

Entities located in **developing economies and economies in transition**



Entities = **Government organisations, research institutes, universities, other public and non-for-profit organisations**



Team = **1 Team Leader + 4 Team Members**



Partnerships = Include in team if the partner is also an eligible entity, if not put them under "External Support"



Access to Space for All

DropTES - Announcement of Opportunity



UNITED NATIONS
Office for Outer Space Affairs

13. Selection Criteria

The Selection Board will consist of team members from UNOOSA, ZARM, and DLR - German Space Agency. The Board will assess all applications against the following criteria:

- | | | |
|-------|----------------------------------------------------------------------------------------------------------------------------------------------------------------------------------------------------------------------------------------------------------------------------------------------------------------------------------------------------------------------------------------------------------------------------------|-----|
| (i) | Experiment Content:
The educational, scientific, and/or technological value of the proposed experiment and the relevance of the utilisation of the ZARM facility, details of the experiments as well as the data acquisition and data analysis plan in the proposed experiment. | 25% |
| (ii) | Team Composition:
The skills set, organization, and composition of the team. The team shall demonstrate competence in scientific and technological research or in education as well as in project management. The team composition of proposals with the same score will be compared and the proposal with a larger number of women will be ranked higher. | 30% |
| (iii) | Planning: <ul style="list-style-type: none">• General feasibility of the proposed experimental design and procedure, including data acquisition and data analysis plan, the work breakdown structure, overall schedule credibility, and risk analysis.• Budget plan to support the development, preparation, transportation, and shipping of the experiment, as well as the availability of funds. | 25% |
| (iv) | Outreach:
The communication and dissemination plan for outreach activities to promote capacity-building and STEM education, clearly linking the project with the Sustainable Development Goals of the United Nations 2030 Agenda on Sustainable Development.
For more information about the SDGs: https://sdgs.un.org/ | 20% |



Access to Space for All

DropTES - Announcement of Opportunity



UNITED NATIONS
Office for Outer Space Affairs

14. Financial and Technical Support

The awardee will be offered the most economical round-trip air tickets for up to five persons between the participants' international airport of departure and Bremen. Participants are responsible for any en-route expenses or flight changes.

UNOOSA, ZARM, and DLR will neither bear the expenses related to the preparation, transportation, shipping, nor the insurance of the experiment or of the team members. The awardee must cover these costs.

The use of the Bremen Drop Tower or the GraviTower Bremen Pro is sponsored by DLR - German Space Agency. The technical support provided by ZARM is included and therefore free of charge.

ZARM will provide the team access to its cost-free on-site apartment at the drop tower facility. The apartment has two separate rooms with two beds in each room, a common bathroom, and a common kitchen. The ZARM apartment can accommodate up to four people.

UNOOSA will cover the accommodation expenses of the team leader at a nearby hotel, within walking distance from ZARM.

UNOOSA



Round-trip tickets for 1 Team Leader and 4 Team Members



Accommodation for the Team Leader

ZARM



Accommodation for the 4 Team Members



Technical support onsite

DLR



Costs related to the use of the facility

Awardee Team



All costs related to the preparation, development, transportation, shipping, insurance, outreach activities etc.



Access to Space for All

DropTES - Announcement of Opportunity



15. Publications

The awardee is requested to inform UNOOSA, ZARM and DLR of any publications related to this experiment including PhD, Master thesis, publications in journals, and conference or workshop proceedings and presentations. The awardee is requested to include the following sentence in their peer-reviewed publications, contributions to congresses, and other forms of written dissemination:

The authors would like to thank the United Nations Office for Outer Space Affairs, the Center of Applied Space Technology and Microgravity (ZARM), and the German Aerospace Center (DLR) - German Space Agency for the Access to Space for All initiative: DropTES opportunity for their support in enabling the utilization of ZARM's Bremen Drop Tower and/or GraviTower Bremen Pro facility.

💡 This is for the entire "Outreach and Publication" Phase



Access to Space for All

DropTES - Expression of Interest Form



Who should fill in this Expression of Interest?

- **Eligible** teams
- Teams that have an experiment idea and would like to obtain guidance on how to materialize it.

What should you do in the form?

- Describe briefly your intended experiment;
- Use clear language or graphs/tables;
- Do not exceed one page.

Tips

- It is not Mandatory.
- Read documents first.
- Submit in time!



Access to Space for All

DropTES -Application Form



Chapter 1: Basic Information

1.1 Project Title **[Mandatory]**

1.2 Executive Summary: (no more than 150 words) **[Mandatory]**

Please summarize sections 4, 6, 7, and 8.

4. experiment objectives and expected outcomes

6. Planning

7. Budget

8. Communication and dissemination plan

1.3 Certificate **[Mandatory]**

1.4 Head of Applying Organization Information **[Mandatory]**

- 💡 Summarize
 - why you chose to perform this experiment
 - what are expected outcomes
 - why your experiment is unique
 - your plan

- 💡 Besides the Certificate, a Letter of Endorsement is also required from each applying entity.



Access to Space for All

DropTES -Application Form



Chapter 2: Team Composition

2.1 Team Leader [**Mandatory**]

The team leader must belong to the same entity as at least one of the team members. The team leader shall be responsible for all matters related to the application and bear responsibility for the execution of the experiment.

2.2 Team Member(s) [**Mandatory**]

All team members must be from entities that are **Eligible To Participate** and all participating entities must submit the Letter of Endorsement from their entities' directors.

2.3 Description of Cooperation/External Support [**Optional**]

If it is a joint proposal from several entities, please describe the role and responsibilities of each entity. If you receive support from external organizations or individuals, please list them here.



Access to Space for All

DropTES -Application Form



Chapter 3: Technical Abstract

3 Proposal Technical Abstract **[Mandatory]**

Please describe the proposed experiment, including the **science/technology rationale**, the **relevance of utilizing the Bremen Drop Tower/GraviTower Bremen Pro facility**, and the **expected results**. The abstract should concisely describe the above in a maximum of **300 words**.

- 💡 Summarize
 - why you chose to perform this experiment
 - how the microgravity environment helps your experiment
 - what are expected outcomes



Access to Space for All

DropTES -Application Form

Chapter 4: Experiment Objectives and Expected Outcomes

4.1 Experiment Rationale **[Mandatory]**

The scientific and technical or educational value of the proposed experiment; the theoretical basis; the hypothesis on the effect of microgravity; evidence or data from (international, peer-reviewed) publications and your observations to support your hypothesis.

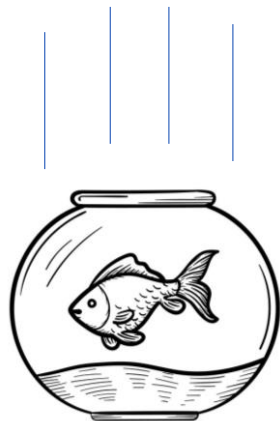

Example:

Study of adrenaline production in fish induced by weightlessness

- *The regulation mechanism of animal stress response in a microgravity environment may provide a research basis for human health;*
- *Adrenaline production in animals increases due to stress in response to environmental changes;*
- *It is assumed that microgravity causes rapid adrenaline secretion;*

- 💡 Clearly state:
- your experimental rationale,
 - how the experiment is going to support the research
 - why are you thinking the hypothesis is reasonable.



Access to Space for All

DropTES -Application Form

4.2 Experiment Objectives [**Mandatory**]

Please list the objectives of the proposed experiment, please use SMART criteria (Specific, Measurable, Achievable, Realistic, Time-bounded) to define the objectives. Objectives shall be numbered as Obj-XXX (e.g. Obj-001, Obj-002...)

- 💡 Clearly state:
Experimental objectives
- **S**pecific
 - **M**easurable
 - **A**chievable
 - **R**ealistic
 - **T**ime-bounded

Example:

Experiment Objectives:

Obj-001: Measure the adrenaline levels at T0 and T0+1min to determine the adrenaline production in response to stress in fish under weightless conditions;

Obj-002: Measure the adrenaline at T0+1min, T0+5min, and T0+10min to determine the recovery time after being subjected to stress under weightless conditions;

...

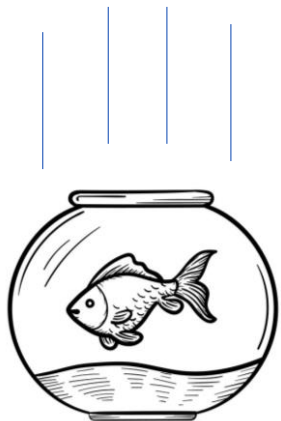



Access to Space for All

DropTES -Application Form

4.3 Foreseen Outcomes **[Mandatory]**

Please insert a description of the specific outcomes of the experiment with a maximum of **150 words**.

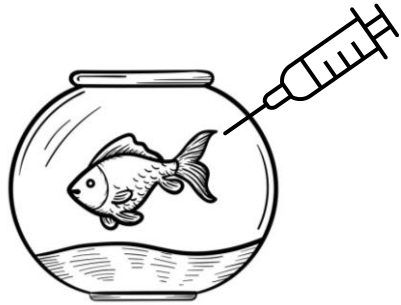

Example:

*Foreseen Outcomes:
The adrenaline level in the fish was significantly elevated one minute after the experiment and returned to a normal level after 10 minutes.*

4.4 Novelty, Uniqueness, and Possible Evolutions **[Mandatory]**

Describe why the proposed experiment is new and unique, including how it differs from similar experiments conducted using the microgravity environment (if applicable), in a **maximum of 150 words**.

- 💡 Clearly state:
 - the possible effects of microgravity on the experiment;
 - the expected results
 - directly observed;
 - through data and/or sample analysis after the experiment.

- 💡 Why is your experiment special?



Access to Space for All

DropTES -Application Form

Chapter 5: Experiment Specifications and Description

5.1 Main Specifications **[Mandatory]**

You can use graphs and tables for some items such as the below

Table 5.1. Experiment main specifications

Parameter	Values	Units
Mass	20	kg
Maximum Dimensions	300 x 300 x 300	mm

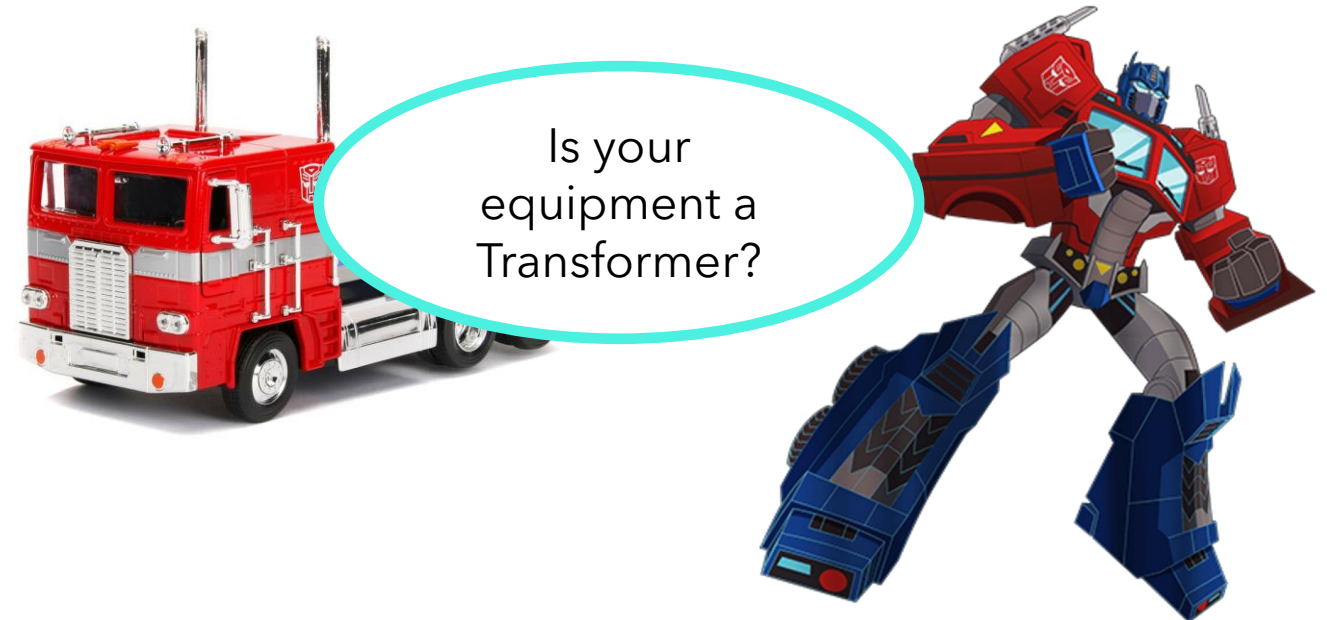

💡 What kind of equipment you are going to bring into the capsule?
Does it fit?
READ the user manual



Access to Space for All

DropTES -Application Form

5.2 Expected Experiment Environment & Conditions [**Mandatory**]

Describe the experimental environment or conditions required for the proposed experiment, such as the **desired gravity condition**, and the duration that the equipment will be exposed to that gravity environment. Please read ZARM's Bremen Drop Tower - Payload User's Guide at its latest version in detail to see the parameters available for the Bremen Drop Tower/GraviTower Bremen Pro.

<https://www.zarm.uni-bremen.de/en/drop-tower/experiment-support.html>

Clarify:

- which drop mode you want to use;
- which type of capsule you want to use;
- any other specific conditions.

READ the user manual

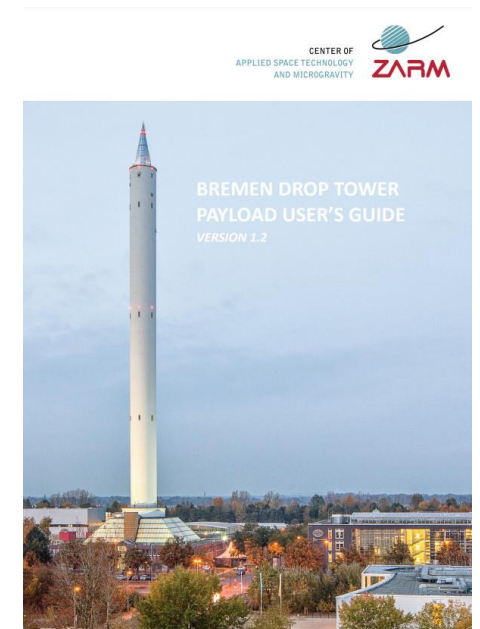



Access to Space for All

DropTES -Application Form

5.3 Design Requirements **[Mandatory]**

Please describe the design requirements of the experimental setup, including samples, control equipment, data acquisition equipment, etc. Note that the requirements have to be verifiable and compatible with what is stated in ZARM's Bremen Drop Tower - Payload User's Guide at its latest version. Requirements shall be numbered as Req-XXX (e.g. Req-001, Req-002...).

Example:

Req-001: the height of the equipment casing shall measure 27cm;

Req-002: the framework of the equipment shall bear a deceleration force up to a peak value of 50g;

Req-003: Power supply of the equipment: 24V DC 0.5A

💡 List the design requirements for your equipment, then we will know whether your experiment is feasible.

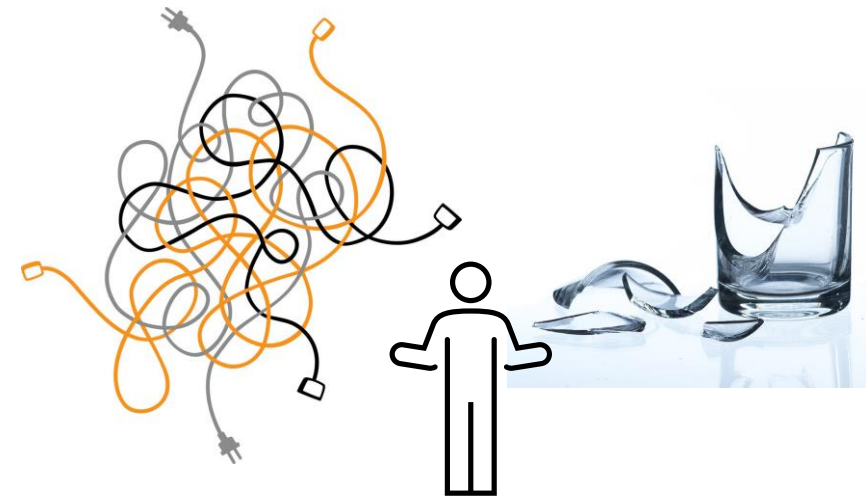



Access to Space for All

DropTES -Application Form

5.4 Experiment Design Definition **[Mandatory]**

Please use block diagrams and descriptive text to explain all equipment for the proposed experiments. If there is a control group as part of the experiment, please describe it together.

 Use block diagrams to help us and yourself understand the experiment design.

Example:

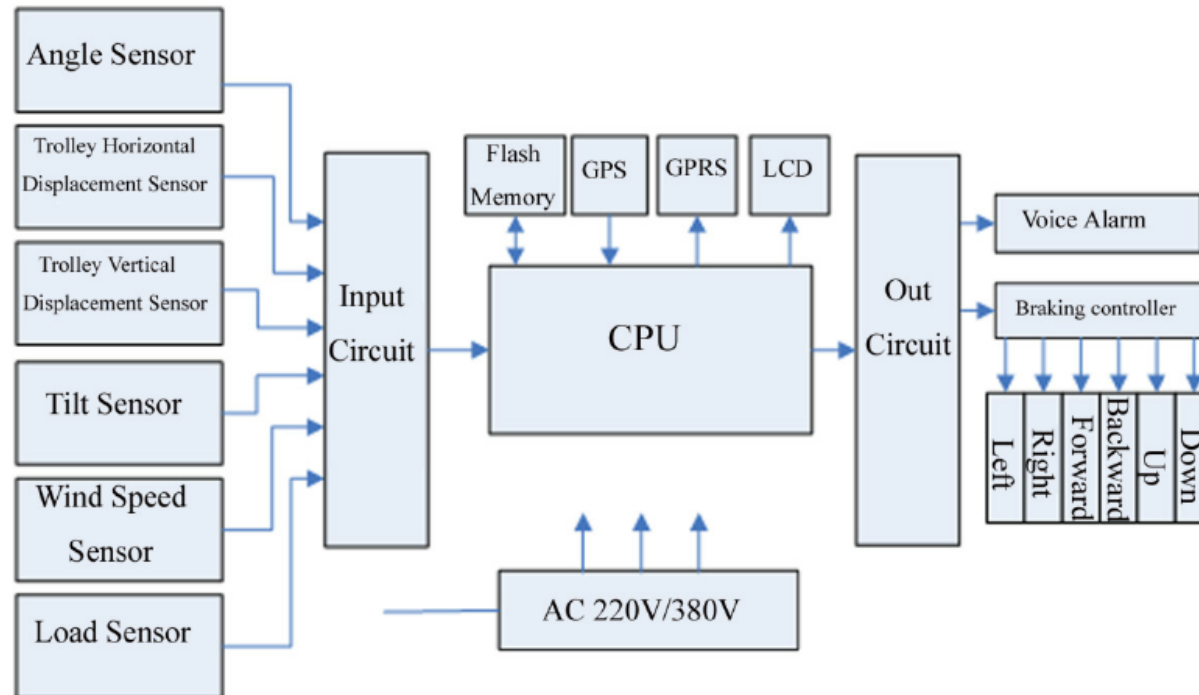



Access to Space for All

DropTES -Application Form

5.5 Experiment Materials **[Optional]**

Please list the materials to be used in the experiment as comprehensively as possible, especially if the proposed experiment is for biological samples, please list the samples to be used.

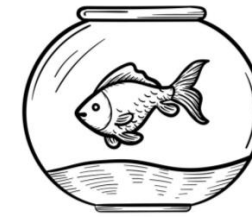

Example:

5.6 Experiment Procedure **[Mandatory]**

Please use a block diagram or flowchart and descriptive text to explain the method and procedure of the proposed experiment.

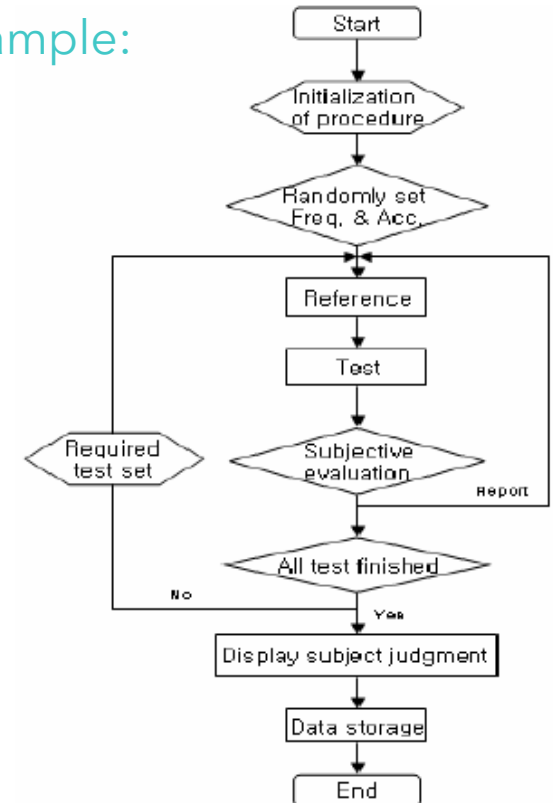



Access to Space for All

DropTES -Application Form

5.7 Data Acquisition System **[Mandatory]**

Please describe the method of acquiring data in the proposed experiment and the equipment used to access the data. Please clarify whether the team has access to all the equipment. And if not, whether the team intends to realize the data acquisition through external cooperation and procurement.

💡 Remember the Experiment Objectives? We asked for the measurable objectives, here we want to see how will you measure them.

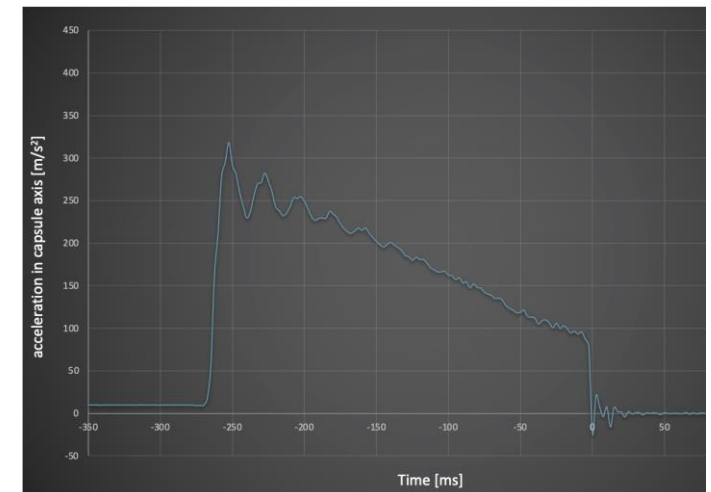



Access to Space for All

DropTES -Application Form

5.8 Data Analysis Scheme **[Mandatory]**

Please describe the method of data analysis and the equipment required. Please clarify whether the team has access to all the equipment. And if not, whether the team intends to realize the data analysis through external cooperation and procurement.

- 💡 Clearly state;
 - how will you analyse the data?
 - Do you have all the equipment you need to analyse?

5.9 Verification Criteria **[Mandatory]**

Describe how the results of the experiment will verify the objectives of Paragraph 4.2, with the related verification method, and how to determine whether the experiment is successful.

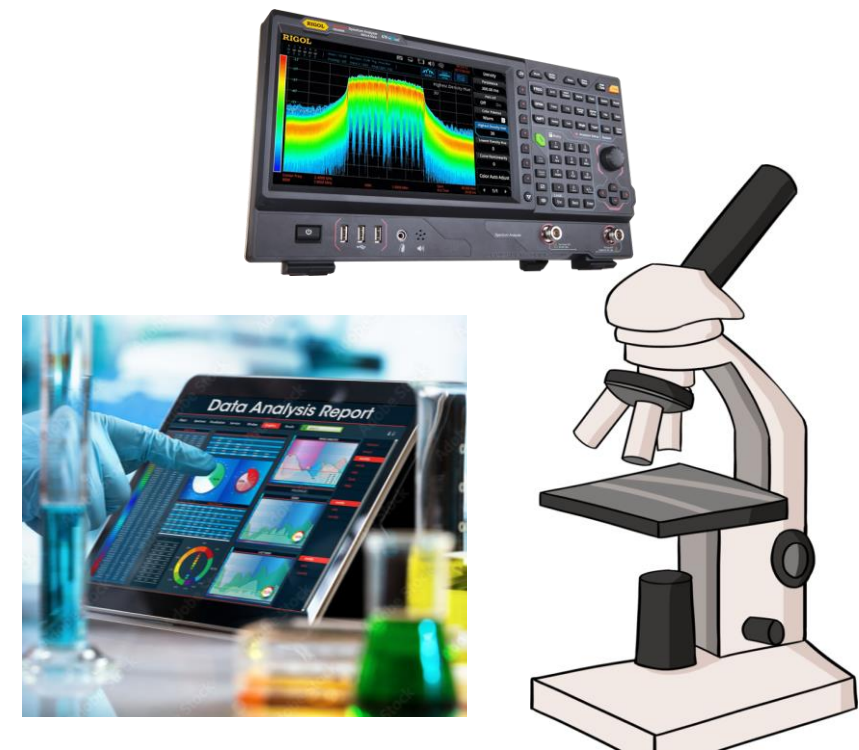



Access to Space for All

DropTES -Application Form

5.10 Current Status of the Proposed Experiment **[Optional]**

Please describe the work your team has already done for the proposed experiment, including theoretical findings, experimental equipment development, and preparation.

- 💡 If you have already started work on the experiment;
- what have you already done?
 - what is the current status?

Either you already have a laboratory and have done some research



Or you will start with a good idea and a team of ambitious people





Access to Space for All

DropTES -Application Form

Chapter 6: Planning

6.1 Development Schedule **[Mandatory]**

Please provide a tentative schedule to develop and perform the proposed experiment. The development schedule shall include all phases starting from the kick-off meeting to the submission of the final report and clarify the critical path. A Gantt chart and a description shall be included.

💡 The critical path is the longest path (in time) from Start to Finish; it indicates the minimum time necessary to complete the entire project.

Example:

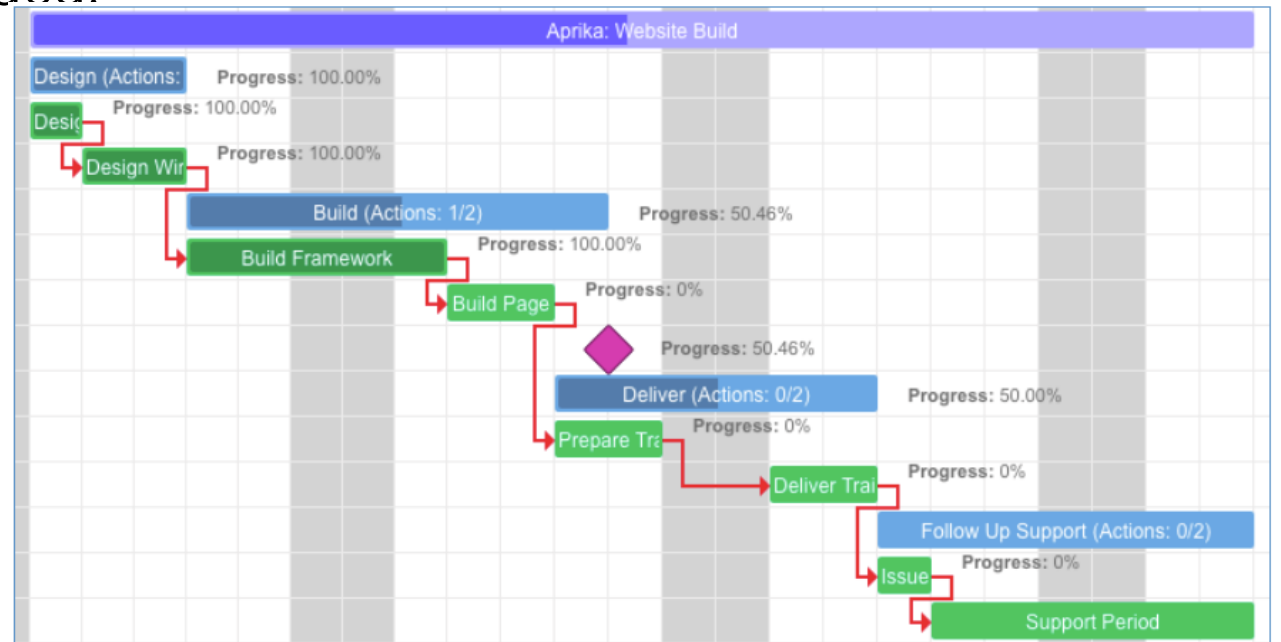
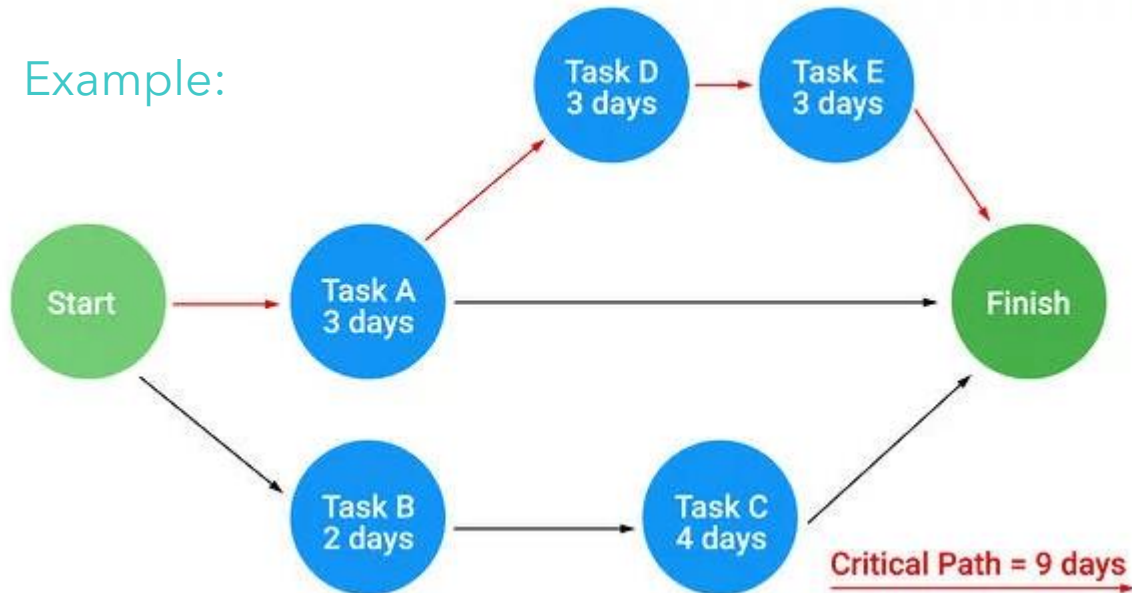



Access to Space for All

DropTES -Application Form

6.2 On-site Integration and Experiment Schedule **[Mandatory]**

Please provide a tentative schedule for all activities that take place in Bremen within a maximum of two weeks.

Example:

	Mon	Tue	Wed	Thu	Fri	Sat	Sun	Mon	Tue	Wed	Thu	Fri	Sat	Sun	
Week #	Week 1							Week 2							
Task 1	[Orange]														
Task 2		[Green]													
Task 3						[Red]									
Task 4							[Yellow]								
Task 5					[Dark Blue]										
Task 6												[Light Blue]			

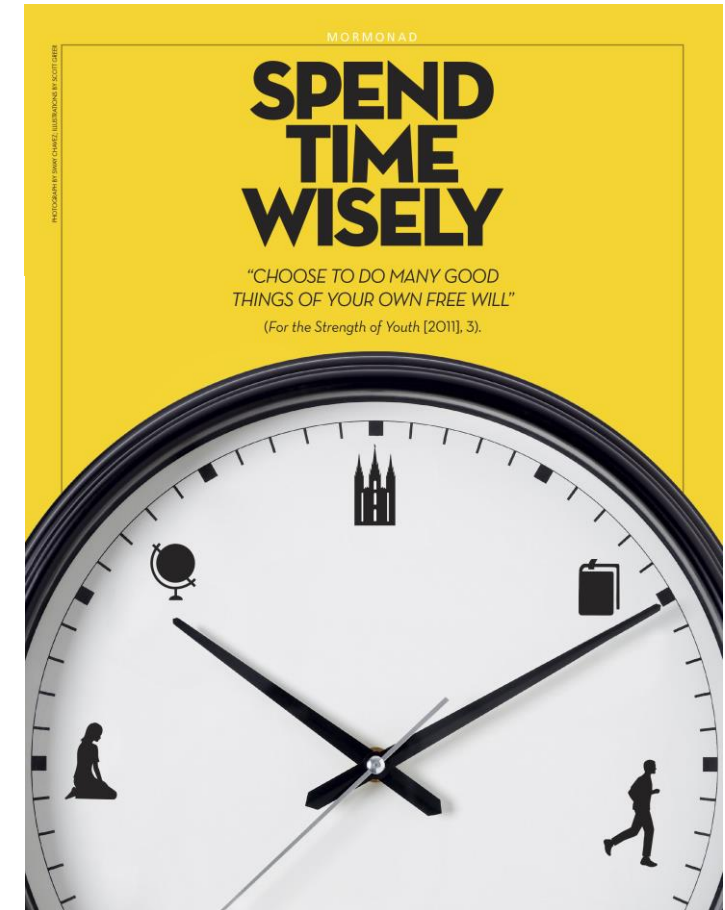



Access to Space for All

DropTES -Application Form



6.3 Work Breakdown Structure **[Mandatory]**

Please include the Work Breakdown Structure for the design, development, testing, and all other activities required until the experiment has been completed, including the outreach activities. In case of partnerships, please indicate the share of the work among the partners/team members for the different work packages.

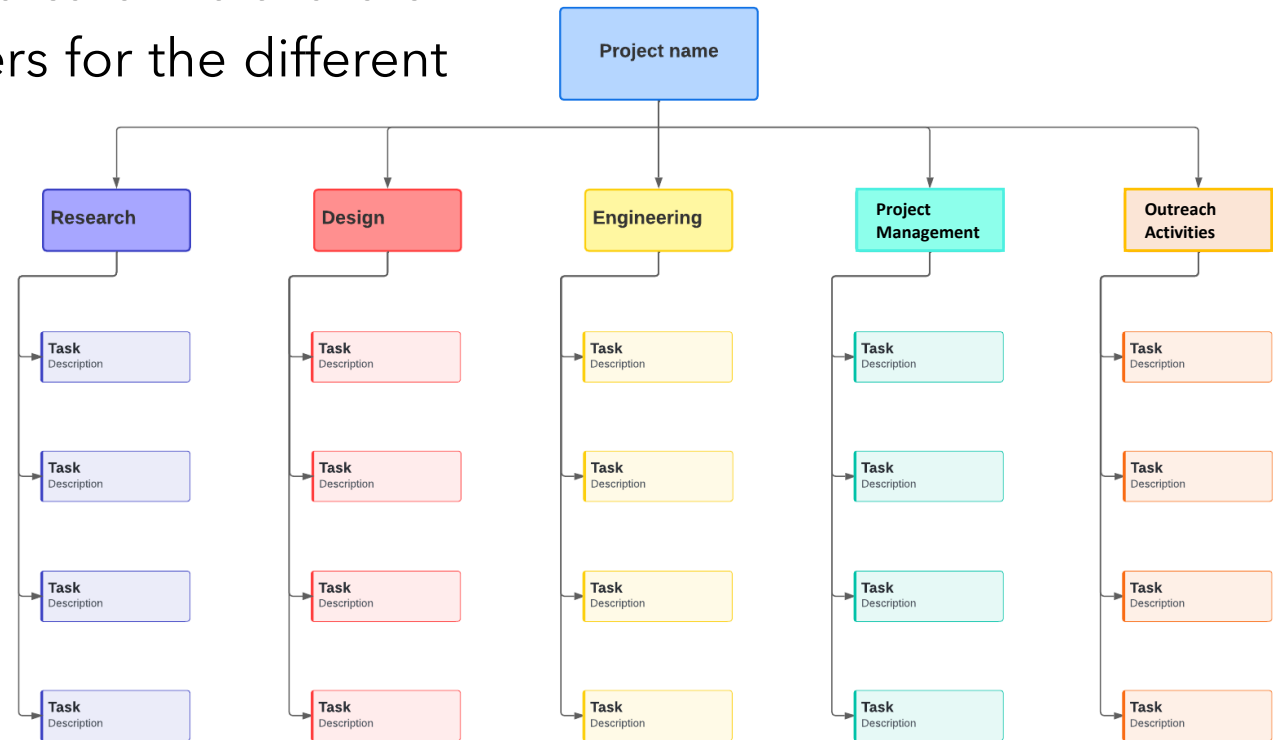



Access to Space for All

DropTES -Application Form

6.4 International Transportation Plan **[Mandatory]**

Please provide information concerning the transportation of the equipment, and customs arrangements (if applicable).



💡 Sending experiments and samples are more complicated than you think...

Check customs for both your country and Germany

- What documents do you need to prepare?
- How long it will take?

Plan the shipment in advance!



https://www.zoll.de/EN/Home/home_node.html



Access to Space for All

DropTES -Application Form

Chapter 7: Budget

7.1 Budget Plan [Mandatory]

Please provide information on the cost, including the price of the parts, personnel costs, facilities costs, operation costs, travel expenses, shipment of the equipment, and dissemination activities.



Example:

For Product Development Cycle 2.0	Version 1.0	Version 2.0	(+/-)	%Change	Comments/ Assumptions
Personnel Expenses					
Full-time Salaries	\$564,000	\$683,000	\$78,000	12%	Text Here
Temporary Workers	\$47,000	\$58,000	\$15,000	25%	Text Here
Consultants	\$1,200	\$0	-\$1,300	-110%	Text Here
Outsourcing Contracts	\$22,000	\$16,900	-\$6,100	-24%	Text Here
Training/Seminars	\$1,400	\$2,000	\$1,400	120%	Text Here
Travel (E.G. Plan Tickets)	\$2,000	\$5,000	\$1,400	35%	Text Here
Accommodation (E.G. Hotels)	\$2,000	\$4,000	\$1,000	28%	Text Here
Total Person Expenses	\$749,500	\$771,900	\$92,400	16%	
Marketing Expenses					
Online Advertising	\$18,000	\$24,000	\$8,000	35%	Text Here
Print Advertising	\$35,000	\$48,000	\$5,000	27%	Text Here
Events Tradeshow Sponsorships	\$32,000	\$26,000	-\$20,000	-23%	Text Here
Marketing Collateral	\$2,000	\$3,500	\$600	17%	Text Here
Prospect List	\$8,000	\$12,900	\$7,600	122%	Text Here
Other	\$1,000	\$400	\$200	170%	Text Here
Total Marketing Expenses	\$100,200	\$113,700	\$13,500	13%	
Production Expenses					
Raw Materials	\$748,000	\$1,856,789	\$684,789	95%	Text Here
Equipment	\$275,000	\$200,800	-\$144,200	53%	Text Here
Training	\$28,000	\$275,700	\$11,700	48%	Text Here
Total Production Expenses	\$1,028,000	\$1,523,289	\$586,500	65%	
Software Expenses					
Design Application	\$26,500	\$37,000	\$6,800	27%	Text Here
Production Management Application	\$21,000	\$24,000	\$5,500	29%	Text Here
Other Applications	\$2,600	\$2,400	-\$300	-18%	Text Here
Total Production Expenses	\$62,400	\$66,500	\$12,100	25%	
Total Expenses	\$1,929,100	\$2,702,389	\$873,289	28%	Text Here

 **Financial Support**

- UNOOSA and ZARM will pay for international air tickets and accommodations for up to 5 people.
- Applicants shall cover all costs related to the preparation, development, transportation, shipping, insurance, outreach activities, and extra personnel if applicable.



Access to Space for All

DropTES -Application Form

7.2 Budget Source and Expected Budget Source **[Mandatory]**

Please provide information on the secured budget (committed budget), specifying the funding source, and information on the envisaged funding sources of any remaining budget.

Example:

BUDGET

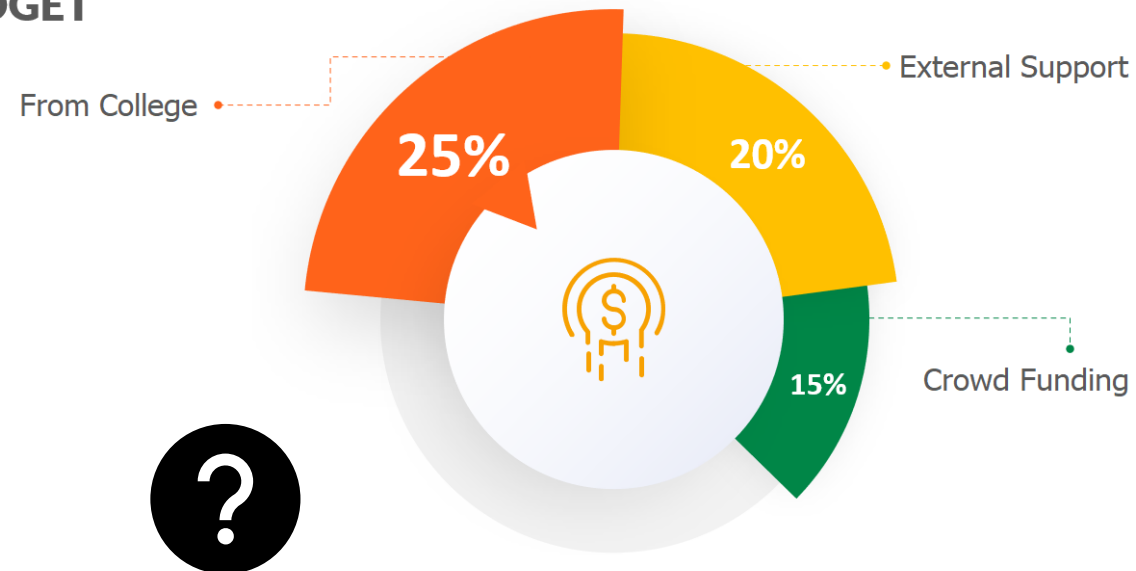



Access to Space for All

DropTES -Application Form



Chapter 8: Communications and Dissemination Plan

8.1 Communications and Dissemination Plan **[Mandatory]**

Provide the plan (e.g. scope, schedule, resources, means) that will be used to promote the experiment and its results, as well as communication towards the general public. Specific activities shall be organised within the applicant country(ies).



Session 4: Effective Outreach Presentations on successful examples and discussion on how to conduct effective outreach activities
Presentations and Videos are available!

- 💡 Summarize
 - What kind of outreach activity you will do to enhance the outcomes of your project?
 - Who is your target audience?
 - What is the timeframe for the different outreach activities you have planned
 - What resources/platforms will you use?



<https://www.unoosa.org/oosa/en/ourwork/psa/schedule/2023/accspace4all-expert-meeting.html>



Access to Space for All

DropTES -Application Form



8.2 Relevance to the Sustainable Development Goals **[Mandatory]**

Please describe what Sustainable Development Goals (SDGs) are supported by the experiment and its associated results. Please indicate how the participation in the AO and its related activities contribute to progress on one or several Sustainable Development Goals in your country(ies) and the expected social impact. Note that DropTES contributes to SDG 4 "Quality Education"; SDG 8 "Decent Work and Economic Growth" and SDG 9 "Industry, Innovation and Infrastructure".

Goals

3
Ensure healthy lives and promote well-being for all at all ages

3 GOOD HEALTH AND WELL-BEING

Target **3.1**
By 2030, reduce the global maternal mortality ratio to less than 70 per 100,000 live births

Indicators

3.1.1
Maternal mortality ratio

3.1.2
Proportion of births attended by skilled health personnel

💡 All of the 17 Goals each have

- Targets
- Indicators

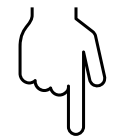

<https://sdgs.un.org/>



Access to Space for All

DropTES -Application Form

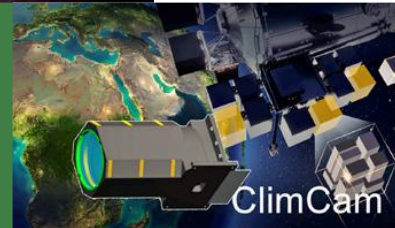
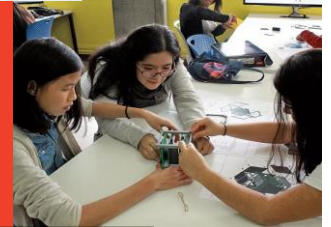
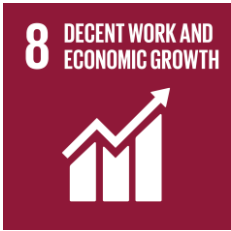

Access to Space for All initiative for Sustainability: Interview Series Article

[1# How Bartolomeo x ClimCam Project Contributes to the SDGs](#)

[2# How Education Through PNST Contributes to the SDGs](#)

[3# DropTES: The Stepping Stone into Space Activities and its Contribution to the SDGs](#)

[4# DropTES: The Opportunity to Expand Your Horizon and its contribution to the SDGs](#)

[5# PHI: The Platform to Realize Your Dreams](#)

For more Access to Space for All Awardees' stories, visit:



<https://www.unoosa.org/oosa/en/ourwork/access2space4all/Awardees.html>





Access to Space for All

DropTES -Application Form

Chapter 9: Risk Analysis

 Brainstorm to find out every risk that may occur and affect your experiment.



9 Risk Analysis **[Mandatory]**

Please use a risk matrix to describe the risks that you might face. These should include technical risks (e.g. mechanical, chemical, thermal, biological radiation, etc.), planning risks and budget risks. Please assess their likelihood of occurrence 1 (not likely) to 3 (very likely), and their impact (1 (minor impact) to 3 (catastrophic) and mitigation actions for each of them.

Example:

- *Your laboratory didn't finish the equipment in time.*
- *Part of your budget has been reallocated to another project in the middle of your project.*
- *You lost your luggage at the airport.*

3x3 RISK MATRIX

		SEVERITY →		
		1	2	3
LIKELIHOOD ↓	1	LOW -1-	LOW -2-	MEDIUM -3-
	2	LOW -2-	MEDIUM -4-	HIGH -6-
	3	MEDIUM -3-	HIGH -6-	HIGH -9-



UNITED NATIONS
Office for Outer Space Affairs



Question & Answer Time

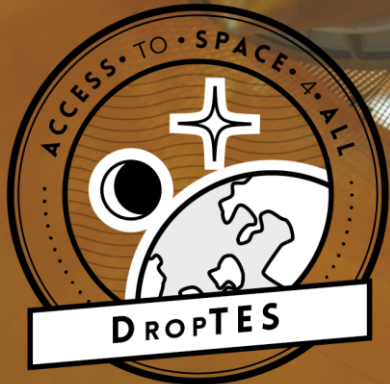



Access to Space for All Opportunities



Open for Applications

HYPERGRAVITY/
MICROGRAVITY



Suborbital and parabolic flights

Bartolomeo AIRBUS

China Space Station CMS

Dream Chaser SIERRA SPACE

Webinar on 26 June!

SATELLITE DEVELOPMENT

canSATs

PHI
مركز محمد بن راشد
للعلوم والفضاء
Mohammed Bin Rashid Space Centre

KiboCUBE JAXA

Vega-C AVIO

Webinar on 22 June!

Kibo-RPC JAXA

PNST MEXT
MINISTRY OF EDUCATION, CULTURE, SPORTS, SCIENCE AND TECHNOLOGY-JAPAN
Kyutech
Kyushu Institute of Technology

KiboCUBE Academy JAXA

UNISEC
University Space Engineering Consortium

SPACE EXPLORATION

ISONscope

Ground Analogues

Beyond GEO



Any questions?

Contact us

 [**unoosa-access-to-space@un.org**](mailto:unoosa-access-to-space@un.org)

**Help us help
#AccSpace4All**



**For more stats and information,
check out the brochure!**

