

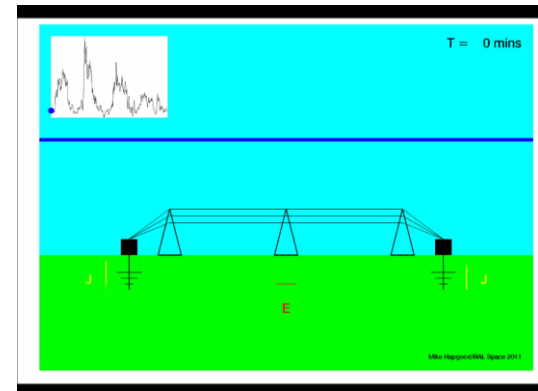

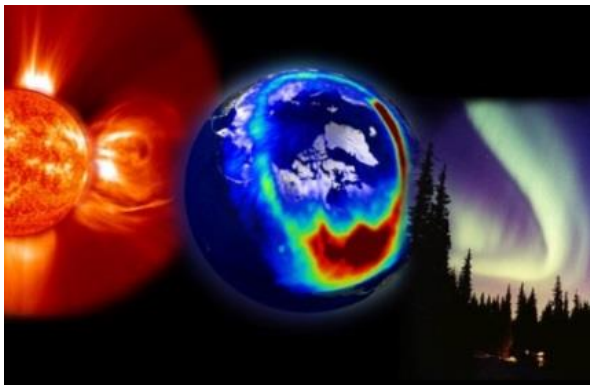

# Space Weather and Small Satellites: A UK Perspective

Mario M. Bisi (RAL Space, UKRI-STFC, UK), Mike Hapgood (RAL Space, UKRI-STFC, UK), David Jackson (Met Office, UK), Yulia Bogdanova (RAL Space, UKRI-STFC, UK), Sean Elvidge (University of Birmingham, UK), Keith Ryden (Surrey Space Centre, UK), Jonathan Eastwood (Imperial College, London, UK), Anasuya Aruliah (UCL, UK), Chiara Palla (Imperial College, London, UK), Patrick Brown (Imperial College, London, UK), Andy Vick (UKRI-STFC-RAL Space, UK), and Stuart Eves (SJE Space Ltd, UK).



- Mark Gibbs (Met Office, UK)
- Matt Angling (SPIRE Global, Inc., UK)
- Richard Harrison (RAL Space, UKRI-STFC, UK)
- Mark Prouse (Department for Business, Energy, & Industrial Strategy – BEIS, UK)
- Laura Cooke (Department for Business, Energy, & Industrial Strategy – BEIS, UK)
- Thomas Madden (Department for Business, Energy, & Industrial Strategy – BEIS, UK)
- Jackie Davies (RAL Space, UKRI-STFC, UK)
- Catherine Burnett (Met Office, UK)
- Chris Perry (RAL Space, UKRI-STFC, UK)
- Edward J. Oughton (Oxford University, UK)

- 
- A visualization of space weather showing the Sun on the left, emitting solar wind that interacts with Earth's magnetic field on the right, creating a complex structure of magnetic field lines and plasma. The background is a starry space.
- Part 1: The UK position on space weather.
  - Part 2: Small satellites and space weather in the UK.
  - Part 3: Future larger missions and summary.

# The UK position on space weather.

## An overview (Venn diagram) of the UK Government's Governance of Space Weather...

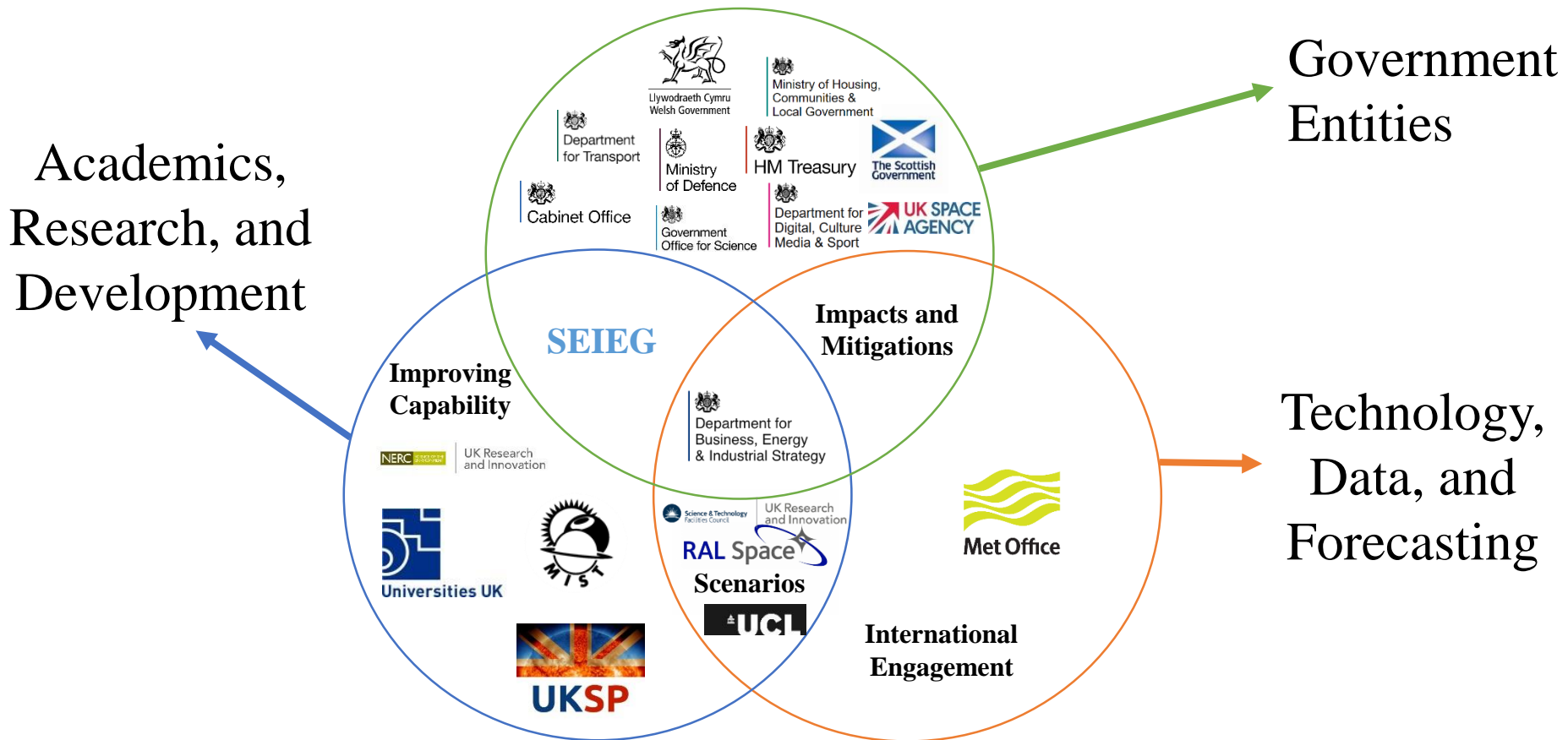

- Adapted from: Mark Prouse, Laura Cooke, and Thomas Madden (Department for Business, Energy, & Industrial Strategy – BEIS, UK) <sup>5</sup>

## Space Weather is a Natural Hazard...

...because:

Flooding	People, homes, and infrastructure on flood plains and coasts.
Tsunami	People, homes, and infrastructure near coast.
Volcanoes	People, homes, and infrastructure on pyroclastic and lava flow lines.
Space weather	People, homes and infrastructure near a star!

- Natural hazards occur in places that are good to live and occasionally dangerous.
- Scale and frequency of extreme risks is a key concern.

# Assessing the Risk

- UK's National Risk Register (NRR –



National Risk Register

Impact					
Catastrophic (5)					Pandemic influenza
Severe (4)				Coastal flooding Widespread electricity failure	
Moderate (3)		Major transport accidents Major industrial accidents		Effusive volcanic eruption Emerging infectious diseases Inland flooding	<i>Severe space weather</i> Low temperatures and heavy snow Heatwaves Poor air quality events
Minor (2)		Public disorder Severe wildfires		Animal diseases Drought	Explosive volcanic eruption Storms and gales
Limited (1)				Disruptive industrial action	
Probability in next 5 yrs	1-in-20000 to 1-in-2000	1-in-2000 to 1-in-200	1-in-200 to 1-in-20	1-in-20 to 1-in-2	> 1-in-2

## The advent of Space-Weather



# Met Office Space Weather Technical Forecast

## Space Weather Technical Forecast (Ref: MO43)

Issued on Wednesday, 11 March 2015 at 00:42 local

This scientific guidance document provides a four day assessment of space weather events. The probabilities stated below are for reaching or exceeding the given levels. For more information about space weather impacts please see the Met Office Space Weather Scales [http://www.metoffice.gov.uk/media/pdf/i/7/Space\\_weather\\_scales.pdf](http://www.metoffice.gov.uk/media/pdf/i/7/Space_weather_scales.pdf)

**Space Weather Forecast Headline: M-class flares likely (70%). Slight chance (20%) of X-class flares.**

### Analysis of Space Weather Activity over past 24 hours

**Solar Activity:** Solar activity has been High during the past 24 hours, with an M5 flare observed at 10/0324 UTC, and several C-class flares, all originating from Region 2297, currently the only active



These reports have collectively provided valuable information for UK Government Departments trying to understand what their vulnerabilities to space weather might be and are used to inform the development of proportionate risk mitigation strategies...

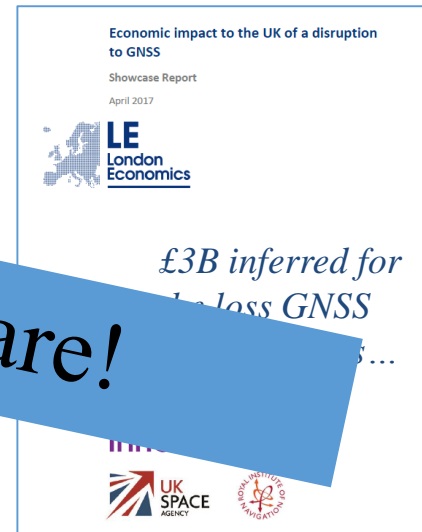
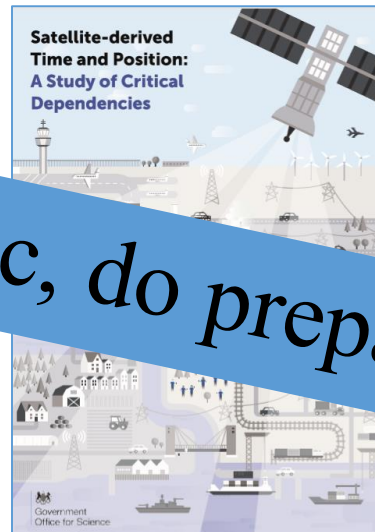

*Don't panic, do prepare!*

## Optimising the Risk Equation...

- The “Triangle of Pain”...
- Who Bears the Risk?
- Who Benefits from Resilience?

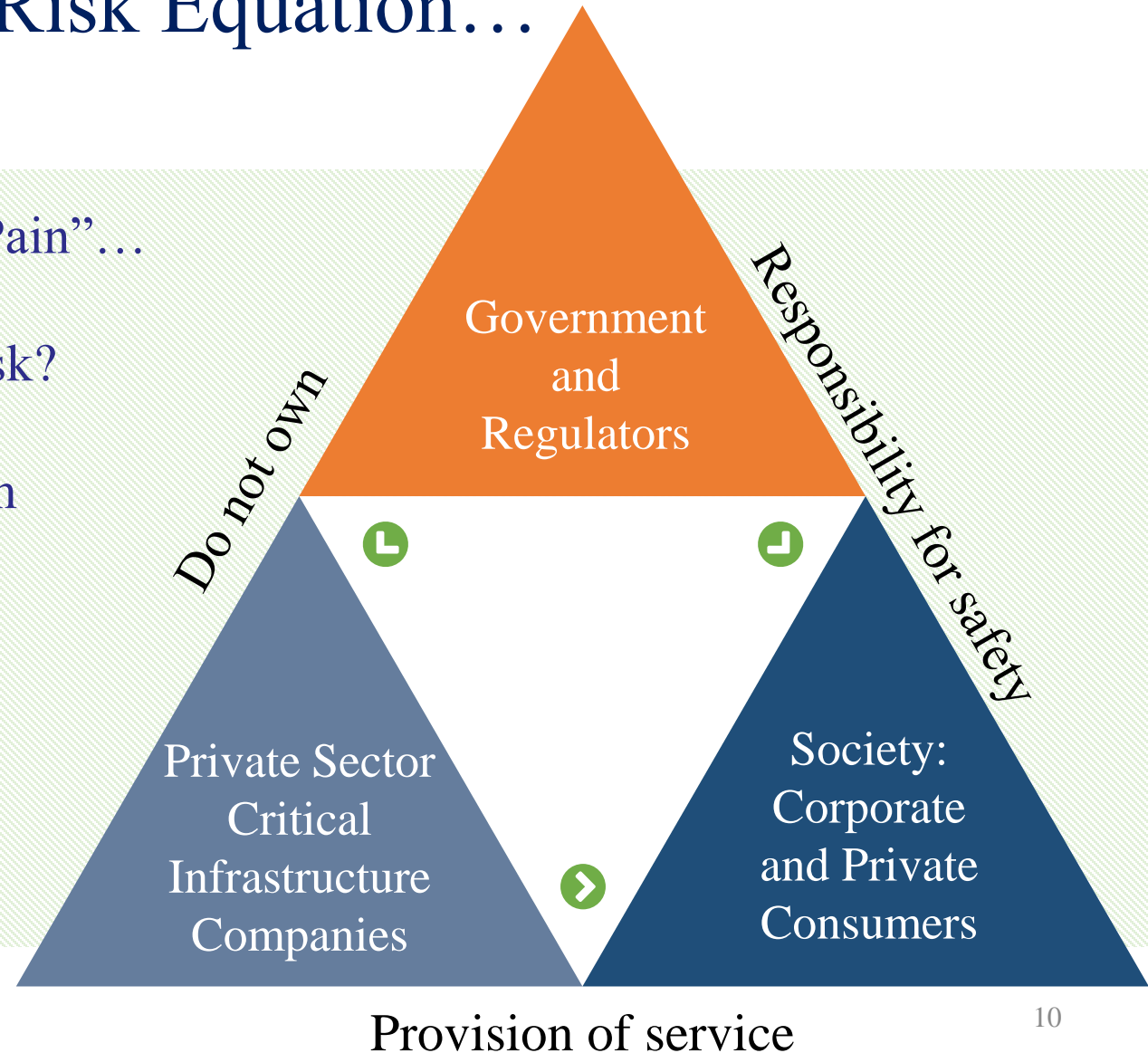

## Reasonable worst-case scenario and understanding:

- The risk and scenarios have to be regularly monitored and updated (guided in the UK case by the Space Environment Impacts Expert Group – SEIEG).
- *All aspects of society are interconnected making this a difficult task!*
- A clear financial benefit is derived from space weather forecasting.
  - Lessons learned from completed socio-economic studies (*e.g.* UKSA IPSP, University of Cambridge, *etc...*), and these are and will be applied to future pertinent studies.
  - Wider UK impact (with current forecasting) from the IPSP moderately-severe event case was ~€5B, but across Europe (including Scandinavia) suggested impacts of up to €82B.
  - Loss of power costs far outweigh the civil aviation – but other sectors need greater study.
  - Similar such impact costs were derived by an ESA socio-economic study.

# Small satellites and space weather in the UK.



- Long history of exploiting small satellites for SW:
  - Started with UoSATs in the late 1980s and 1990s with the CREDO (Cosmic Ray Effects and Dosimetry Experiment);
    - CREDO and many decedents have flown on some tens of missions (*e.g.* PoSAT, KiTsat...)
  - The STRV satellites (50kg) also contributed a lot in the 1990s carrying CREDO and new monitors like SURF into the unusual and interesting GTO orbit.
  - Since 2005, Surrey Space Centre (University of Surrey) staff have been observing space weather with the Merlin instrument in MEO (Galileo) orbit and this is on-going and the unit is still working.
  - Studying a potential small mission to the inner belt since there are now scientific questions regarding its variations but launch opportunities are a challenge (maybe UK launchers could help).
- Technology demonstration in the real space radiation environment is also an important role of small satellites.

- UKube-1 was successfully launched on 07/08/2014 at 1558UT aboard a Soyuz 2-1b/Fregat-M rocket from Baikonur Cosmodrome.
- A 3U satellite which measures 10 cm x 10 cm x 30 cm and is the first mission commissioned by the UK Space Agency.
- It is the first satellite to be designed and manufactured in Scotland.
- UKube-1 contains three scientific and research payloads as well as FUNcube-2 (amateur radio payload).
- UKRI-STFC RAL Space provided the Ground Station for the mission at Chilbolton Observatory (including commanding of the spacecraft).

- On 15/07/2018 the UK Government announced the locations where UK vertical and horizontal direct access to space launch capabilities will be placed.
  - Sutherland, Scotland, was chosen for the vertical launch spaceport location.
  - Cornwall (Newquay spaceport) will partner with Virgin Orbit for horizontal launch capability from the airport.
- Represents the strong UK Space interest from Government and industry as well as from academia.
- Provides many prospects for future UK satellites home grown and launched from home soil.
- Boost to international collaborations for and in space.
- Prospects for UK space weather small satellites to be brought forward more easily.

# University of Birmingham

- Designed and prototyped an inflatable helix antenna
  - Demonstrated the viability of a partially metalised rigidisation technique for inflatable structures
  - For use on future trans-ionospheric sounding missions
  - In collaboration with University of Strathclyde
- Designed and built the ionospheric Impedance Probe (ImP)
  - Tiny instrument for in-situ measurements of electron density
  - Can be used as either
    1. Secondary payload on satellite
    2. Hosted on constellation of small satellites (PocketQube, 5cmx5cmx5cm)
- Developing next-generation data assimilation models to forecast thermospheric densities
  - Advanced Ensemble electron density (Ne) Assimilation System (AENeAS)
  - Used for satellite conjunction analysis





# RADCUBE

## • What?

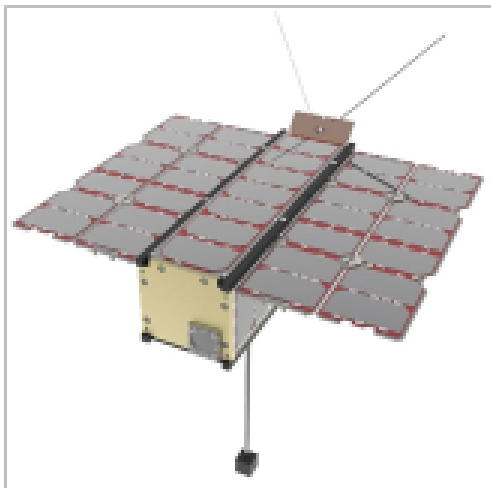

- 3U CubeSat, developed in ESA's GSTP programme
- Imperial's MAGIC magnetometer is part of the RadMag payload

## • Who?



Imperial College  
London



## • Why?

- Demonstrate miniaturised instrument technologies in LEO for space weather monitoring
- MAGIC goal: monitor field aligned currents and ring current during geomagnetically disturbed conditions

## • Where and when?

- Launch planned in 2020 to Sun-synchronous LEO
- Status: approaching CDR



## • RadMag payload (1.2 U volume)

80 cm boom

MAGIC

- For more information contact [jonathan.eastwood@imperial.ac.uk](mailto:jonathan.eastwood@imperial.ac.uk)

# Comparing QB50 height decay (launched 2017) with original model prediction made in 2014

The time axis is adjusted so that cubesats at same start height.  
Note that low solar activity delays de-orbiting.

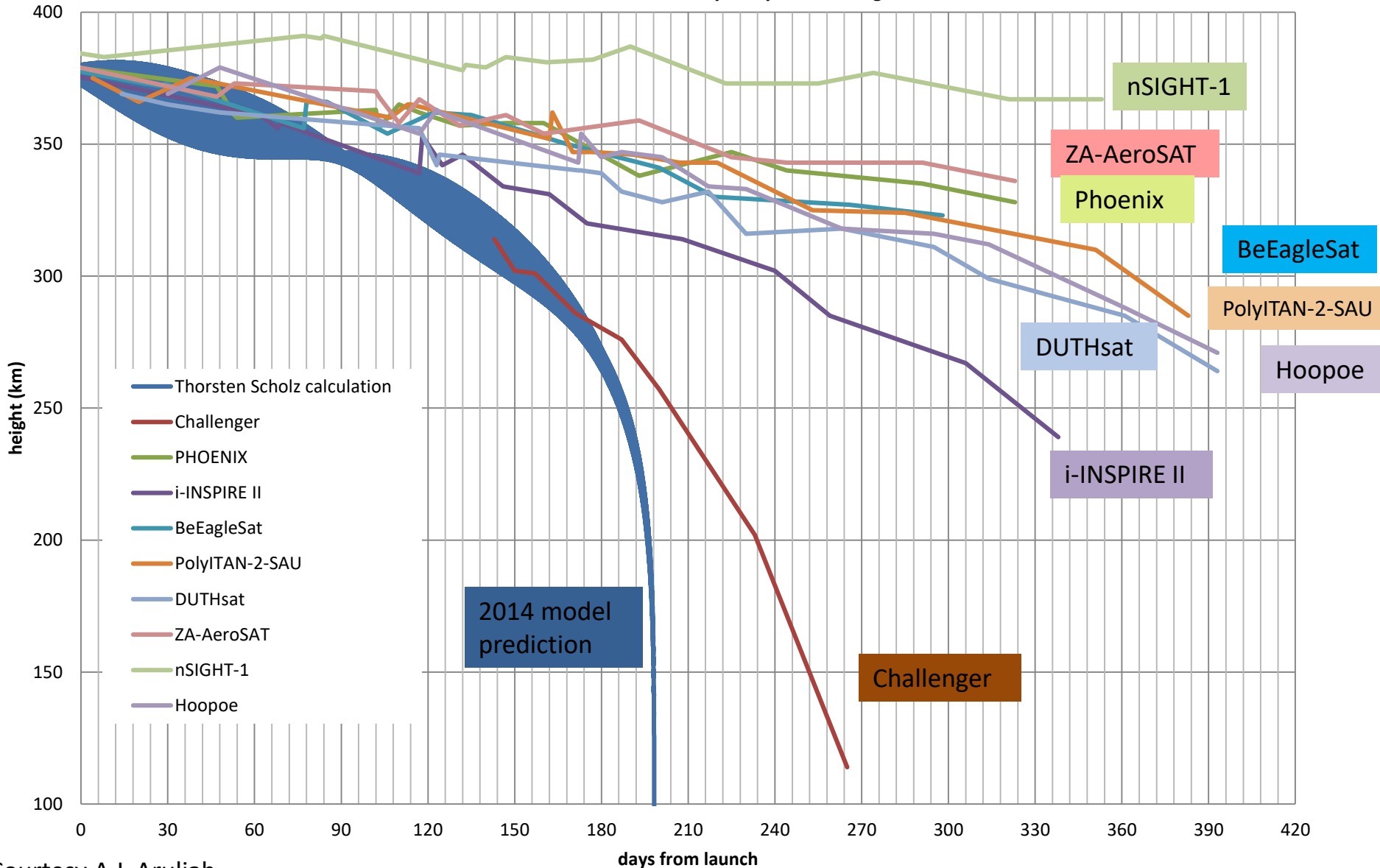

# Preliminary results from the INMS on the PHOENIX CubeSat (Taiwan) compared with the CMAT2 model

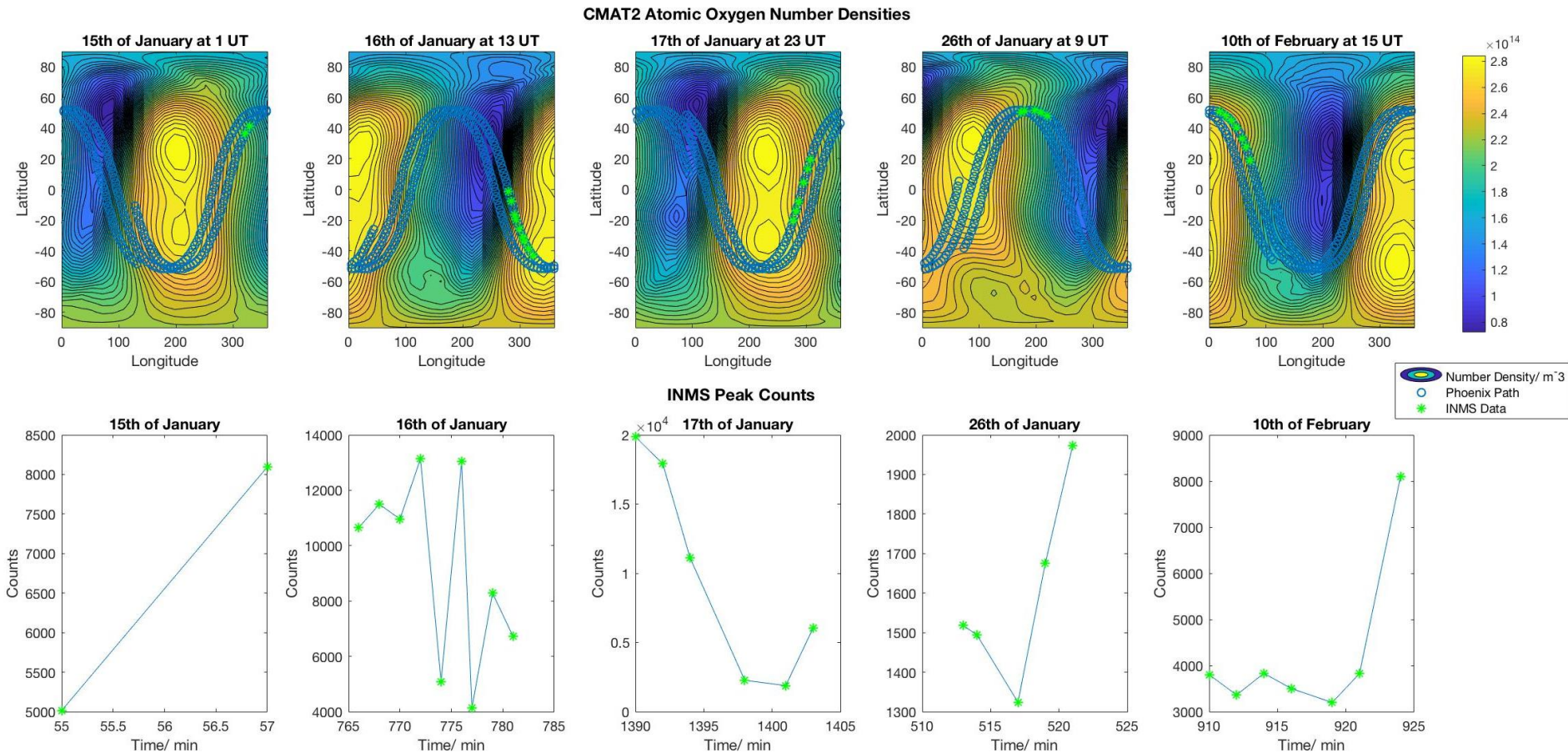

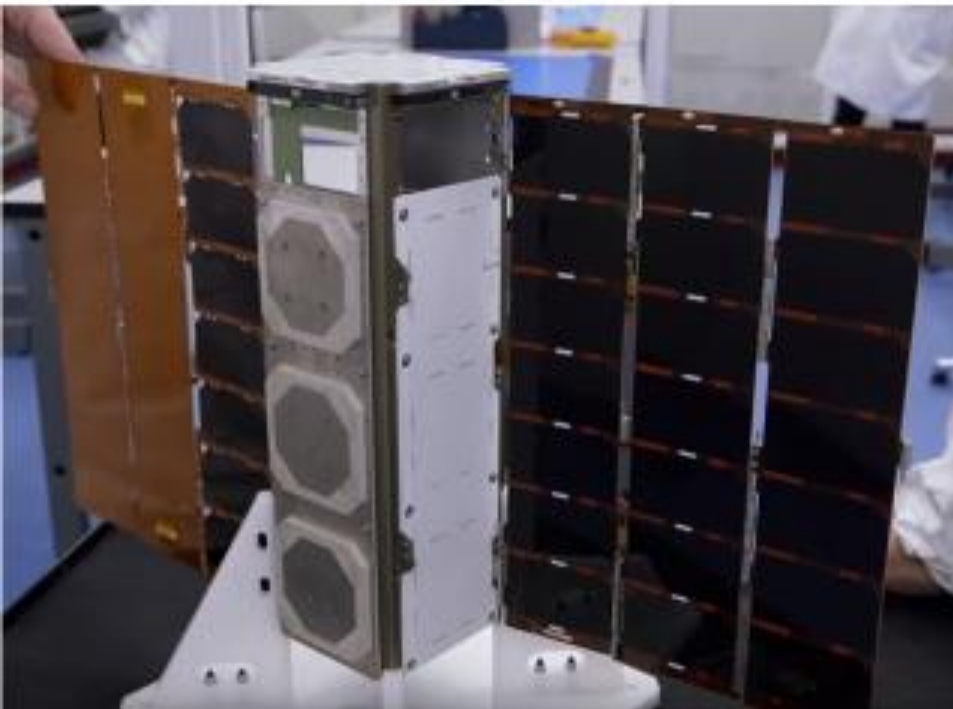

Latest LEMUR2 v3.4 satellite bus

## SPIRE GLOBAL, INC.

- Leading player in nanosatellite sector
- 80+ 3U nanosatellites launched
- 6 months from design to launch
- Designed for a lifetime of 2 years to ensure constellation is updated with newest technology
- 30+ ground stations globally to ensure low latency
- Providing rapidly refreshed data
  - AIS (ship tracking)
  - **GNSS Measurements for Space Weather**
  - ADS-B (commercial aviation tracking)
  - GNSS Reflections under development

# SPACE WEATHER MEASUREMENTS

- Sats carry state-of-the-art GNSS science receivers for iono/RO
- Ionospheric information derived from dual frequency GNSS signals
  - Slant total electron content (TEC)
  - Scintillation events
  - Electron density profiles
- Spire constellation provides these observations at unprecedented coverage
  - Data denied areas
  - Low latency
- Expected growth to 16M TEC observations/day
- Assimilation into models for improved space weather forecasting predictions

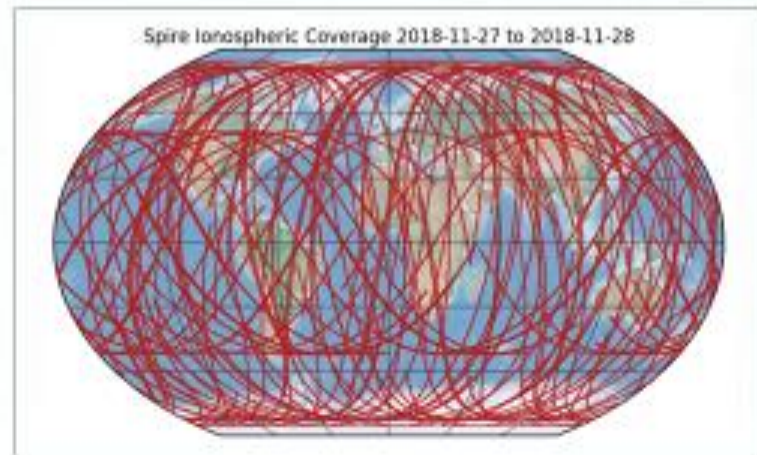
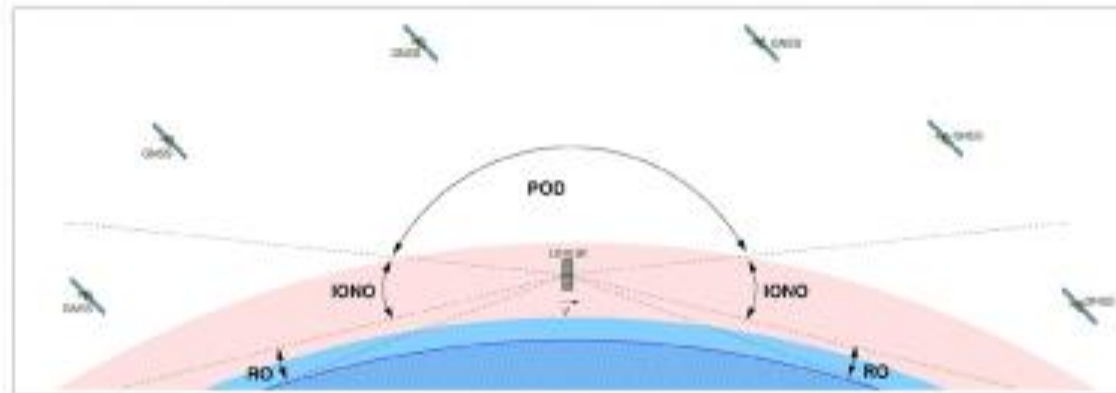

# Highly Miniaturised Radiation Monitor

- The HMRM is a real-time radiation monitor which provides additional scientific data set of reconstructed particle spectra, targeting **35 keV-6 MeV electrons** and **600 keV – 500 MeV protons** with maximum particle flux of  $10^8 \text{ \#/s/cm}^2$ .
- Combines scientific capabilities with small size ( $<15 \text{ cm}^3$ ), low mass (50-100 g), low power ( $<1.8 \text{ W}$ ) and cost.
- Employs unique disruptive technology, based on the CMOS Active Pixel Sensors integrated on the bespoke ASICs.
- Current status: phase A/B completed in 2018 under ESA contract.
- Ideal for the hosted payload applications and for the use on small satellites.

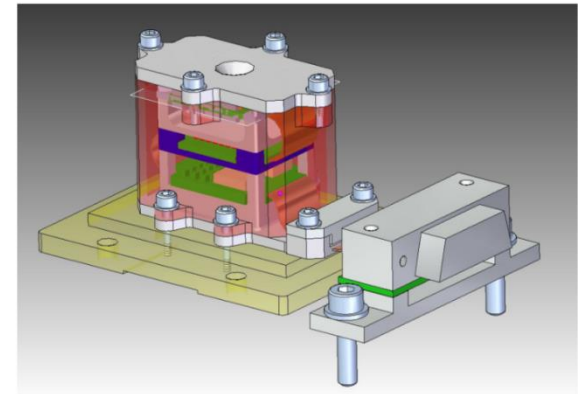

# Future larger missions and summary.

## Ongoing UK Developments and Priorities

- National Risk Assessment (and hence NRR) updated:
  - Loss of GNSS and economic impacts improved; and
  - Adjustments for increases in knowledge, understanding, and current capabilities.
- Table top exercises continue to improve knowledge and understanding.
- UK commercial services of interest (including military applications).
- UK Space Weather Strategy being developed:
  - Includes close working with the USA on the Benchmarks activities.
- UK national GNSS capability is starting to be tabled in lieu of Galileo.
- UK continues to see UK-led ESA L5 mission a priority.
- UK has an interest in other avenues for space-weather data, forecasting, modelling, and potential backup/fall-back options; *e.g.*:
  - Increased number of radiation monitors on satellites; and
  - Use of IPS as part of the Worldwide IPS Stations (WIPSS) Network and investigating potential use of heliospheric Faraday rotation (FR).



- **Space weather is very complex with real-world impacts, it comes in multiple strands with local, regional, and global impacts requiring national and international working/funding!**
- *Economic studies have shown the large-scale impacts even moderately-severe space weather can have.*
- Severe and everyday space weather are internationally-recognised risks which require adequate forecasting/warnings and need dedicated space-weather missions, new data streams, and improvements to Sun-to-Earth modelling.
- *The UK is keen to build future space-weather capabilities and this can include small-satellite solutions.*
- The UK will ensure it is resilient and able to respond to a Severe Space Weather Event on the basis of Proportionate Risk Mitigation.
- *Development of the UK SWx Strategy is in progress; there will be further engagements with the key stakeholders throughout.*