

# HyperGES

## The ESA Large Diameter Centrifuge (LDC)

Dr.ing. Jack J.W.A. van Loon

Cooperate Scientist @ ESA-ESTEC-TEC-MMG Lab, Noordwijk, The Netherlands

&

Dept. Cranial-Facial Surgery, ACTA &  
 VU University Medical Center, Amsterdam, The Netherlands

Email: [j.vanloon@amsterdamumc.nl](mailto:j.vanloon@amsterdamumc.nl)



1975 Signing of ESA Convention

10

MEMBER STATES

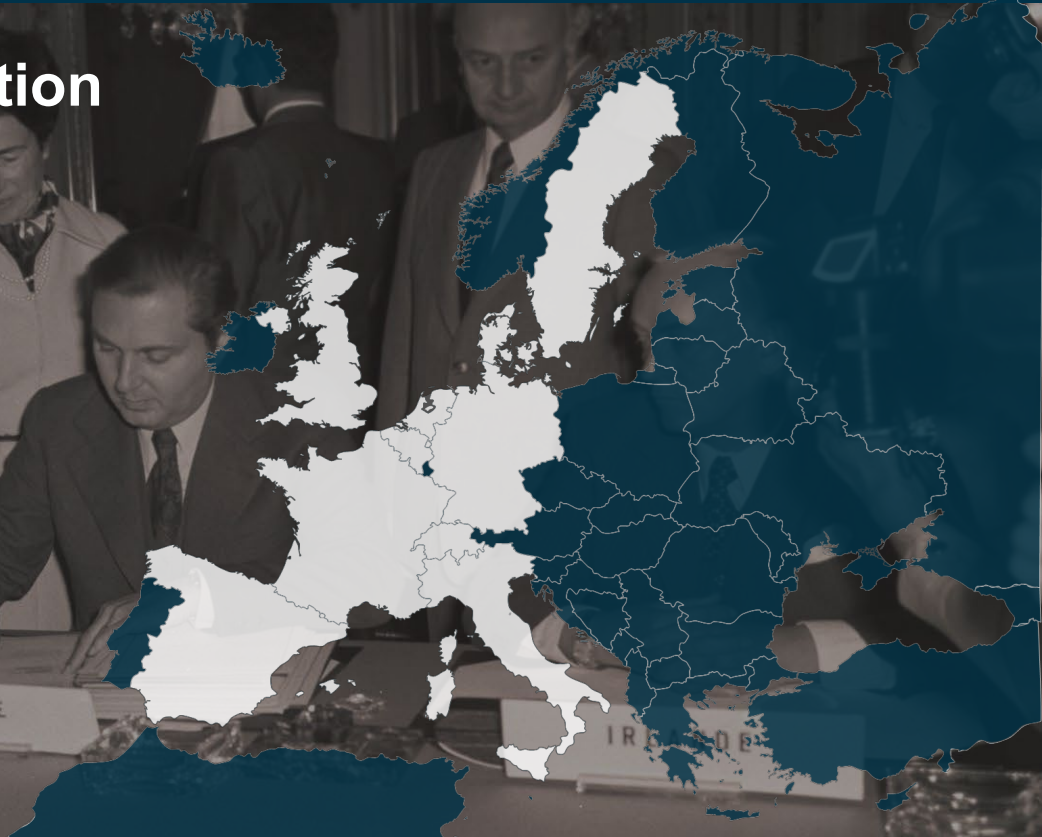

22

MEMBER STATES

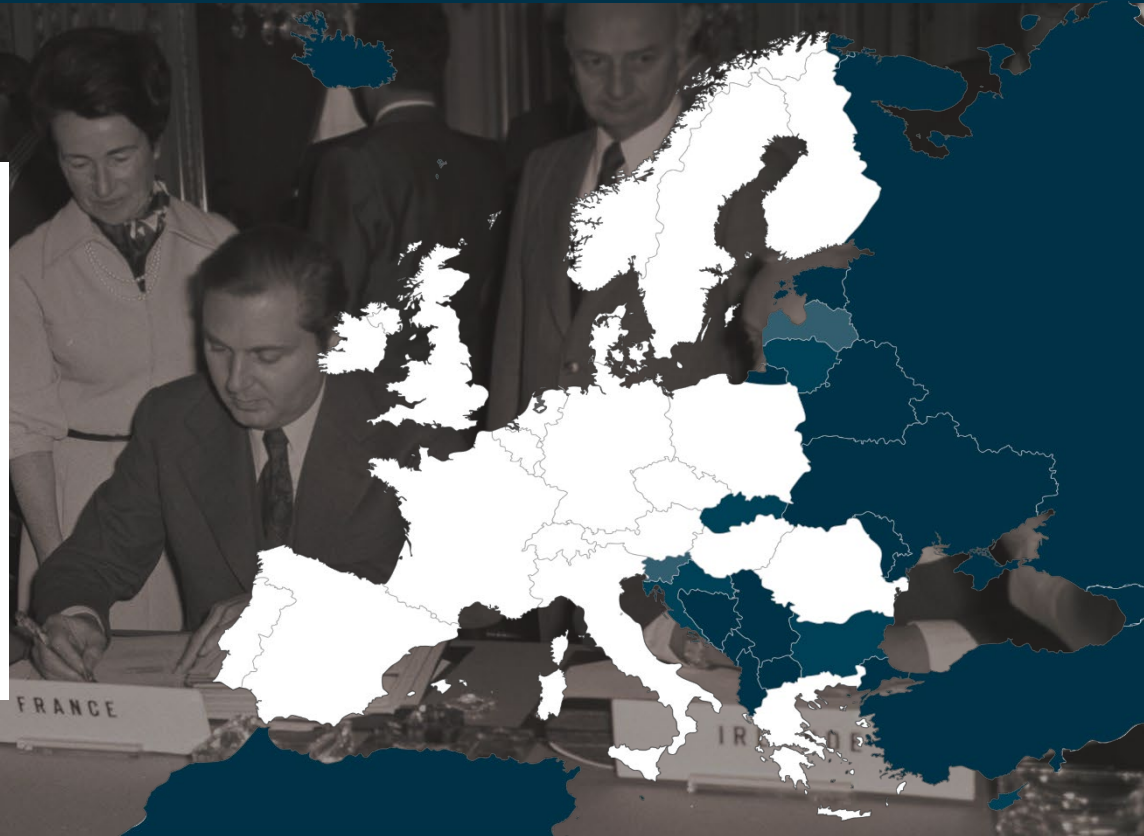

# ESA Establishments (1)



## Headquarters

Located in **Paris**, home to the main programme directorates that steer and formulate ESA policy.

## ESRIN

ESA's centre for Earth observation activities, near **Rome**, Italy, also develops information systems and hosts the Vega launcher project.

## ESTEC

The European Space Research and Technology Centre, **Noordwijk**, the Netherlands, is the largest site and the technical heart of ESA.

## ESOC

The European Space Operations Centre, **Darmstadt**, Germany, tracks and controls European spacecraft.

## EAC

The European Astronaut Centre, **Cologne**, Germany, trains astronauts for missions to the International Space Station and beyond.

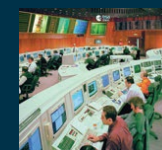



## ESAC

The European Space Astronomy Centre, near **Madrid**, Spain, hosts the science operation centres and archives for ESA's astronomy and planetary missions.



## Harwell (ECSAT)

Harwell Centre, in **Oxfordshire**, UK, is focusing on commercialisation and partnerships in space activities.



## Redu

**Redu** Centre in Belgium is part of ESA's ground station network and is also home to ESA's Space Weather Data Centre.

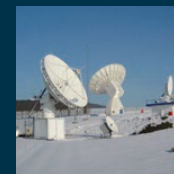

## Guiana Space Centre

ESA's launchers lift off from Europe's Spaceport in **Kourou**, French Guiana. It is jointly operated by the French space agency (CNES) and Arianespace with the support of European industry.



# ESA-ESTEC, Noordwijk, NL



the 'Center of Gravity'

# TEC-MMG Lis Lab @ ESA-ESTEC

Life- and Physical Science Instrumentation Laboratory (LIS)



Jack van Loon



Alan Dowson



Francois Gaubert



Robert Lindner

flow benches

meeting room



clean room



(fluor.) mic.s



plant chamber



MidiCAR



RPMs

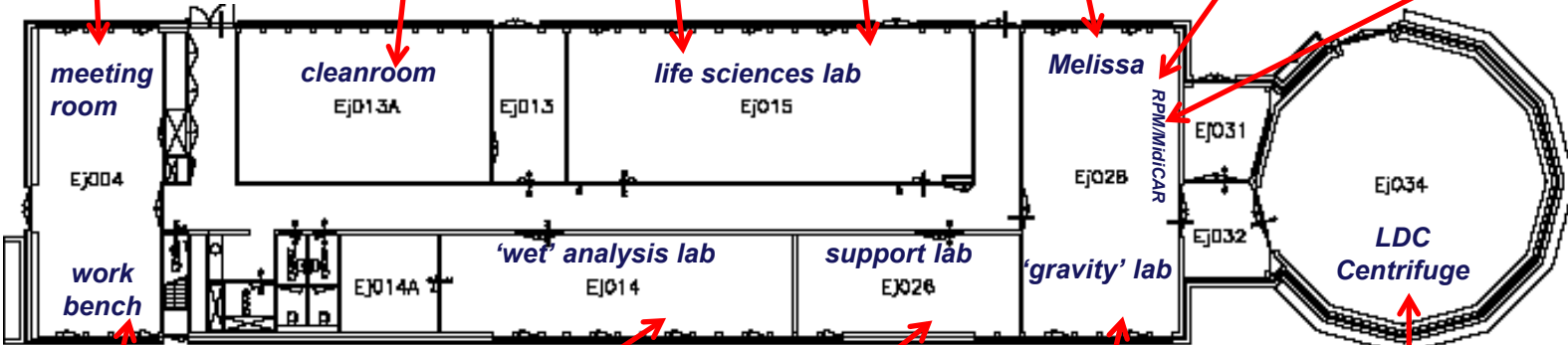

+ other ESTEC labs !!

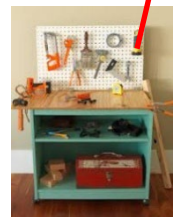

workbench



LC/MS



e.g. autoclaves



clinostats



LDC

# LisLab – LDC Facilities @ ESA-ESTEC

Life- and Physical Science Instrumentation Laboratory (LIS)



main lab



support lab



LDC control room



meeting room



small 'workshop'



LDC prep lab



'wet lab'



# Current vs. 'Future' Spaceflight Research

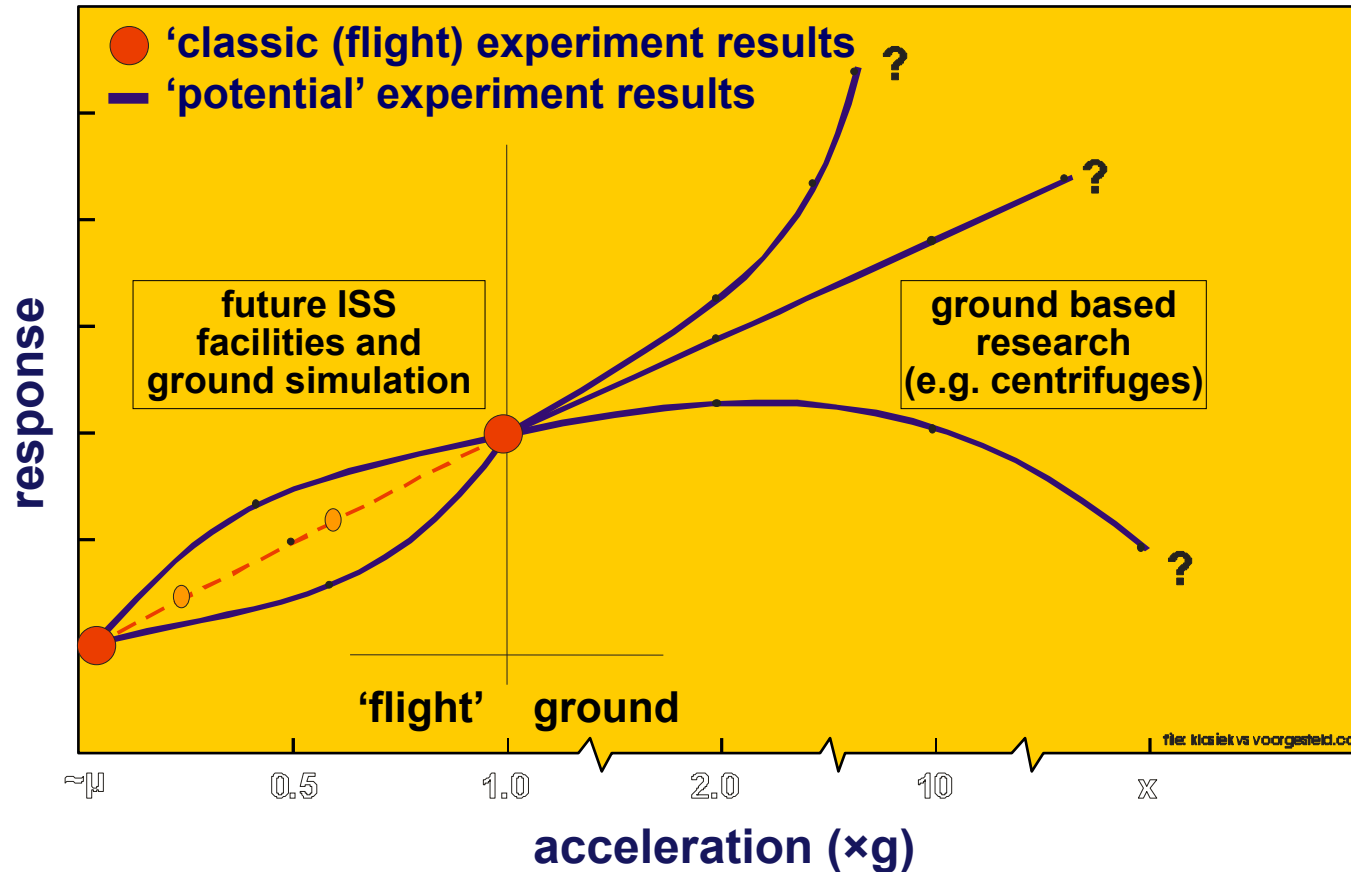

Schematic presentation of potential experiment opportunities compared to 'classic' experiment setups. Novel space station facilities as well as ground simulations and centrifuges may be applied to study the role of weight (accelerations) on various living and non-living samples.

# Large Diameter Centrifuge

- Regular hypergravity
- Launch simulations
- Parabolic Flight hyper-g phase exploration
- ....

Gravity Continuum

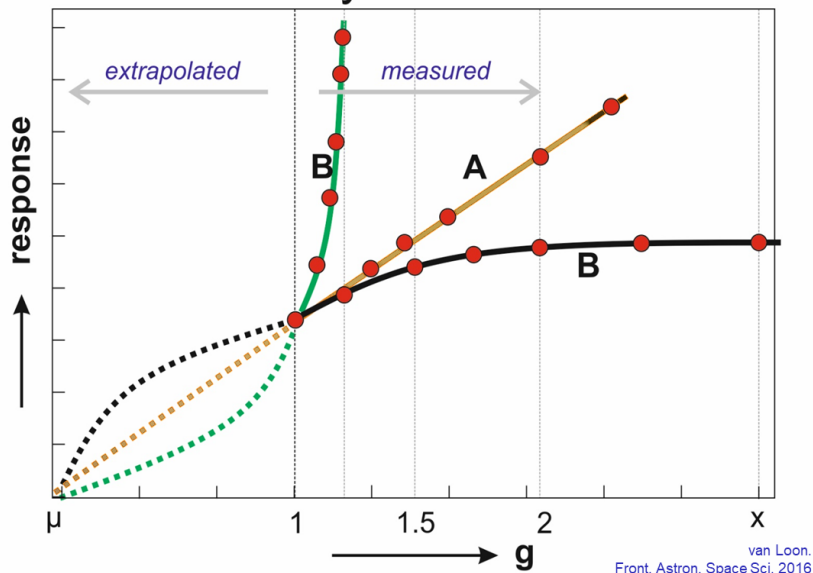

The 'Reduced Gravity Paradigm' (RGP)

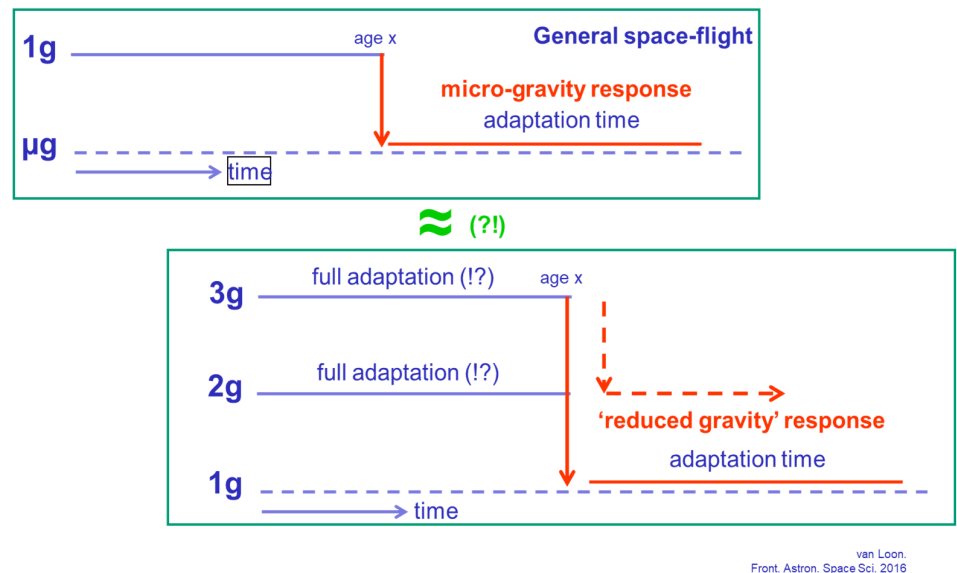

# LDC Main Properties

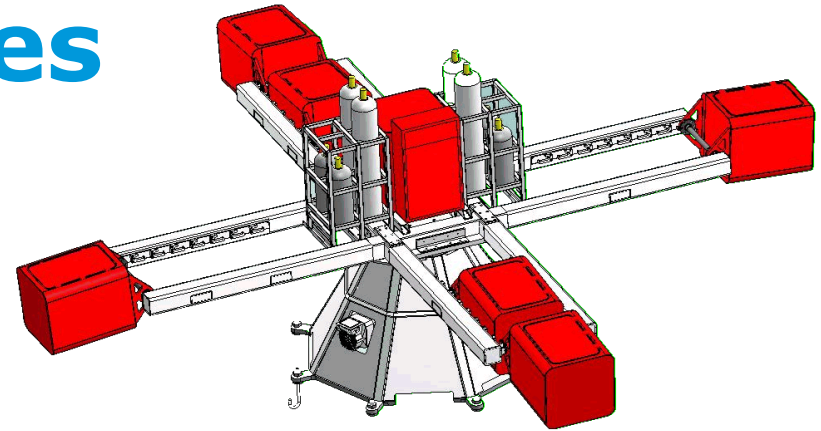

**diameter :** ~ 8 meter

**arms :** 4

**g levels :** various (8 locations / arm)

**exp. Volume:** 7 'gondolas' ; 6 rotating (60×60×80 cm)

**center gondola:** control / g-sensitive materials

**g vector :** swing-out: 

**payload :** 80 kg per gondola (total 210 kg incl. gondola)

**g load :** 20×g fully loaded

**motor :** 22 kW (Siemens)

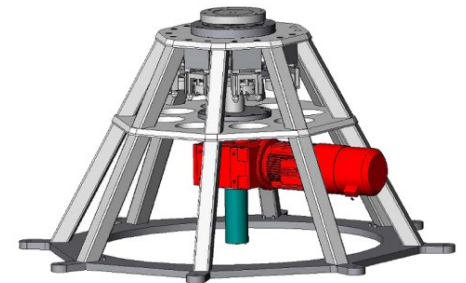

# The Gondola : Main Properties

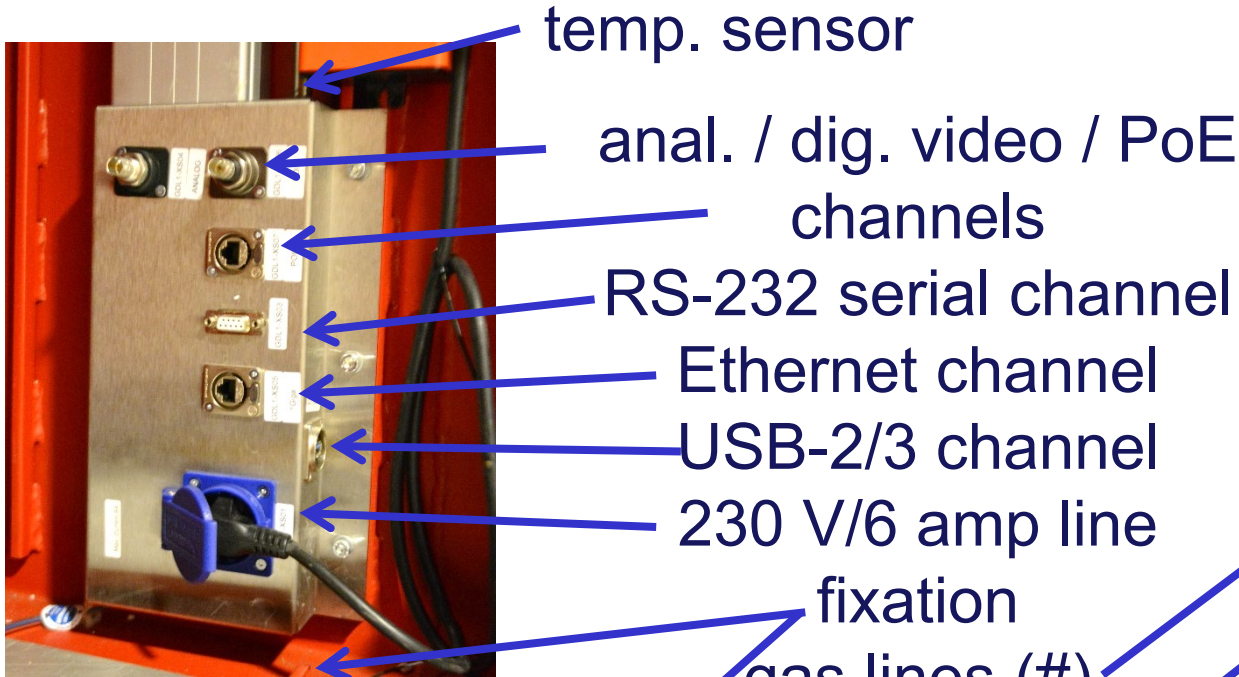

power / data

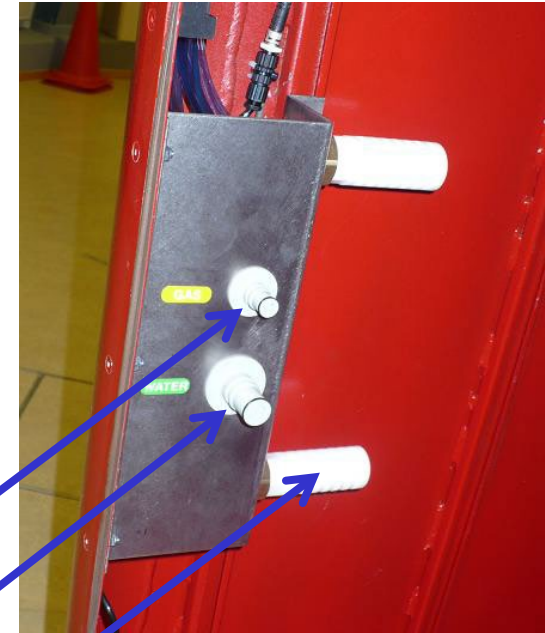

fixation  
gas lines (#)  
water supply  
forced ventilation

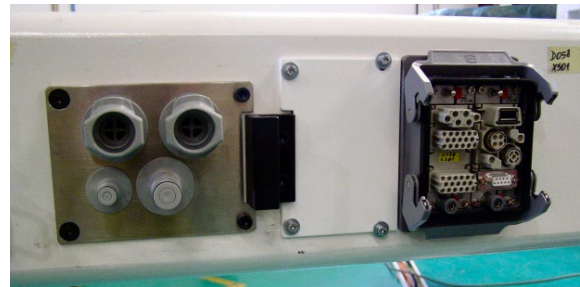
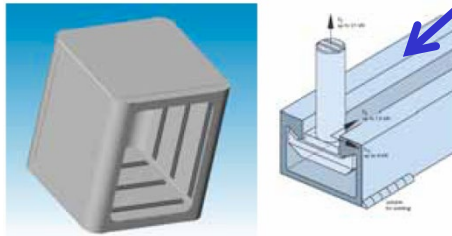

gondola connections



9 analogue video lines /  
8 digital video lines

# LDC Data / Electronics Interfaces

## Operation Electronics Scheme

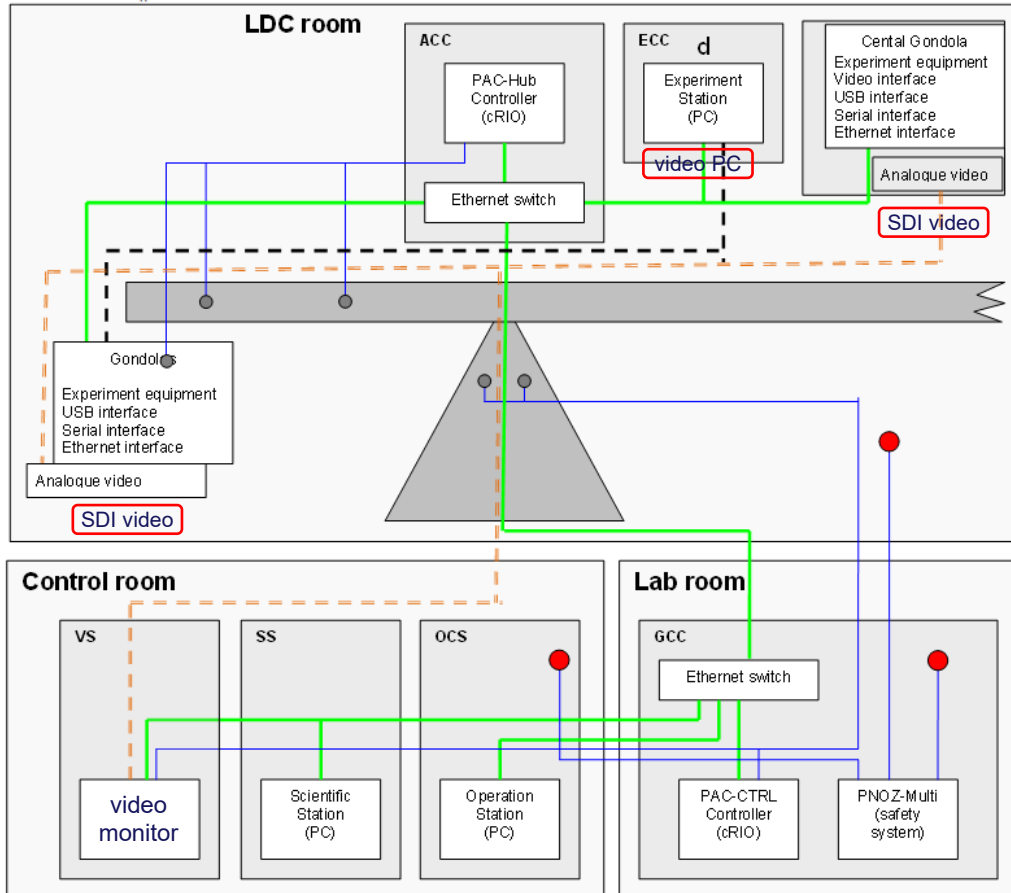

- Ethernet connection
  - - - USB/serial connection
  - Analog/digital signals
  - Emergency stop devices
  - - - Analogue video line (BNC)
  - Sensors
  - Emergency stop devices
- ACC** Arms Control Cabinet
  - ECC** Experiment Control Cabinet
  - GCC** General Control Cabinet
  - OCS** Operation Control Station
  - SS** Science Station

## Operation Data Flow Scheme

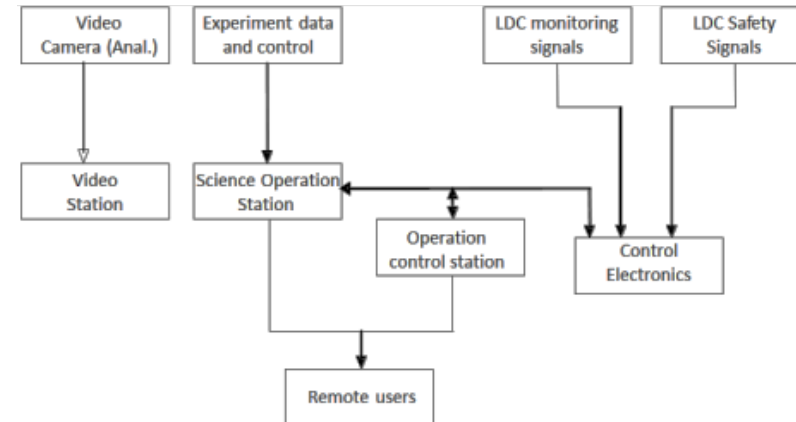

### Data / Communication:

- Remote PC (Win10 / (Win7/XP!), non-Win systems) **(administrator rights!!)**
- (TeamViewer)
- Exp. dedicated

# LDC Swing-Out / Integration

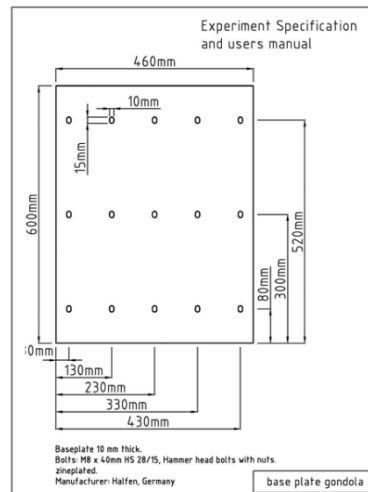
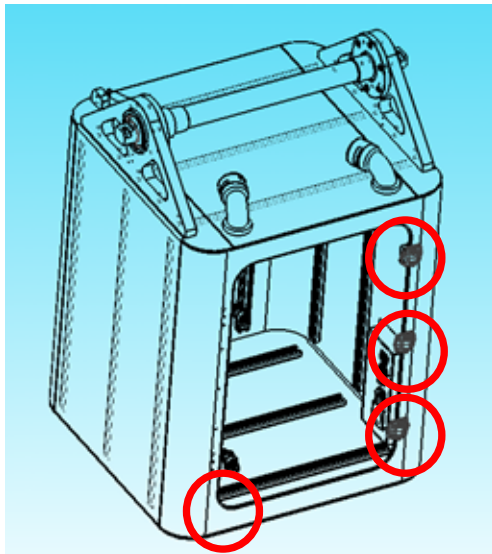
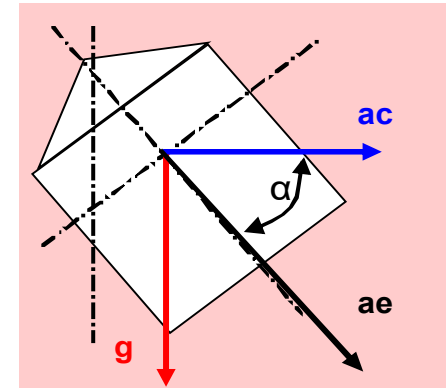
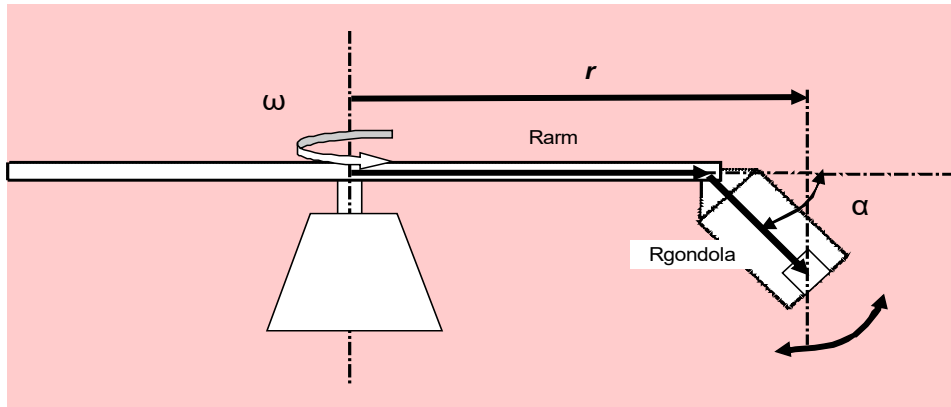

Door clearance: 450× 710 mm (WxH)  
(max. approximately; round corners,  
hinges)

Working space inside: 500×500 × 720 mm

Base plate  
(mostly not  
needed)

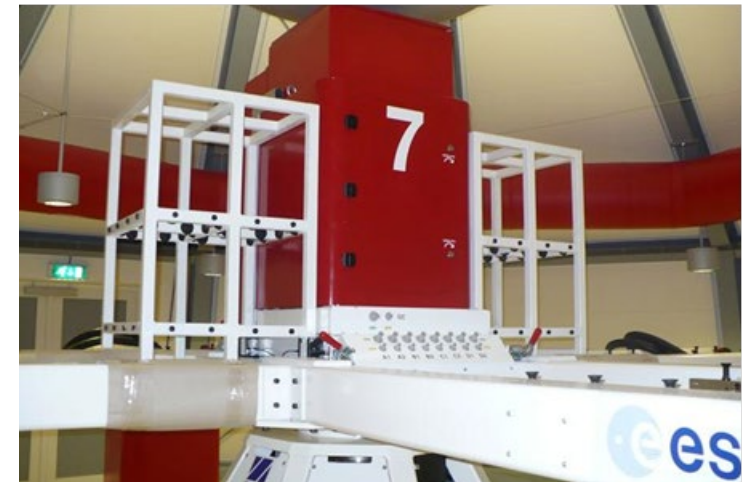

Gas / fluid containers

# LDC Start-up & Profiles

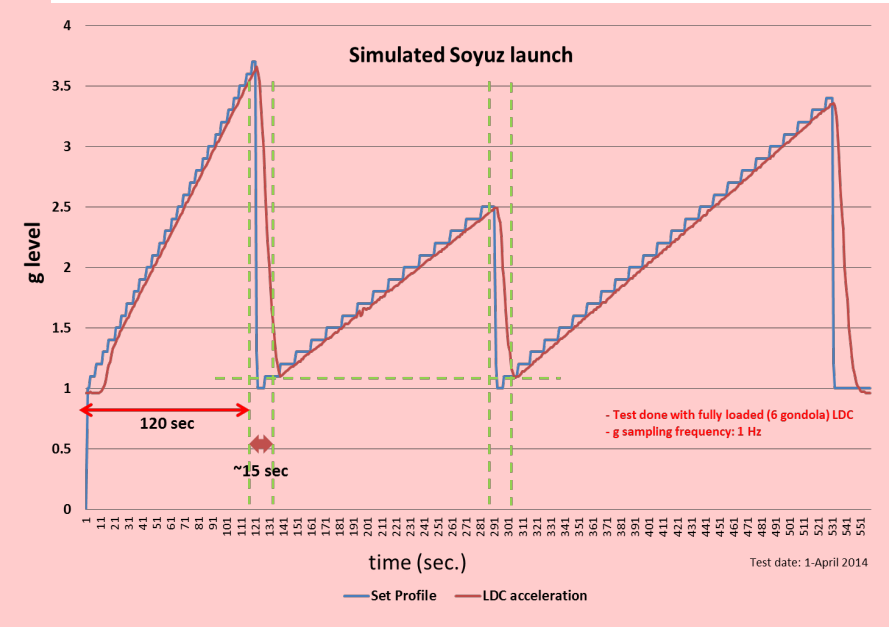
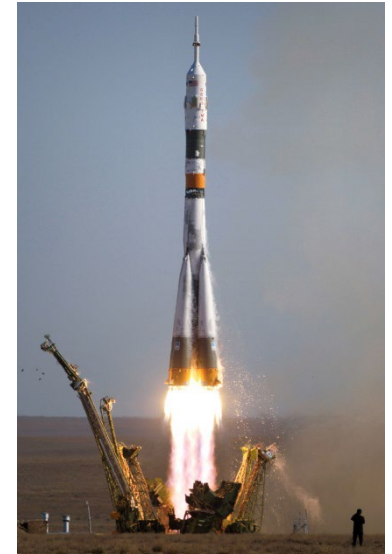
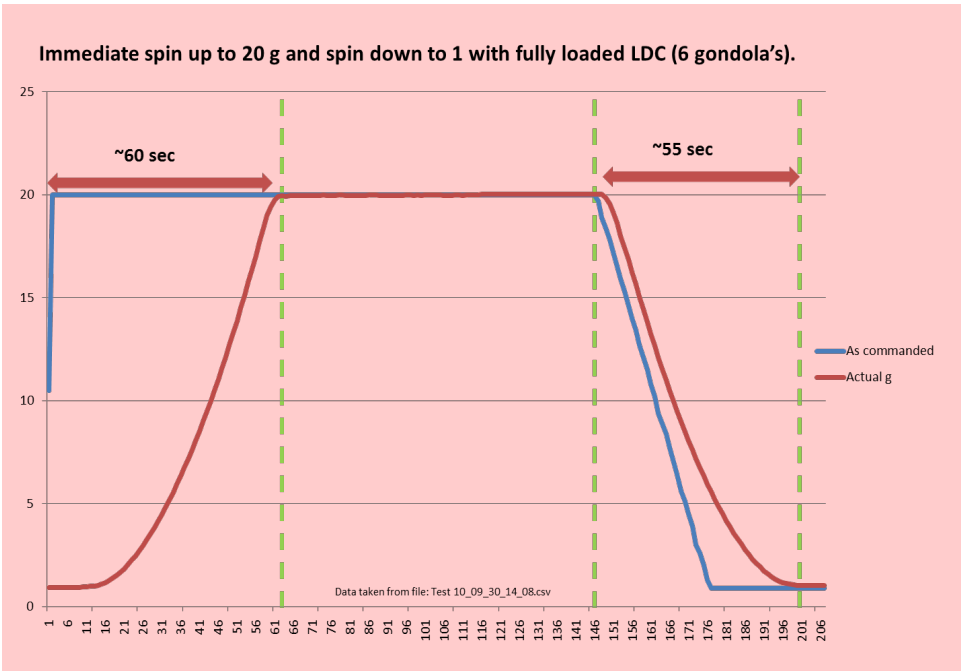

# The Gondola : Gravity Profile / Inertial Shear

total load distribution due to rotation  
(no Earth 1g)

(19.515 – 19.690)

bottom of gondola

place sample @  
center !

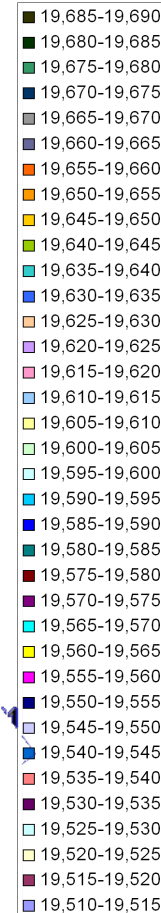

**20g**, longest arm  
total surface area  
600×600 mm

max. gradient / inertial  
shear over full surface  
area:

- @ 80 cm: 0.6%
- @ 40 cm: 0.7%
- @ 0 cm: 0.9%

gradient over gondola  
height: **10.3%**

**Place sample in center of gondola !!**



# LDC Experiment Capacity

Multiple g-levels (~factor 2)

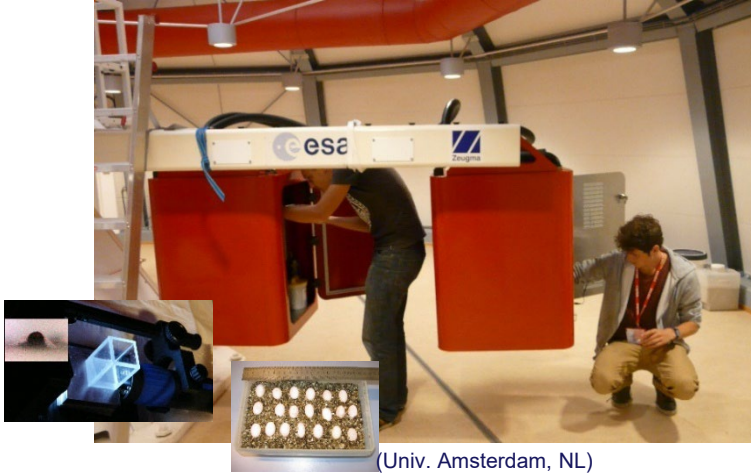

Different temperatures (~4-40 °C)

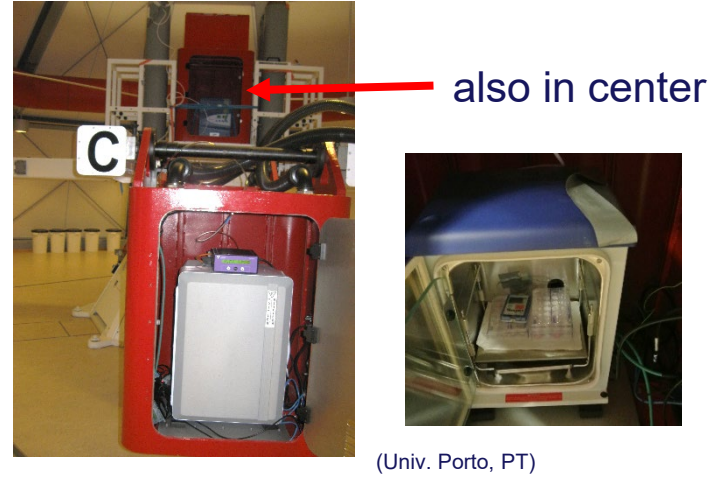

increase exp. n !

Multiple Gondolas

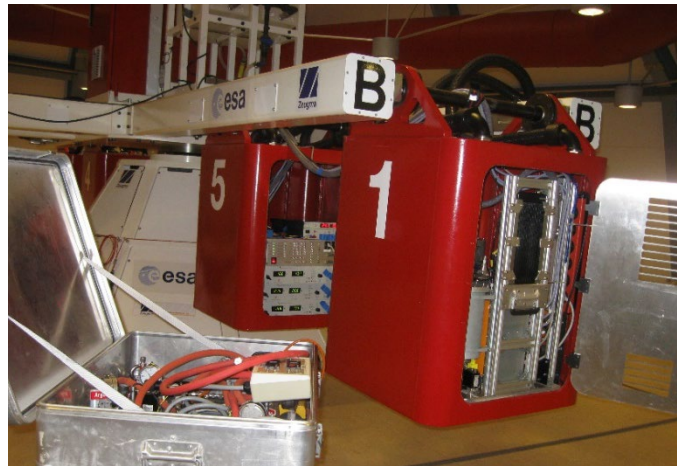

(MAP: Aachen et al. DE)

Lab Pre-integration



(ASML/TU/e, NL)

# Some Experiment Configurations



**Impact**  
(Glasgow, UK)



**Crab/Neurovestibular**  
(Aberdeen, UK)

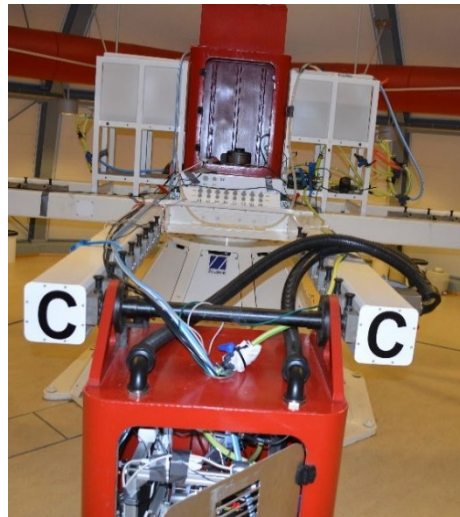

**Mass & Heat Transfer**  
(Thessaloniki, GR)

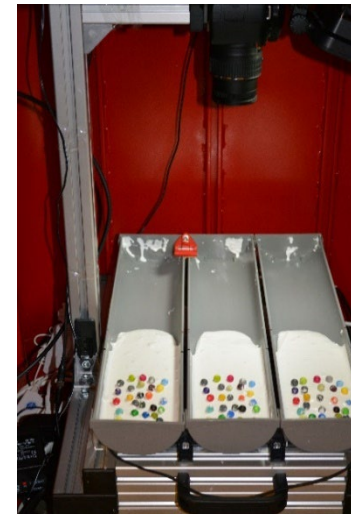

**Planetary/Glacier**  
(Amsterdam, NL)



5 camera's

**Bubble Generation**  
(Thessaloniki, GR)

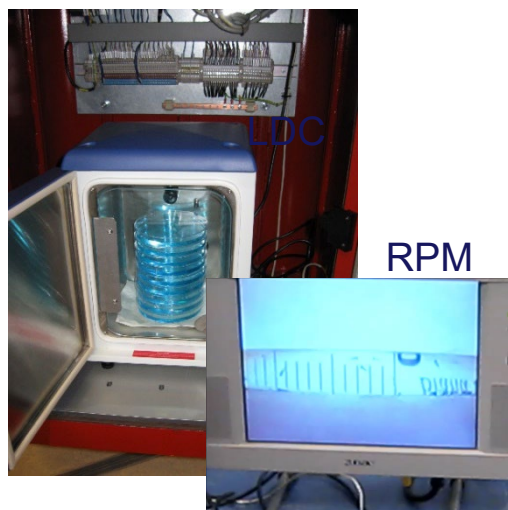

(Liege, BE)

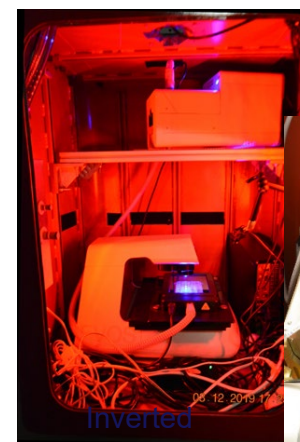

EVOS M7000

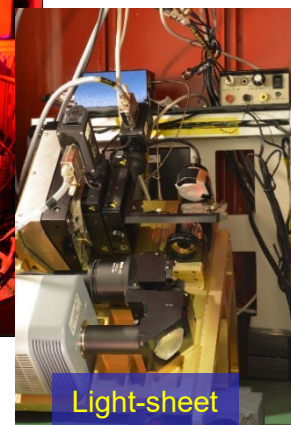

Light-sheet

**Fluorescence Mics** light sheet

# The HyperGES Proposal : what should be clearly addressed?!

## Why to use the LDC?

- Use LDC for 'regular' hypergravity studies / launch simulations / low gravity extrapolations / microgravity simulations (Reduced Gravity Paradigm)
- Science / application background / rationale (Preliminary data (own / from literature) / References! ...)
- Duration of the experiment (max. 2 weeks)

## How to use the LDC?

- Identify what parameters to measure and how (either on-line or post exposure) – Expected outcome
- Show a (preliminary) hardware configuration
- Think about schedule / logistics
- How to communicate your results (report / peer reviewed science paper / conference presentation, local and social media .....

## Before upload.....

- (Re-)check if ALL parts of the proposal are completed
- .....

# Some peer reviewed papers from previous LDC studies (non-exhaustive list) on general, **cell biology**, **plant biology**, **animal physiology**, **fluid physics**, **plasma physics**, **geology/planetary**, **technology**, **material sciences** and other topics:

## Centrifuges general topics / background

- [doi:10.3389/fspas.2016.00021](https://doi.org/10.3389/fspas.2016.00021)
- [doi: 10.3389/frspt.2020.00003.](https://doi.org/10.3389/frspt.2020.00003)
- [DOI 10.1007/s12217-015-9462-9](https://doi.org/10.1007/s12217-015-9462-9)

## Fluid physics

- <https://link.aps.org/doi/10.1103/PhysRevLett.123.244501>
- [doi:10.1007/s12217-019-09740-8.](https://doi.org/10.1007/s12217-019-09740-8)
- [doi.org/10.1016/j.ijmultiphaseflow.2019.03.029.](https://doi.org/10.1016/j.ijmultiphaseflow.2019.03.029)
- [DOI: \[doi.org/10.1016/j.ijheatmasstransfer.2018.12.086\]\(https://doi.org/10.1016/j.ijheatmasstransfer.2018.12.086\)](https://doi.org/10.1016/j.ijheatmasstransfer.2018.12.086)
- <https://doi.org/10.1016/j.fbp.2017.02.001>
- <https://doi.org/10.1103/PhysRevE.91.053009>
- [DOI: \[10.1209/0295-5075/110/24001\]\(https://doi.org/10.1209/0295-5075/110/24001\)](https://doi.org/10.1209/0295-5075/110/24001)
- [DOI \[10.1007/s10035-013-0403-2\]\(https://doi.org/10.1007/s10035-013-0403-2\)](https://doi.org/10.1007/s10035-013-0403-2)
- <https://doi.org/10.1016/j.exptthermflusci.2015.01.011>
- [https://doi.org/10.1016/j.foodres.2013.10.044.](https://doi.org/10.1016/j.foodres.2013.10.044)
- <https://doi.org/10.1007/s12217-012-9323-8>

## Cell biology:

- [DOI: \[10.1016/j.ejpb.2021.03.013.\]\(https://doi.org/10.1016/j.ejpb.2021.03.013\)](https://doi.org/10.1016/j.ejpb.2021.03.013)
- [DOI: \[10.1002/jbm.a.37215\]\(https://doi.org/10.1002/jbm.a.37215\)](https://doi.org/10.1002/jbm.a.37215)
- [doi: \[10.1016/j.bpj.2021.01.021\]\(https://doi.org/10.1016/j.bpj.2021.01.021\)](https://doi.org/10.1016/j.bpj.2021.01.021)
- [doi: \[10.3390/ijms21072354.\]\(https://doi.org/10.3390/ijms21072354\)](https://doi.org/10.3390/ijms21072354)
- <https://doi.org/10.1016/j.bpj.2019.03.038>
- [doi: \[10.1089/scd.2017.0206\]\(https://doi.org/10.1089/scd.2017.0206\)](https://doi.org/10.1089/scd.2017.0206)
- [DOI: \[10.1098/rsif.2016.0688.\]\(https://doi.org/10.1098/rsif.2016.0688\)](https://doi.org/10.1098/rsif.2016.0688)
- [doi:\[10.2147/IJN.S76329\]\(https://doi.org/10.2147/IJN.S76329\)](https://doi.org/10.2147/IJN.S76329)
- [DOI: \[10.1371/journal.pone.0144269.\]\(https://doi.org/10.1371/journal.pone.0144269\)](https://doi.org/10.1371/journal.pone.0144269)
- [DOI: \[10.1089/ten.tea.2012.0267\]\(https://doi.org/10.1089/ten.tea.2012.0267\)](https://doi.org/10.1089/ten.tea.2012.0267)
- <https://doi.org/10.1016/j.jbiosc.2011.09.025>

## Plasma physics

- [doi.org/10.1088/1361-6595/aa5ee8.](https://doi.org/10.1088/1361-6595/aa5ee8)
- [doi:10.1088/0963-0252/24/2/022002](https://doi.org/10.1088/0963-0252/24/2/022002)
- <http://dx.doi.org/10.1016/j.materresbull.2014.03.013>
- DOI: [10.1140/epjd/e2013-40408-7](https://doi.org/10.1140/epjd/e2013-40408-7)

## Plant biology

- [doi:10.1038/s41598-018-24942-7.](https://doi.org/10.1038/s41598-018-24942-7)
- <https://doi.org/10.1007/s12217-016-9531-8>
- <http://dx.doi.org/10.3389/fspas.2016.00002>
- [doi:10.1038/srep07730](https://doi.org/10.1038/srep07730)
- <http://dx.doi.org/10.1155/2014/964203>
- [doi:10.1371/journal.pone.0058246](https://doi.org/10.1371/journal.pone.0058246)
- [doi:10.1007/s12217-012-9301-1](https://doi.org/10.1007/s12217-012-9301-1)

## Animal physiology

- doi: [10.1302/2046-3758.102.BJR-2020-0239.R1](https://doi.org/10.1302/2046-3758.102.BJR-2020-0239.R1)
- doi: [10.1038/s41526-020-00115-7](https://doi.org/10.1038/s41526-020-00115-7)
- DOI [10.7717/peerj.6055.](https://doi.org/10.7717/peerj.6055)
- <https://doi.org/10.3390/ijms20030720>
- DOI:10.1371/journal.pone.0126928
- DOI: [10.1155/2014/679672.](https://doi.org/10.1155/2014/679672)
- DOI [10.1007/s12217-012-9334-5](https://doi.org/10.1007/s12217-012-9334-5)

## Geology/planetary

- doi: [10.1098/rspa.2016.0673](https://doi.org/10.1098/rspa.2016.0673)

## Technology

- doi: [10.1016/j.bpj.2021.01.021](https://doi.org/10.1016/j.bpj.2021.01.021)
- DOI: [10.1002/adv.21937](https://doi.org/10.1002/adv.21937)
- ISBN [978-1-68108-499-2](https://doi.org/10.1007/978-1-68108-499-2)

## Material sciences

- DOI: <https://doi.org/10.1016/j.ijheatmasstransfer.2018.05.151>

# Any question / remarks?!

## Don't wait asking !!

Jack van Loon:

[j.vanloon@amsterdamumc.nl](mailto:j.vanloon@amsterdamumc.nl)

+ 31 653700944 (mobile)

TEC-MMG LIS Lab web URL:

[http://m.esa.int/Our\\_Activities/Space\\_Engineering\\_Technology/Life\\_Physical\\_Sciences\\_and\\_Life\\_Support\\_Laboratory](http://m.esa.int/Our_Activities/Space_Engineering_Technology/Life_Physical_Sciences_and_Life_Support_Laboratory)