

KiboCUBE Academy

Lecture 12

Introduction to Nano-Satellite Mechanisms

Tokyo Institute of Technology, Japan

Department of Mechanical Engineering

Associate Professor Hiraku SAKAMOTO, Ph.D.

This lecture is NOT specifically about KiboCUBE and covers GENERAL engineering topics of space development and utilization for CubeSats.

The specific information and requirements for applying to KiboCUBE can be found at:
<https://www.unoosa.org/oosa/en/ourwork/psa/hsti/kibocube.html>



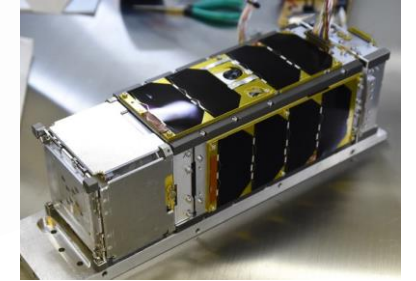
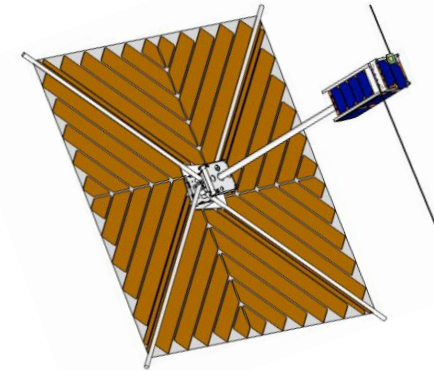
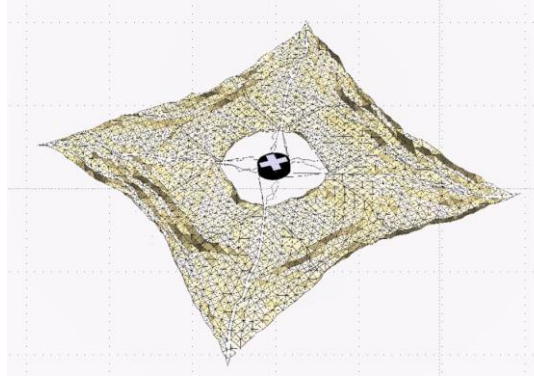

Hiraku SAKAMOTO, Ph.D.

Position:

2015 - Associate Professor

Department of Mechanical Engineering, Tokyo Institute of Technology, Japan.

2015 - Board Member, University Space Engineering Consortium Japan (UNISEC)

2015-2019 Principal Investigator, 3U CubeSat OrigamiSat-1/FO-98

Research Topics:

Space deployable structures, Systems engineering for small spacecraft development and utilization

1. Introduction
2. Important Topics in Nano-Satellite Mechanisms
3. Elements of Mechanisms
4. Development Example 1: Deployment switch on CubeSat
5. Development Example 2: Deployable solar panels
6. Development Example 3: Deployable membrane
7. Conclusion



1. Introduction

1. Introduction

1.1 Introduction to nano-satellite mechanisms

Structure Engineers' mind

Systems Engineering

Magnetization
Grounding for avionics

Thermal balance
Thermal deformation
Alignment stability

Rocket interface
- Mechanical
- Electrical

Debris protection
Radiation protection

Buckling
$$F = \frac{\pi^2 EI}{(KL)^2}$$



Dynamic stiffness
- Resonance

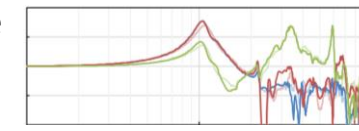

System integration and test

Bending deformation
$$M = -EI \frac{d^2 w}{dx^2}$$

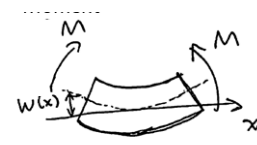

Mass vs Strength/Stiffness

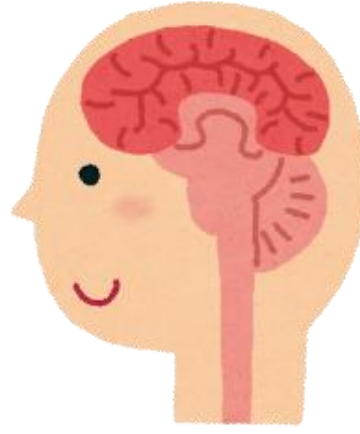

Component assembly
- Accessibility
- Tools

Yield strength
$$\sigma = E\epsilon$$

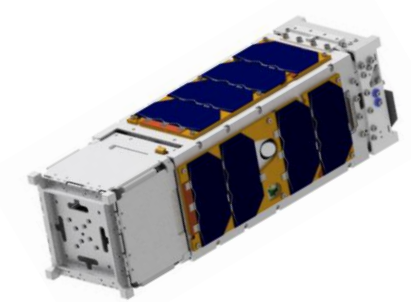
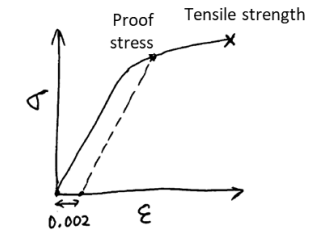

Material
- Ease of **manufacture**
- Erosion by atomic oxygen

Design verification
- Analysis (FEM)
- Test

1. Introduction

1.1 Introduction to nano-satellite mechanisms

Mechanisms are onboard devices whose function is based around mechanical movement.

Structure Engineers' mind

Systems Engineering

Debris protection
Radiation protection

Magnetization
Grounding for avionics

Thermal balance

Thermal deformation
Alignment stability

Rocket interface

- Mechanical
- Electrical

System integration and test

Component assembly

- Accessibility
- Tools

Design verification

- Analysis (FEM)
- Test

Bending deformation

$$M = -EI \frac{d^2w}{dx^2}$$



Buckling

$$F = \frac{\pi^2 EI}{(KL)^2}$$



Dynamic stiffness

- Resonance

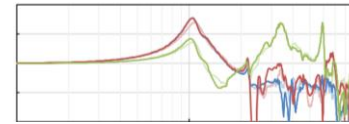

Mass vs Strength/Stiffness

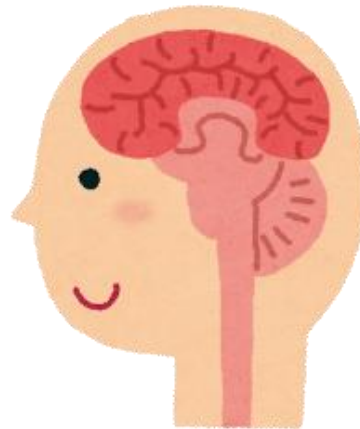

Yield strength

$$\sigma = E\epsilon$$

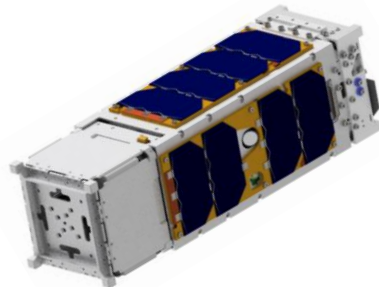
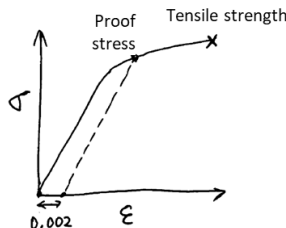

Material

- Ease of **manufacture**
- Erosion by atomic oxygen

1. Introduction

1.1 Introduction to nano-satellite mechanisms (2/2)

What you take away from this lecture:

- How mechanisms are developed and used in nanosatellite lifecycles.
- Common elements of mechanisms.
- **Lessons learned** during development of **3 mechanisms** in actual projects.

(2) Deployable solar panel



Hodoyoshi 3



Hodoyoshi 4

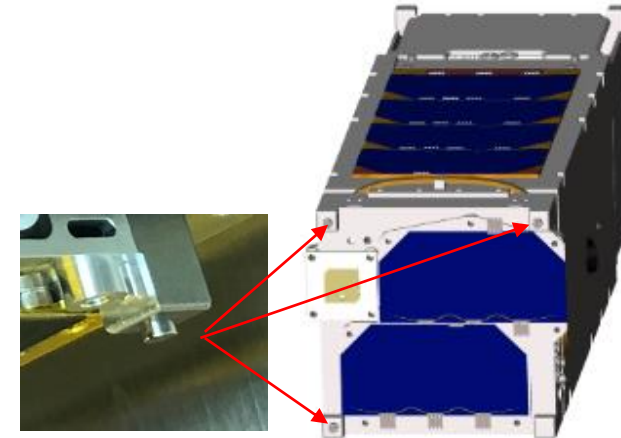

3U CubeSat OrigamiSat-1

(1) Deployment detection switch



(3) Deployable membrane

1. Introduction

1.2 Mechanisms in a satellites' lifecycle (1/3)

Typical mission lifecycle

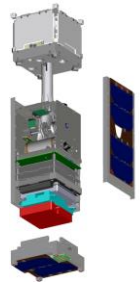
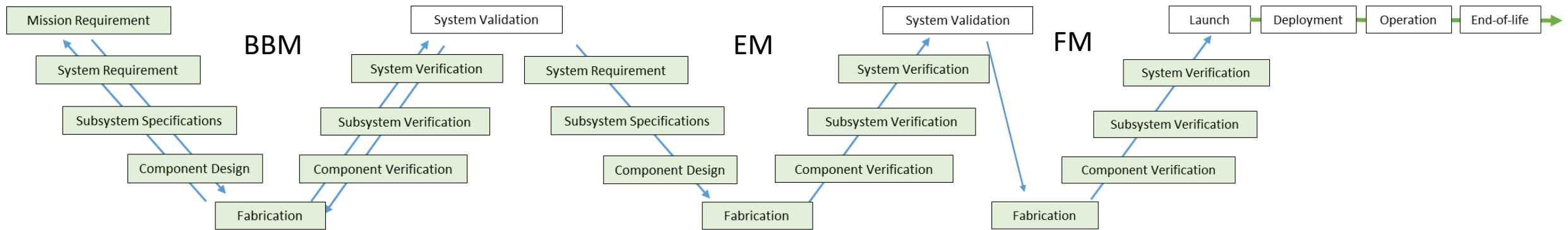

- ✓ CAD drawing
- ✓ Mock-up

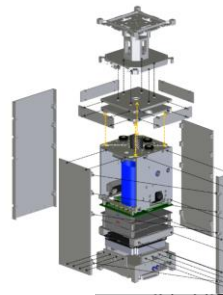
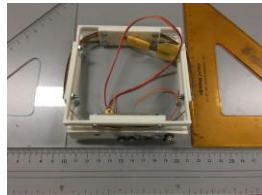
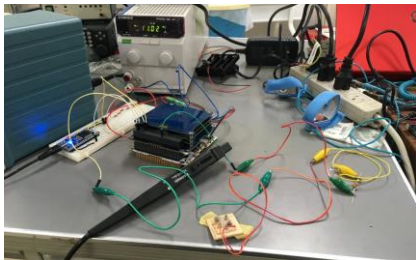

- ✓ Machining drawing
- ✓ Structural analysis
- ✓ EM structure

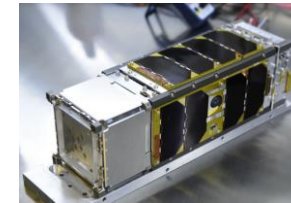
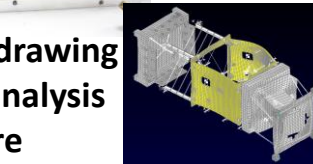
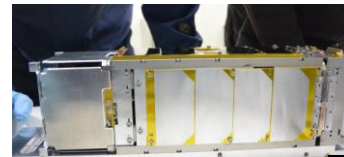
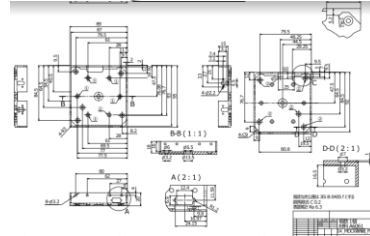

- ✓ FM

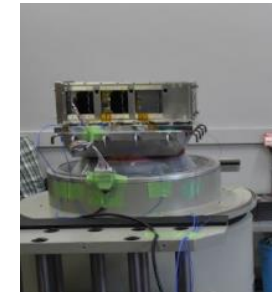

1. Introduction

1.2 Mechanisms in a satellites' lifecycle (2/3) **Typical loads during a lifecycle**

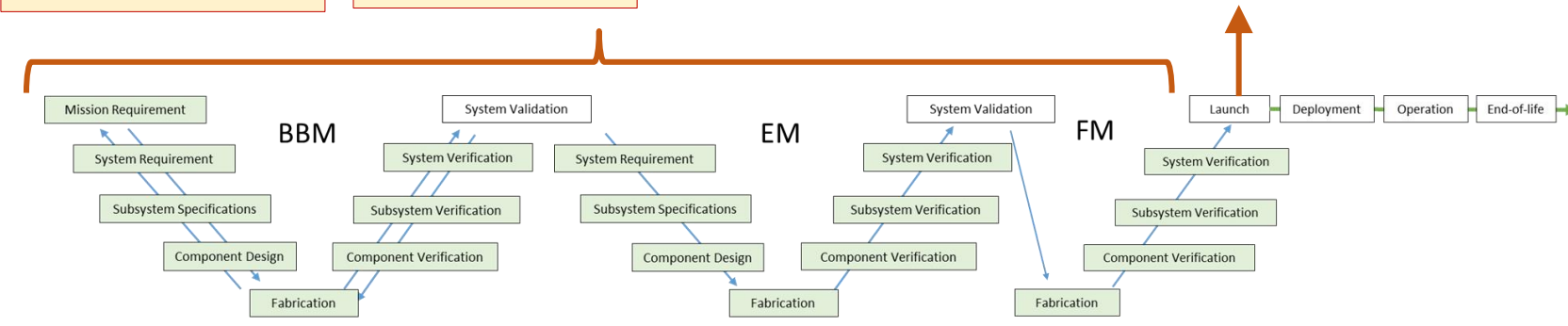
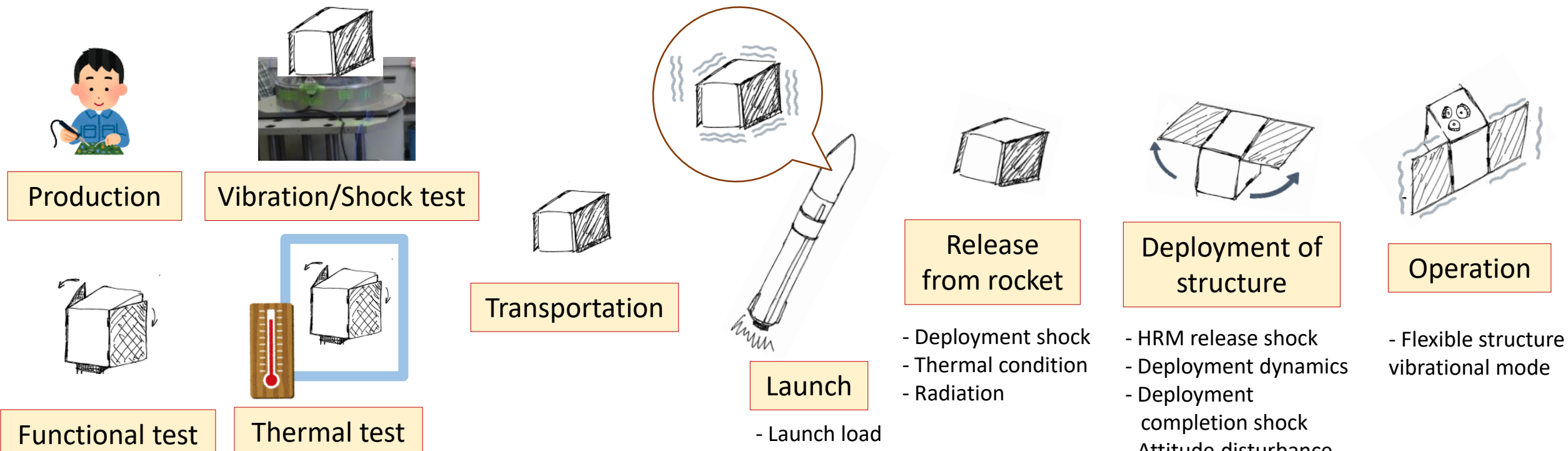

1. Introduction

1.2 Mechanisms in a satellites' lifecycle (3/3) **Typical Natural frequencies in a lifecycle**

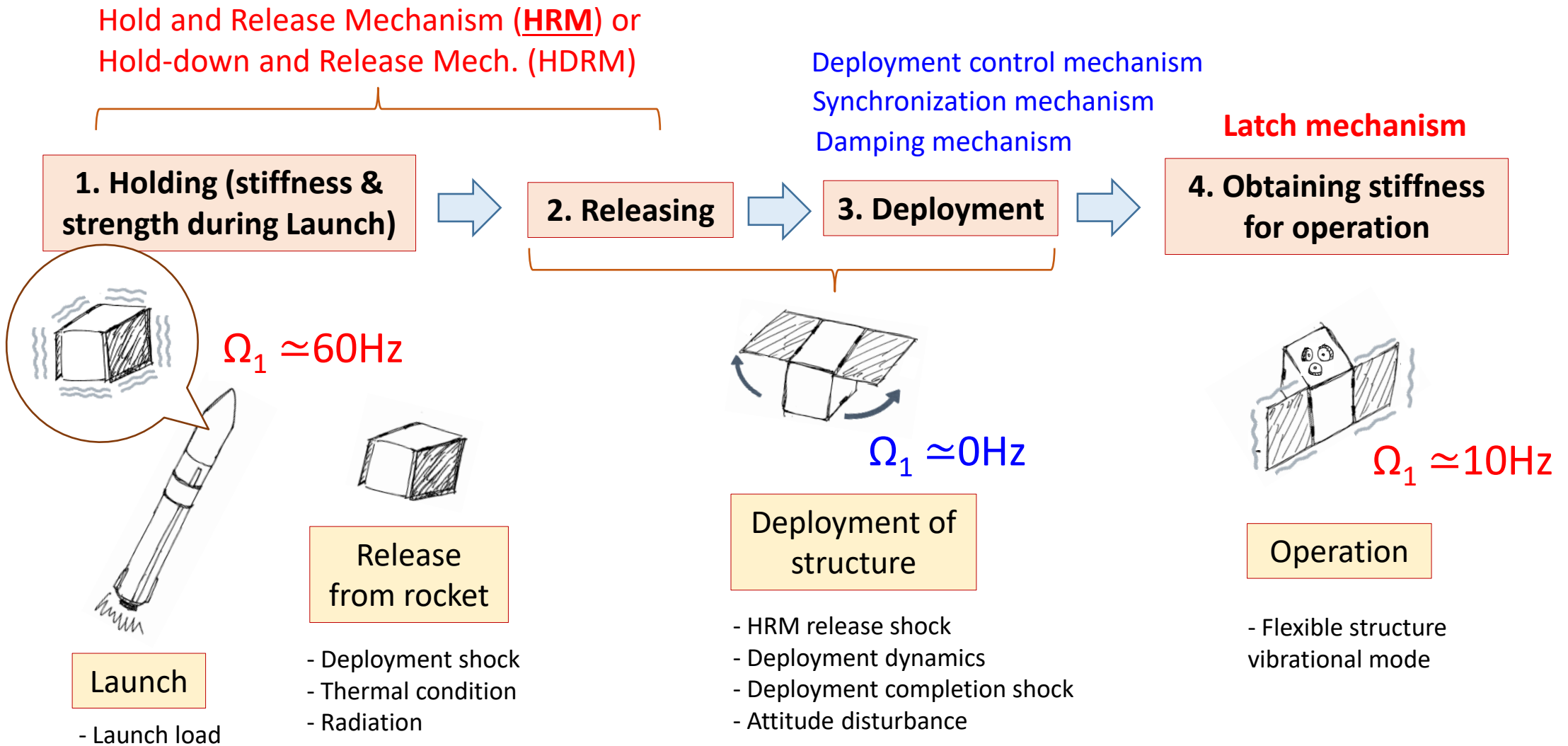

1. Introduction

1.3 Design process (1/2)

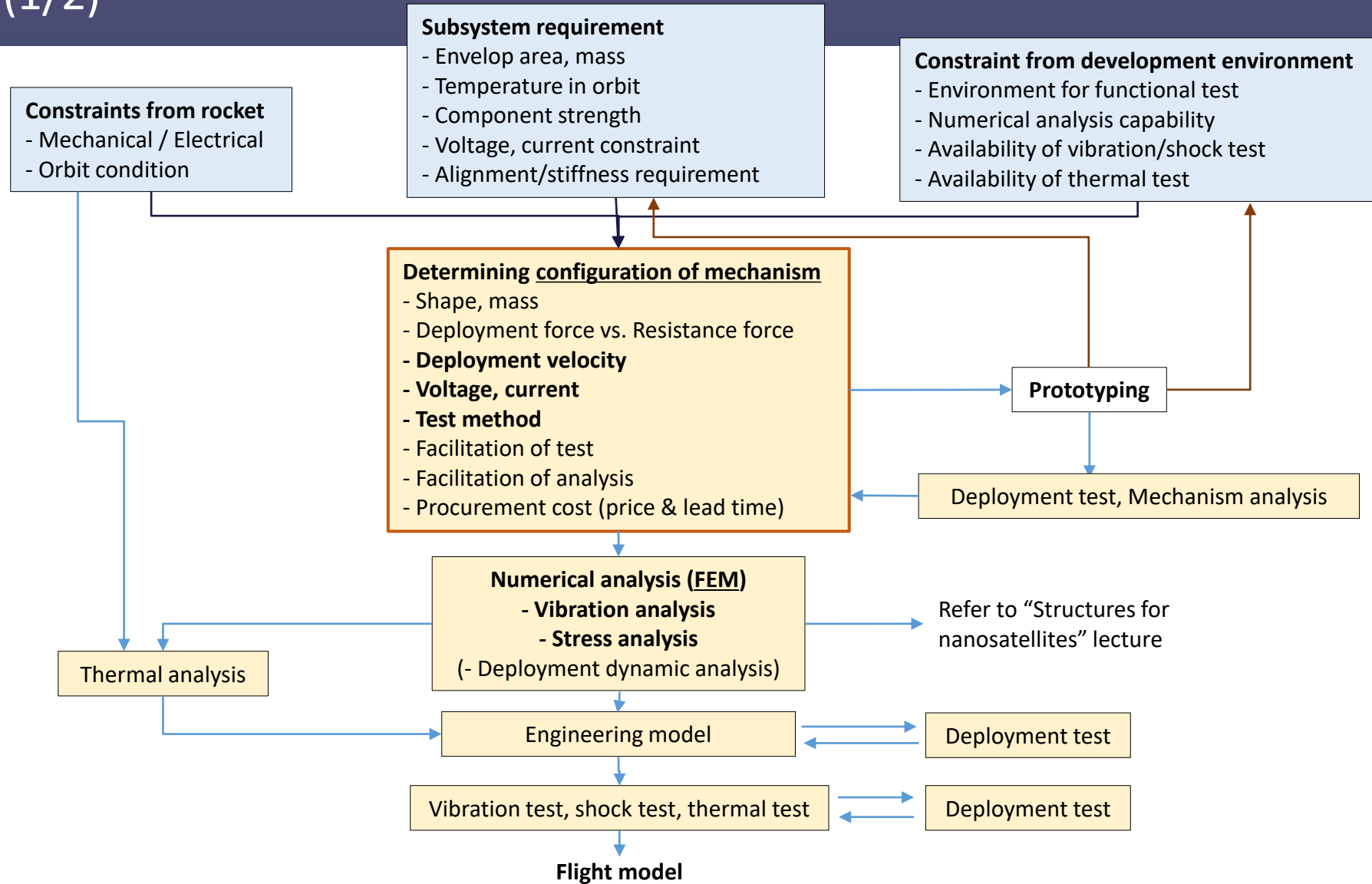

1. Introduction

1.3 Design process (2/2)

Clarify deployment assistance force vs. resistance force

- List factors of assisting force/torque and resisting force/torque. Then, estimate each magnitude.
 - ✓ Used for planning and evaluation of analysis and tests.
 - ✓ Watch out for effects of temperature (thermal deformation, friction).
 - ✓ Also watch out for nonlinearity of assistance/resistance forces. They may vary from the beginning to the end of deployment.

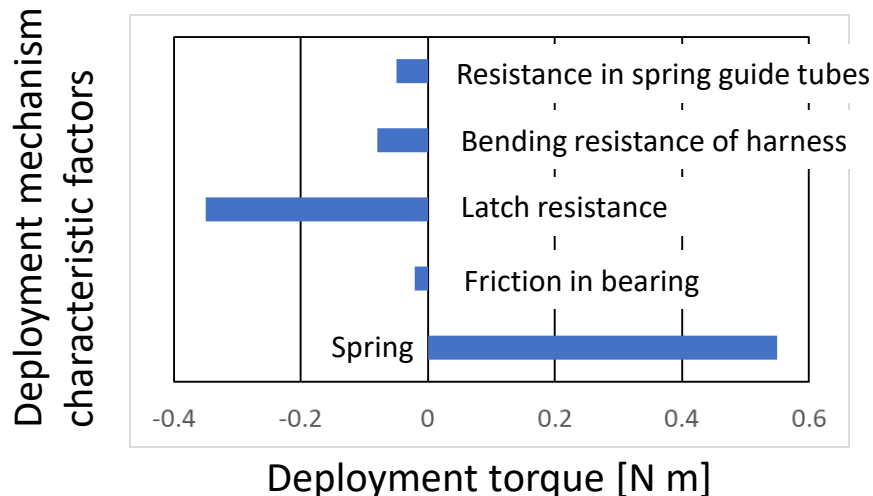

Example: Torque in flip-up mechanism of 3.5m reflector for communication on ETS-VI satellite (at low temperature) [1]

[1] Japan Society of Mechanical Engineers (JSME) (ed.), *Mechanical Engineering Handbook: Space Equipment and Systems (Applied Systems Edition v11)*, 2007. (in Japanese)



2. Important Topics in Nanosatellite Mechanisms

2. Important Topics in Nanosatellite Mechanisms

2.1 Launch loads

Launch loads: often categorized into four types with different frequency domains.

(1) Quasi-static acceleration load:

- The acceleration in the direction of flight caused by an engine's thrust (about 10G).

(2) Sine vibration load:

- Caused by rocket vibration with a large peak at 10 to 30 Hz, under 100Hz.

(3) Random vibration load = acoustic load:

- The acoustic vibrations from the engine jets are propagated from the mechanical interface.
- Additionally, in the atmosphere, acoustic loads are applied directly through the fairing.

(4) Shock load:

- Shocks caused by explosions of pyrotechnics and separation of spacecraft.

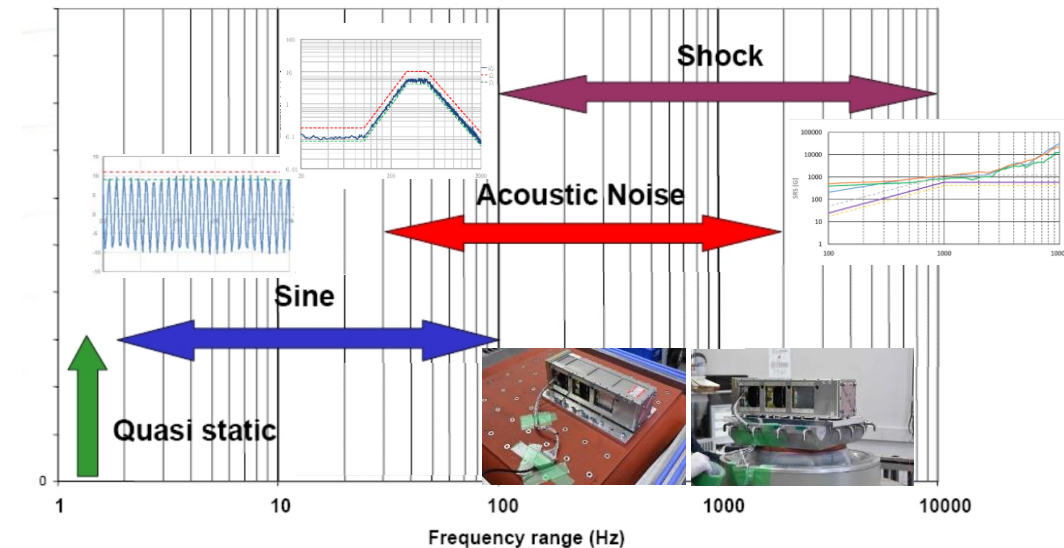

Appendix: Slide from Prof. Kuwahara's lecture

Launch Conditions of KiboCUBE's Launch Vehicles

- Random vibration condition

Random vibration conditions of launch vehicles

HTV-X		Dragon		Cygnus	
Freq. (Hz)	PSD (g^2/Hz)	Freq. (Hz)	PSD (g^2/Hz)	Freq. (Hz)	PSD (g^2/Hz)
20	0.005	20	0.02	20	0.004
50	0.02	200	0.02	30	0.004
120	0.031	2000	0.001	70	0.015
230	0.031			150	0.015
1000	0.0045			2000	0.0006
2000	0.0013				
Overall (grms)	4.05	Overall (grms)	3.2	Overall (grms)	2.44
Duration (sec)	60	Duration (sec)	60	Duration (sec)	60

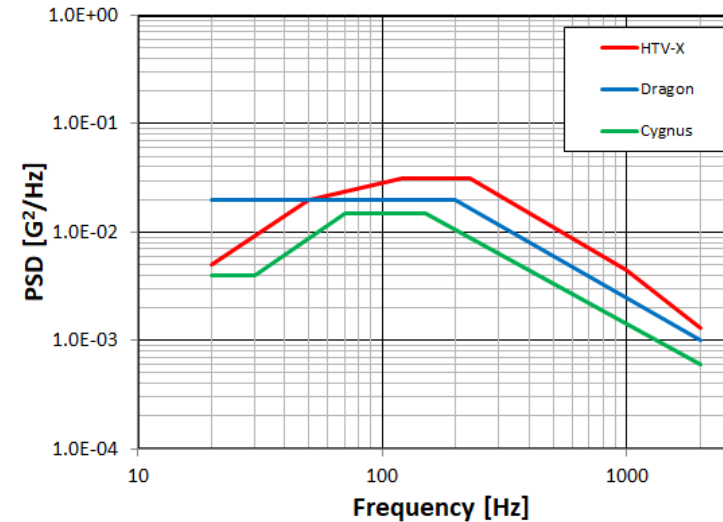

- Quasi-static acceleration condition

- HTV-X: 6.0 [g]
- SpaceX Dragon: 9.0 [g]
- Orbital Cygnus: 9.0 [g]

- Shock condition

- N/A

Reference: JEM Payload Accommodation Handbook Vol. 8 D (Japanese)
https://iss.jaxa.jp/kibouser/library/item/jx-espac_8d.pdf

2. Important Topics in Nanosatellite Mechanisms

2.2 Tribology (1/2)

Tribology: Tribology is the science and engineering of interacting surfaces in relative motion, including lubrication, friction, wear, galling, and bearing design.

The high vacuum environment in space has the following effects on sliding parts of a mechanism.

■ **Evaporation of lubricants:** In low pressure, even solid state lubricants evaporate. Evaporation should be considered, especially for liquid lubricants such as oil and grease.

⇒ Selection of appropriate lubrication method is important.

■ **Cold welding:** Metal surfaces stick together due to an increase in the friction coefficient. This is caused by delays in the formation of molecular absorption layer/oxidized layer (protective layer = low friction).

✓ After the protective layer is worn off on a metal contact surface due to launch vibrations, etc. (=fretting wear), in the air, oxidation occurs quickly and the protective layer is repaired.

✓ In contrast, in a vacuum, repair is slow and the worn surfaces touch each other, resulting in high friction.

⇒ See the next page for countermeasures.

2. Important Topics in Nanosatellite Mechanisms

2.2 Tribology (2/2)

Countermeasures for Cold Welding [2]:

1. One of the two contacting surfaces may be made of a polymer material; a polymer material with high rigidity and strength such as PEEK (polyetheretherketone) resin is often used.
2. If a different alloy is used for contacting surfaces, we have less cold welding effects.
3. Hard anodizing treatment is applied to aluminum surfaces to produce a hard surface layer. (This is required for CubeSats rails.)
4. Use molybdenum disulfide (MoS_2) on contact surfaces as a solid lubricant.
 - It is the most widely used lubrication method in space. It has good thermal stability.
 - However, be careful of wear caused by vibration loads (fretting wear).
 - Note that lubrication properties degrade due to moisture absorption in the air.

[2] A. Merstallinger, et al., "Assessment of Cold Welding between Separable Contact Surfaces due to Impacts and Fretting under Vacuum," STM-279, European Space Agency, 2009.

2. Important Topics in Nanosatellite Mechanisms

2.3 Other space environment effects

■ Atomic Oxygen (AO)

AO exists in low orbits. Many polymer materials are strongly oxidized by AO, resulting in gradual loss of material surface (**erosion**). [3]

- ✓ Polyimide and CFRP, which are often used as space materials, are also subjected to erosion by AO.
- ✓ Special attention should be paid to deployment mechanisms such as solar panels, since they are **exposed in space**, outside of satellite structures.

■ Ultraviolet wave (UV), space radiation

- ✓ Typically UV radiation causes photooxidative degradation which results in **breaking of polymer chains**, and reduces the molecular weight, causing deterioration of mechanical properties.

■ Thermal environment

- ✓ Note that thermal deformation can cause **fatigue**; in addition, it can **change alignment of mechanisms** causing higher friction.

[3] Kimoto, et al., "Atomic Oxygen Effects on Space Materials in Low Earth Orbit and Its Ground Evaluation," Journal of the Vacuum Society of Japan, Vol. 52, No. 9, 2009 (in Japanese)

2. Important Topics in Nanosatellite Mechanisms

2.4 Verification methods (1/3)

(1) Gravity compensation system for ground tests

Deployment behavior of deployment structures is greatly affected by gravity and atmosphere; Offloading methods are required to better reproduce deployment assistance force/torque and resistance force/torque.

- ✓ **Gravity effect on gaps:** Movable mechanisms usually have some **gap**. But on the ground, parts are **pushed vertically downward** due to gravity. This pushing is not present in microgravity.
- ✓ **Geometrical stiffness:** Deployment structure is often flexible. It is stiffer on ground than in microgravity due to stiffening caused by its own weight.
- ✓ **Deflection due to gravity:** During and after deployment, gravity compensation (gravity cancellation, gravity offloading) is often used to avoid large deformations due to own weight. [4]
 - Hanging from a high ceiling with threads
 - Air bearing, airfield hockey table
 - Floating on water, sinking in water
 - Wheels, etc.

+ **Air drag:** In the case of dynamic deployment, the deployment **speed is reduced** on ground due to atmospheric drag.

⇒ Design a simple ground experiment method simultaneously.

[3] J. Banik et al, *Testing Large Ultra-Lightweight Spacecraft*, American Institute of Aeronautics and Astronautics, 2017, Chapter 3.



2. Important Topics in Nanosatellite Mechanisms

2.4 Verification methods (2/3)

(2) Numerical analysis

- **FEM (linear modeling):** Vibration and stress analysis are carried out to evaluate **stiffness** and **strength** by the Finite-Element Method (FEM). (See “Structure” lecture)
- **Dynamic transient analysis**
 - ✓ The equation of motion is calculated with advancing time by Δt from initial conditions. In each time step, the equilibrium of stress and displacement is calculated.
 - The equation of motion is a differential equation; thus the equation is **integrated with respect to time**.
 - ✓ Transient response analysis is used when nonlinearity is high and it is difficult to evaluate only with linear vibration mode analysis.



Example of dynamic transient analysis for small solar power sail demonstrator IKAROS (contingency deployment)

(Sakamoto, et al., AIAA 2011-1892)

2. Important Topics in Nanosatellite Mechanisms

2.4 Verification methods (3/3)

- **Geometrically nonlinear FEM**

- ✓ The common Finite Element Method (FEM) analysis is "linear analysis".

This model assumes that stiffness of a structure (e.g. EI) does not change between the undeformed state and the deformed state.

- This is well applicable for small deformations of stiff structure.

- ✓ However, when we consider out-of-plane deformation of a thin plate, the out-of-plane stiffness changes due to in-plane tension and compression.

- ✓ In other words, a structure with stiffness K_0 in an **undeformed state** changes its stiffness to

$$K_0 + K_g(x_i)$$

in a **deformed state** due to change of stress distribution.

- The second term is called **geometric stiffness**.

- ✓ To consider the geometric stiffness in the FEM, the load is gradually increased and the stiffness value is updated in every step.

- Stiffness at each step is called "**tangential stiffness**."

- Equilibrium displacement is calculated by using "tangential stiffness".

- ✓ This is called the "**geometrically nonlinear FEM**" and can be implemented with commercially available FEM software.

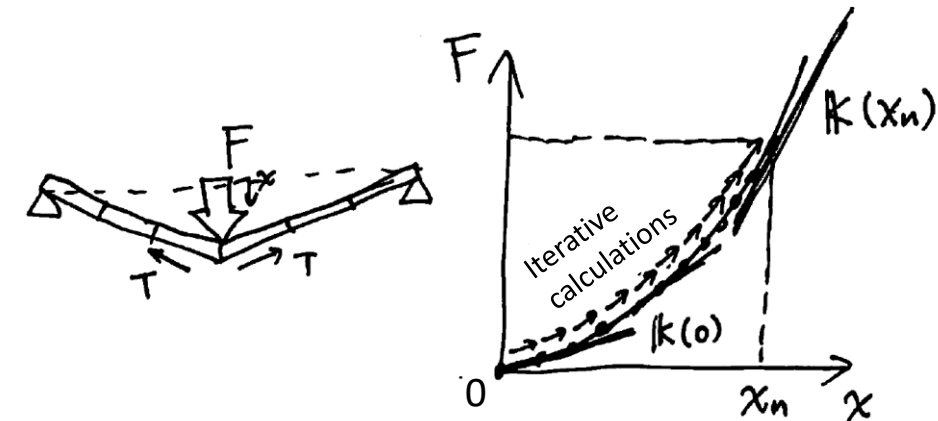
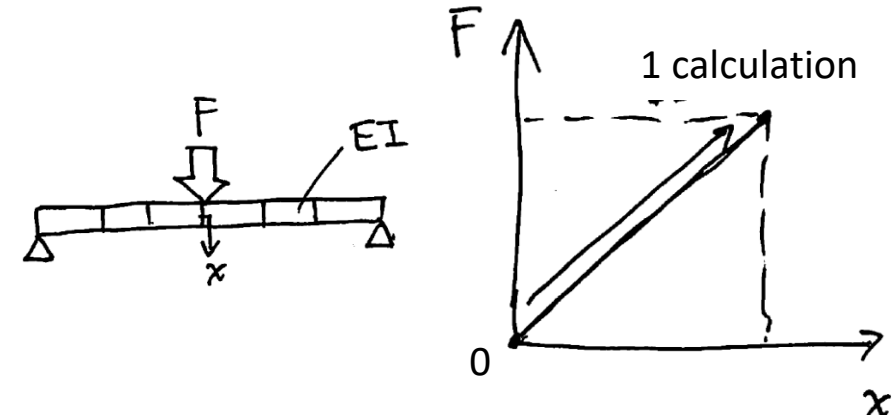

2. Important Topics in Nanosatellite Mechanisms

2.5 Control-Structure interaction

- After the deployable structure is deployed in orbit, the natural frequency is usually low (*i.e.*, **stiffness is low**).
- Due to attitude control actuators, such as reaction wheels (RW), **flexible deployed structures may vibrate**
- If a flexible structure vibrates in a satellite that requires accurate attitude **control**, the **attitude stability will be poor**.
- **Therefore**, generally attitude control actuators are driven with input signals that contain sufficiently lower frequency components than lowest natural frequency of the flexible structure.
- Vibration amplitude (and attitude stability) can be estimated by the following method.
 1. Vibration modes of flexible structures with a fixed satellite attitude are predicted by the FEM and/or experiments for several lowest vibration modes ("**constrained mode**").
 2. The "**Unconstrained mode**" is constructed by combining the "**constrained mode**" into the dynamics of a satellite system, and attitude control is simulated.

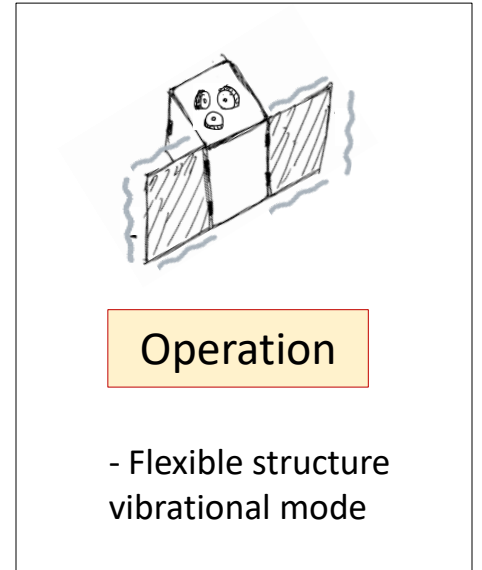



3. Elements of Mechanisms

3. Elements of Mechanisms

3.1 Non-metal lock wire (1/5)

Very commonly used for various HRM on nanosatellites.

Example: Convex deployment antenna of OrigamiSat-1

- ✓ Wrap the two phosphor bronze convex-tape antennas around the satellite structure.
- ✓ The shorter antenna (430 MHz) is wrapped first, and then the longer antenna (145 MHz) is wrapped on top of it.
- ✓ Restrain the tip of the 145MHz antenna with Vectran® threads, fixed to the satellite body.
- ✓ Burn the threads with nichrome wires.

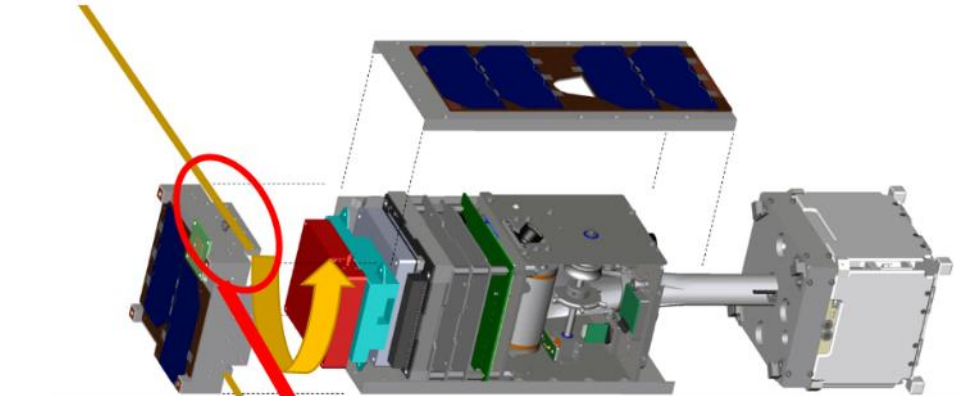

Stored configuration

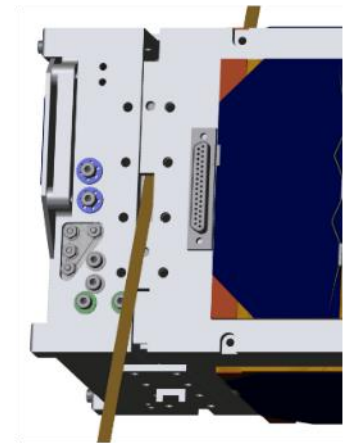

Deployed configuration

3. Elements of Mechanisms

3.1 Non-metal lock wire (2/5)

Example: Convex deployment antenna of OrigamiSat-1

Placement of the threads and Nichrome wires (1/2)

- ✓ Tie two strands of threads (**Vectran® sewing thread #40**) to the hole at the tip of the 145MHz antenna using a **bowline knot**.
- ✓ Put polyimide tape to the antenna tip hole to protect the thread.
- ✓ Tie the thread to the hole around the bobbin using a bowline knot. Then, wrap the thread around the bobbin and reel in it.
- **Tension control method:** Adjust the length of thread by using a mark on the thread. In addition, use a mark on the antenna to make sure that the looseness of the antenna is within the prescribed value that will not interfere with the satellite release.
- **Prevention of bobbins from rotating:** Fasten the screw of the bobbin using a torque driver, and also tighten the two bobbins with #30 stainless steel wire.

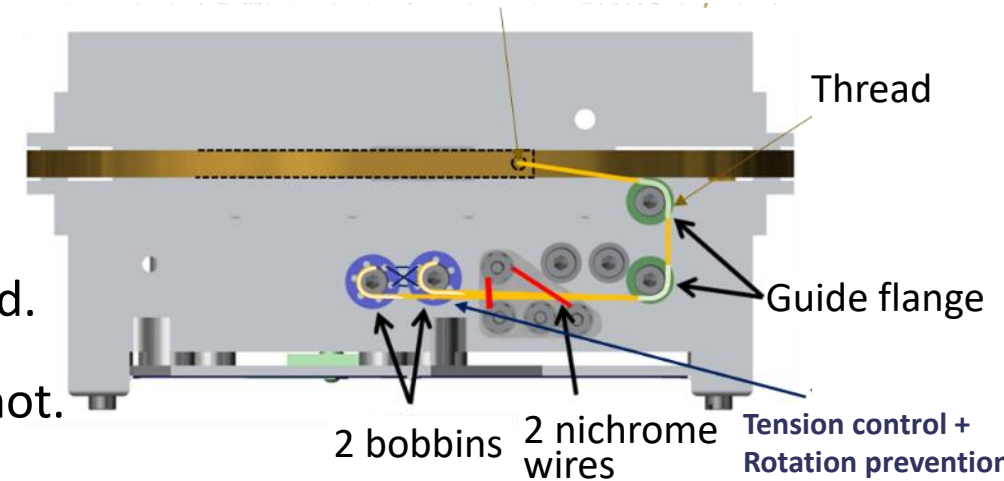

Stored configuration

3. Elements of Mechanisms

3.1 Non-metal lock wire (3/5)

Example: Convex deployment antenna of OrigamiSat-1

Placement of the threads and Nichrome wires (2/2)

- ✓ Pass two threads through the "thread wrapping part" shown in the figure. (The lightly colored parts of the threads are hidden by the flange.)
 - The flange constraints threads to move in the out-of-plane direction.
- ✓ Make sure both threads touch the 2 nichrome wires.

Wind thread around the "thread wrapping part".

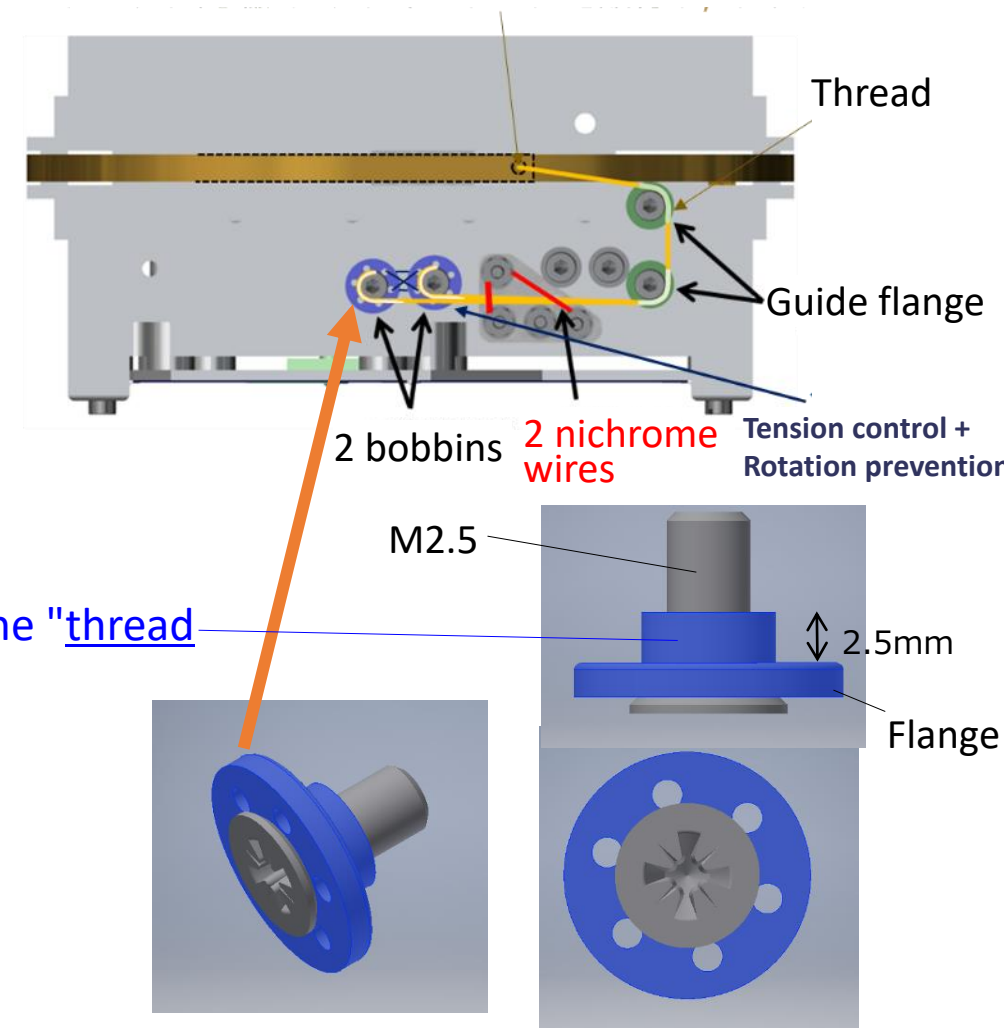

3. Elements of Mechanisms

3.1 Non-metal lock wire (4/5)

Example: Convex deployment antenna of OrigamiSat-1

✓ Measurement of the range of tension

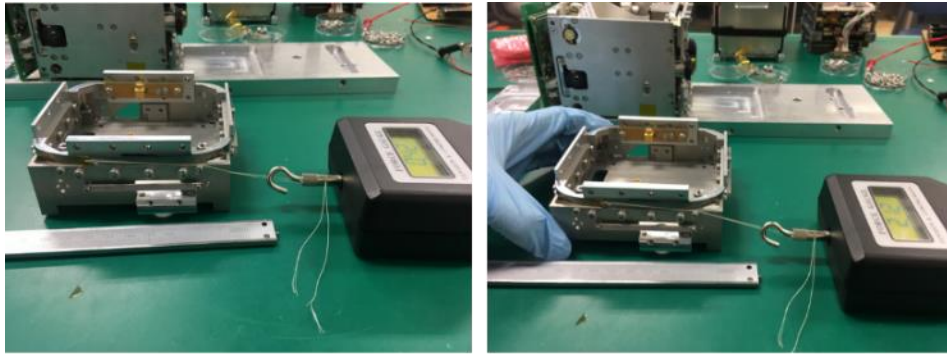

Minimum tension 0.42N

Maximum tension 2.12N

✓ Measurement of the tensile strength

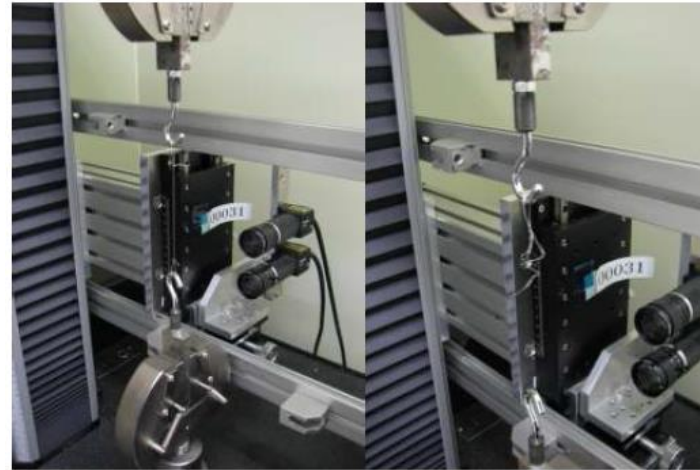

✓ Stretch out until saturation of elongation



✓ 引張試験機で結び目の強度を評価

✓ 長期間荷重をかけクリープ変形を定量化
KiboCUBE Academy

3. Elements of Mechanisms

3.1 Non-metal lock wire (5/5)

Typical checklist for non-metal lock wire system

- Evaluate the safety factor (strength) of the thread in tension. In the case of excessive tension,
 - Use a lever mechanism to generate a large holding force with the smaller thread tension.
 - When increasing the number of threads, make sure that tension is applied evenly.
- Evaluate the thread's change in length due to creep deformation.
- Choose a proper knotting method. Make a procedure manual to ensure knotting repeatability.
- Stretch out the threads (and knots) until saturation. After making knots, apply force to stretch the threads before use.
- Evaluate the strength of the **knot**. Evaluate the strength of the knotted threads, as threads will be compressed at knots and lose strength.
- Consider double redundancy.
- Sharp edge removal: To avoid rubbing on sharp edges and losing strength.
- Determine an inspection procedure for the flight model; practice/check it well during development process.

3. Elements of Mechanisms

3.2 Springs / convex tapes (1/2)

Very commonly used actuators combined with HRM.

- ✓ **Force/torque estimation:** When deployed, elastic energy stored in the spring is converted into kinetic energy; thus, the inertial force assists in deployment. But in most satellites, the required force/torque is determined so that the structure can be statically deployed from any position of deploying motion.
- ✓ **Shock load:** When deployment is completed, a shock force is applied by collision with a stopper.
 - The deployment speed may be slower in atmosphere, thus the deployment completion shock may be greater in vacuum.

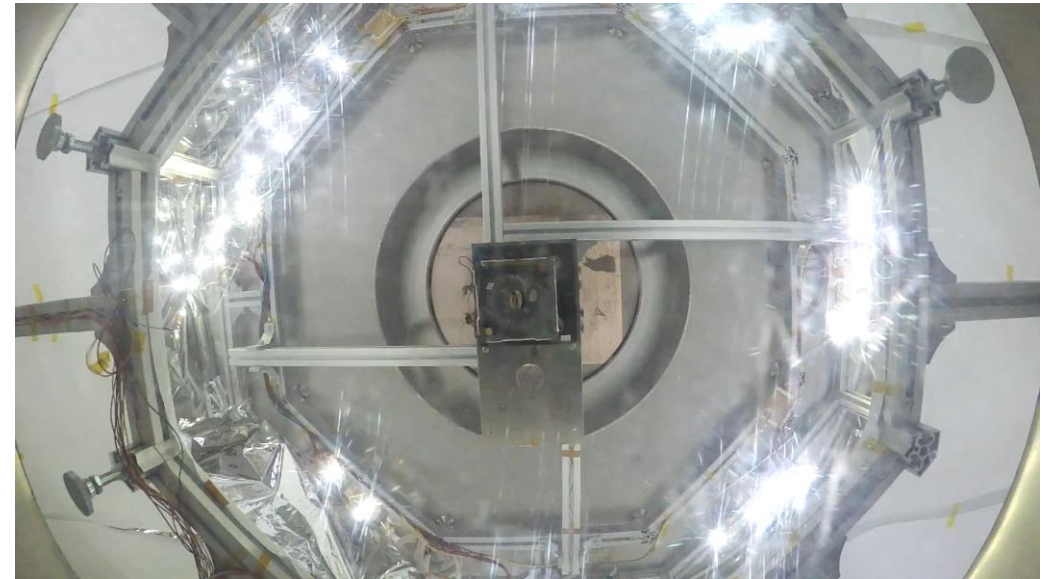

Deployment test of OrigamiSat-1's membrane in vacuum chamber

3. Elements of Mechanisms

3.2 Springs / convex tapes (2/2)

Convex Tapes: Hinges and motors have a risk of seizing because of the **sliding motion**.

- ✓ Therefore, elastic deformation of convex tape is often used to eliminate the risk of seizing (a commercially available carpenter's tape measure is often used in nano-satellites).
- ✓ However, since free deployment causes large shock forces when deployment is completed; deployment may be controlled by a motor.

= STEM: Storable Tubular Extendible Member

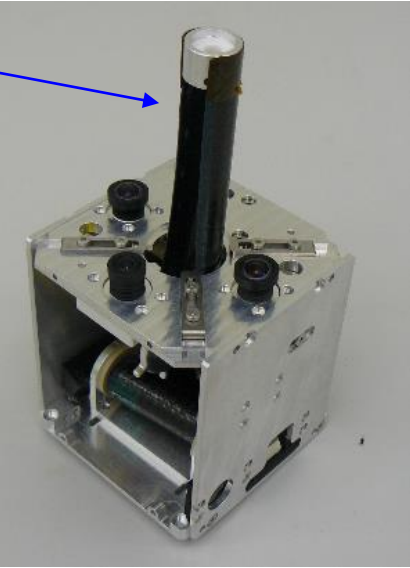
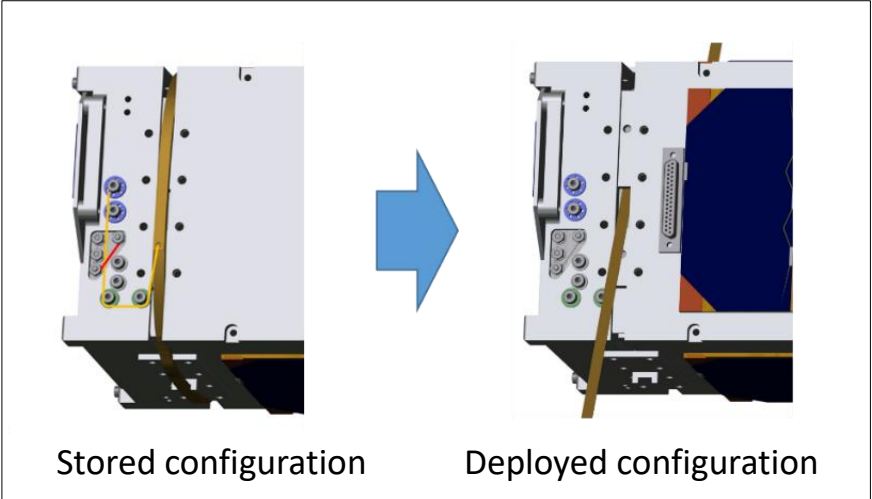

1m Extensible Mast on
3U CubeSat OrigamiSat-1

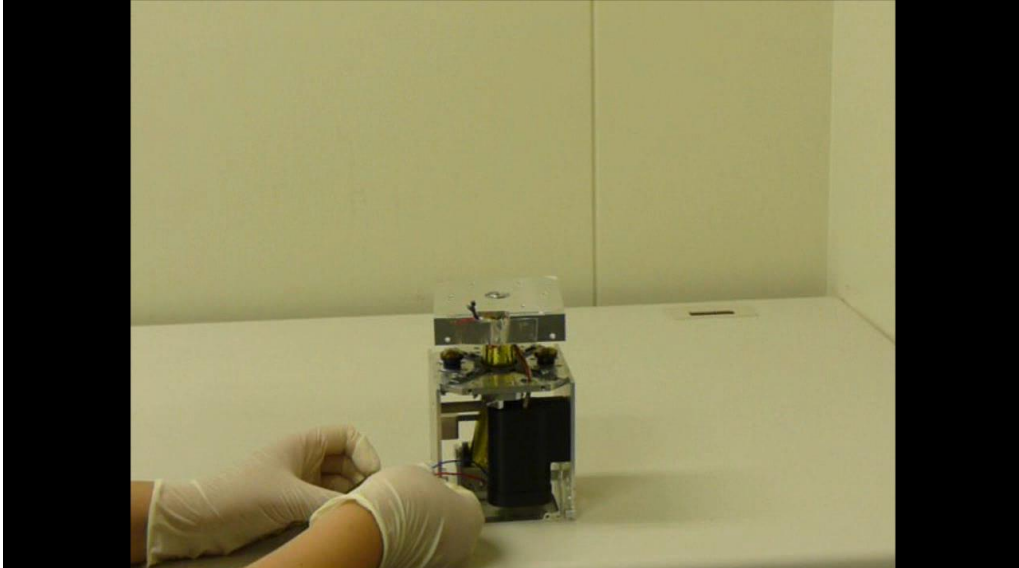

3. Elements of Mechanisms

3.3 Pyrotechnics / non-pyrotechnics

✓ Conventionally, pyrotechnics (pulling out rings, cutting wires, etc. by explosive pressure) were commonly used for satellite and rocket separation because of their high reliability.

➤ They are called separation nuts, separation bolts, wire cutters, etc.

Pyrotechnics are highly reliable, but generate a high shock force. They are also costly because they are often irreversible.

✓ Therefore, in recent years, non-pyrotechnics HRMs are often used.

➤ Flange bolts, pin pullers, and ejectors using shape memory alloys

➤ Paraffin actuators

➔ However, since these are usually preloaded, a relatively large shock load is still generated.



3. Elements of Mechanisms

3.4 Motors / bearings

- ✓ If the inertia of deployed structure is large, or if the deployment shock is a problem, a **motor** can be used for low-speed deployment as it has excellent velocity control.
- ✓ Since a motor is reversible, there is the possibility of including a “**storing**” after “deploying” motion.
- ✓ Generally, **step motors** are used because they are easy to control, but **their torque is low**. Thus, they are usually used with a **reduction gear**.
- ✓ **Motors have temperature limitations.**
 - Because characteristics of internal clearances and bearings change due to temperature change
Therefore, temperature control with a temperature sensor and a heater is often required.
- ✓ Regarding **bearings**, with oil, grease, or solid lubricated ball bearings, plain bearings are available for space applications.

3. Elements of Mechanisms

3.5 Inflatables

✓ "Inflatable" structures deploy by filling a balloon-like membrane with gas. Various missions have demonstrated this in orbit. As a method of gas generation

- Use of compressed gas
- Use of sublimating compound

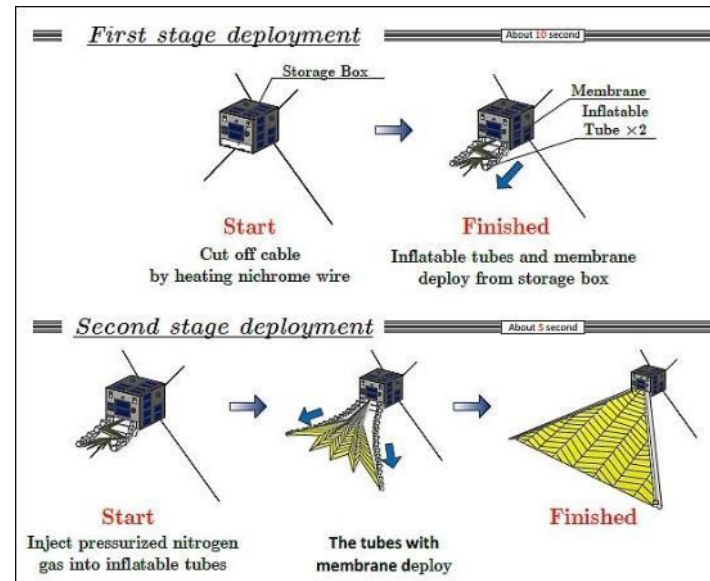
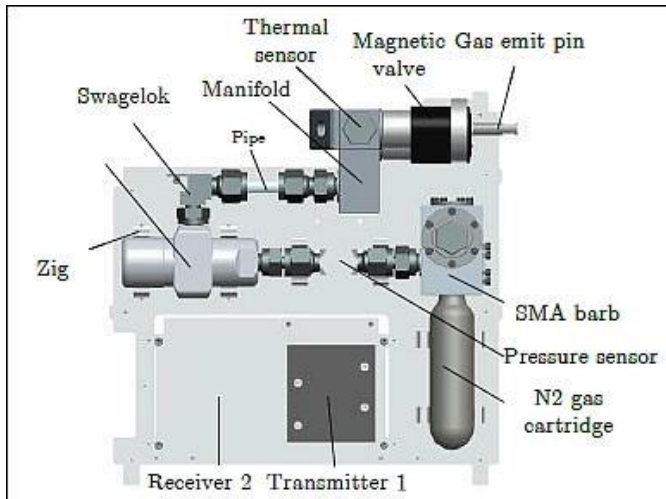
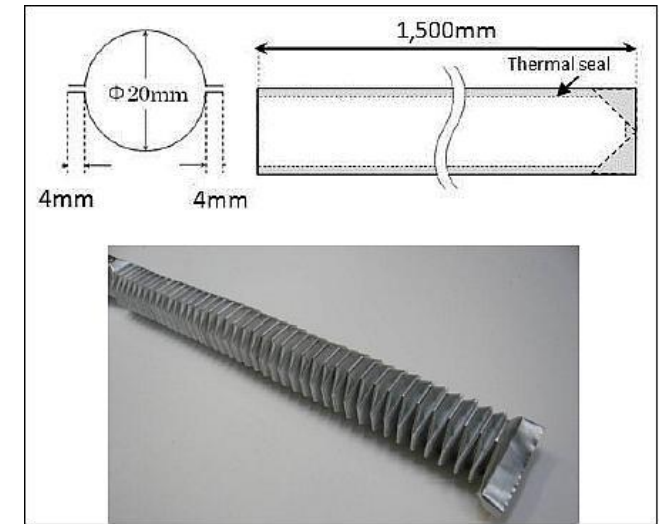
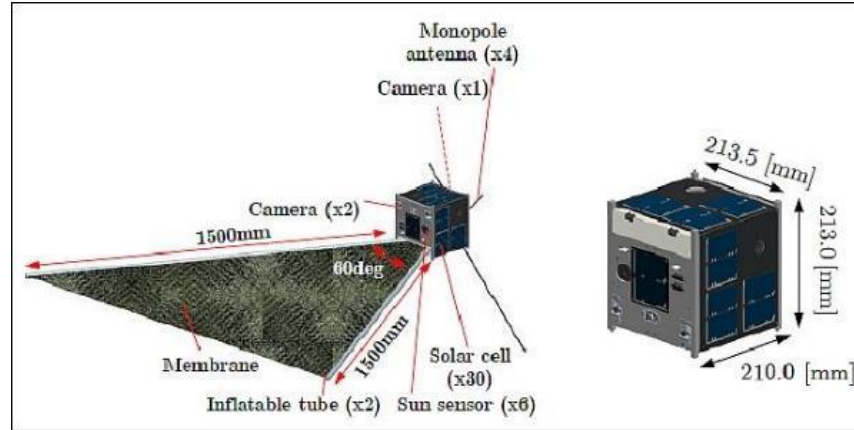

7kg class nano-satellite Membrane deployment experiment using an inflatable structure by SPROUT (Nihon University)



4. Development Example 1: Deployment switch on CubeSat

4. Development Example 1: Deployment switch on CubeSat

4.1 Configuration

Three switches to **turn on power** when the satellite is released from rocket.

Example: 3 deployment switches of OrigamiSat-1

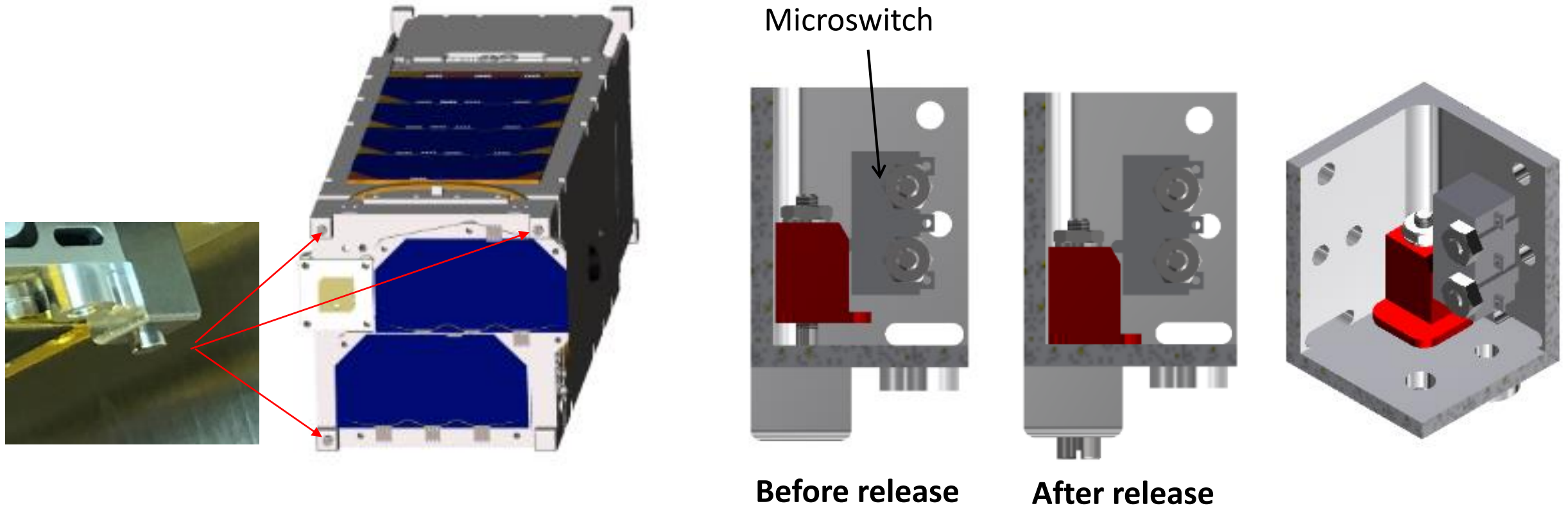

4. Development Example 1: Deployment switch on CubeSat

4.2 Lessons learned

Deployment switch

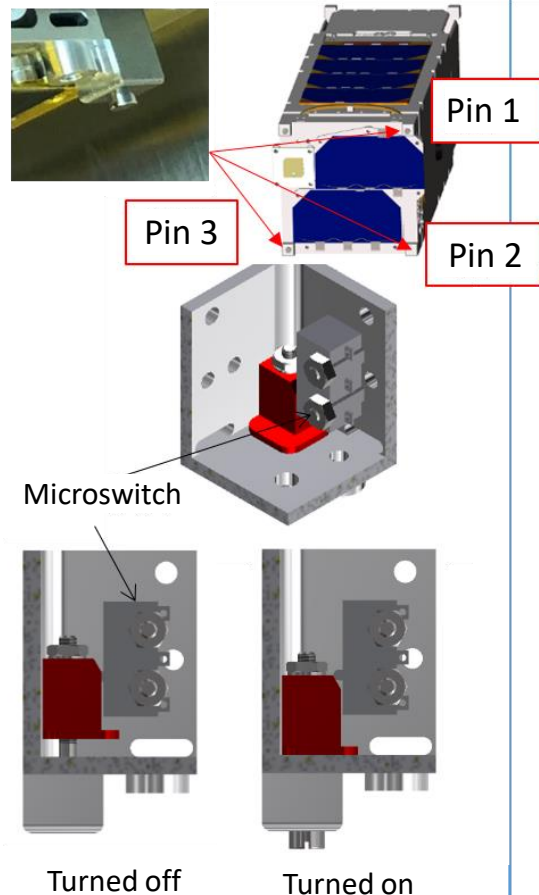

After the FM vibration test, **deployment Switches 1 and 3** did not work, due to adhesion of the pins. 3 reasons were identified.

1. **Error in manufacturing dimension:** Holes for the FM pins were slightly smaller than the EM holes.
2. **Error in surface roughness of pins:** FM pins had scratches on the surface due to improper handling, resulting in high friction.
3. **Error in microswitch alignment:** Friction between pin and hole was large because of poor alignment during FM assembly.

After following improvements, the **2nd FM vibration test** was conducted to verify proper functions of all deployment switches.

1. **Errors in manufacturing dimensions:** Hole diameter was enlarged within the dimensional tolerance.
2. **Error in surface roughness of pins:** After scratches on the pin surface were removed, MoS₂ coating was applied.
3. **Error in microswitch alignment:** Alignment was carefully adjusted during re-assembly.



5. Development Example 2: Deployable solar panel

5. Development Example 2: Deployable solar panel

5.1 Configuration (1/2)

Example: Solar panel deployment mechanisms on Hodoyoshi 3, Hodoyoshi 4 (Ref. [4][5])

Launched by Dnepr Launch Vehicle from Yasne Cosmodrome, Russia on Jun. 2014.

The solar panels were successfully deployed on first pass over Japan.



Hodoyoshi 3



Hodoyoshi 4

References:

[4] Yuta Araki, et al., S192011, JSME Annual Convention, 2013. (in Japanese)

[5] Yuta Araki, et al., 2K03, JSASS Space Science and Technology Symposium, 2014. (in Japanese)

	Hodoyoshi 3	Hodoyoshi 4
Size	500 x 500 x 700mm	500 x 500 x 800mm
Mass	56kg	66kg
Orbit	Altitude about 630km, Circular, Sun Synchronous	
Attitude control	Sun-oriented spin control, Sun oriented 3 axes control, Earth oriented 3 axes control (coarse, fine)	
Power	Solar cell: 2 deployable paddles + body mount 5 faces Power generation: 130W (max) Power consumption: 50W (during observation, average) Power system: 28V unregulated, (partially) 5V regulated Battery: Li-ion	
Comm	Telemetry/command: S-band (Command 4kbps, Telemetry 32/64kbps) Mission data: X-band (10Mbps) *Hodoyoshi 4 also tests 100Mbps communication	
Orbit control	H ₂ O ₂ thruster	Ion engine
Mission	Earth observation camera GSD: 240m (low resolution) GSD: 40m (medium resolution) Payload space x 3 Store & Forward	Earth observation camera GSD: about 6m (high resolution) Payload space x 4

5. Development Example 2: Deployable solar panel

5.1 Configuration (2/2)

Solar panel deployment mechanism:

- Hinge with a latch
- Hold and Release Mechanism (HRM)

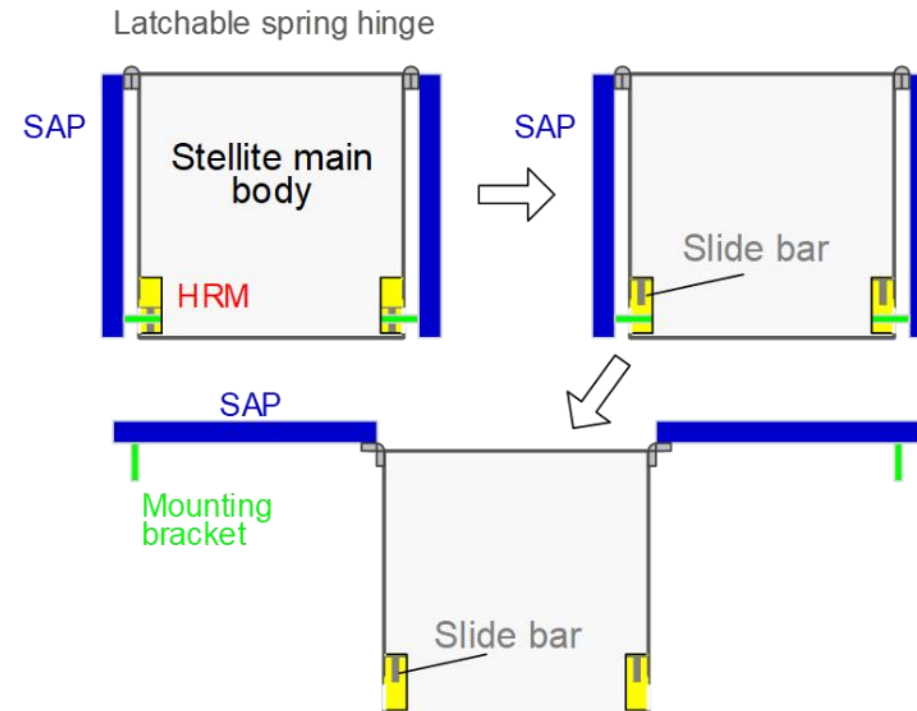
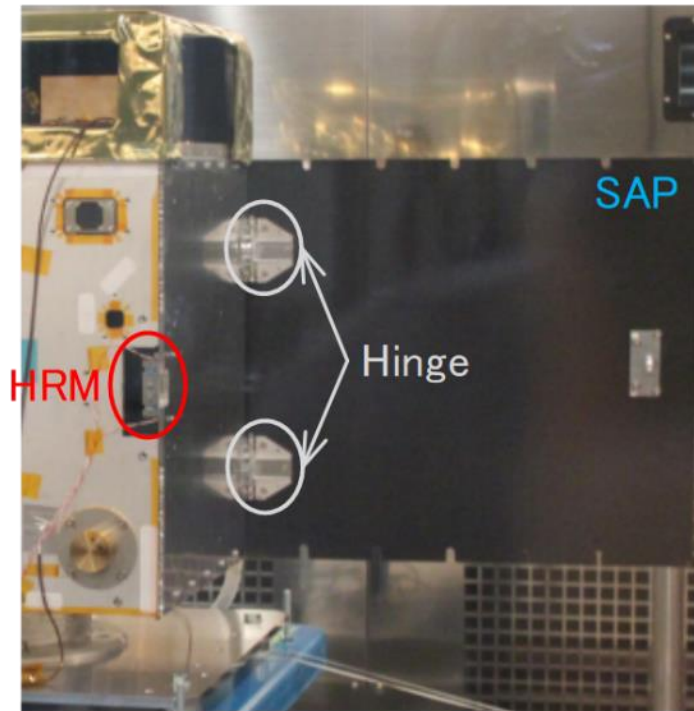

Ref. [4]

5. Development Example 2: Deployable solar panel

5.2 Hinges with a latch

- ✓ A latch can be applied by inserting a latch pin into a hole drilled **at an arbitrary angle**.
- ✓ **The hinge and latch mechanism are integrated into one unit**, to reduce the size and weight.
- ✓ Dimensions can be changed according to the panel size and the required torque to **accommodate a variety of panels**.

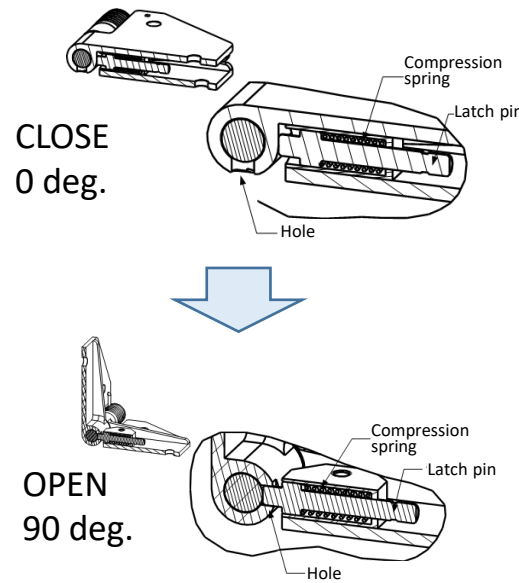
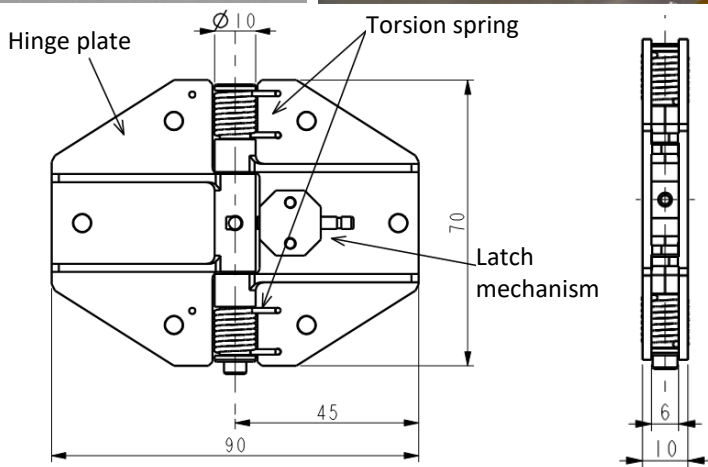
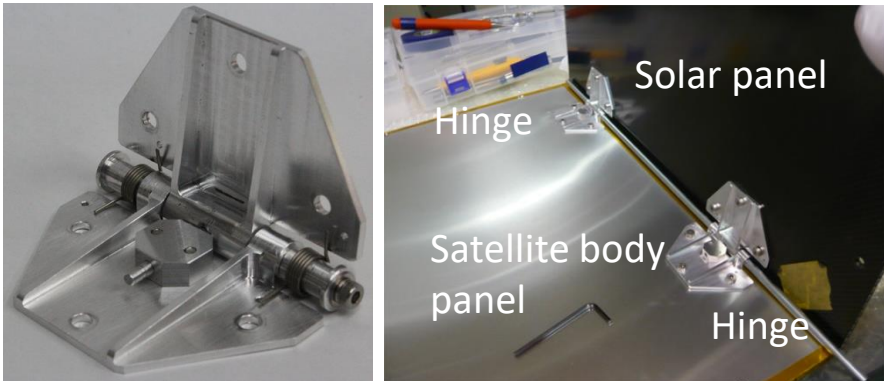

Ref. [4]

Size	70 mm x 90 mm x 10 mm Clearance in stored config.: 6 mm, Clearance of shaft: 0.4 mm
Mass	46.3 g
Torque	564.3 N·mm (per hinge), adjustable by changing torsion spring
Latch method	Latch pin sticks into hole by compression spring
Deployment angle	CLOSE: 0 deg., OPEN: 90 deg.
Component	Hinge plate x 2, Hinge shaft, Torsion spring x 2, Latch mechanism (Latch mechanism compartment, Latch pin, Compression spring)

5. Development Example 2: Deployable solar panel

5.3 Hold and release mechanism (HRM)

- ✓ A “gate-bar method” using a thread burning mechanism
- ✓ A tension adjustment mechanism
- ✓ A microswitch for checking the motion of the gate-bar latch pin
- ✓ A compact, lightweight, low-cost, and simple mechanism (small number of parts)

Ref. [4]

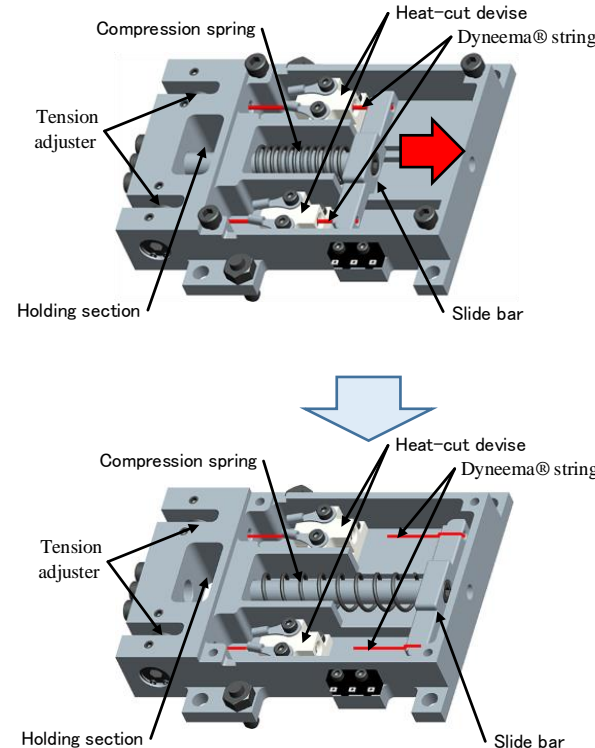
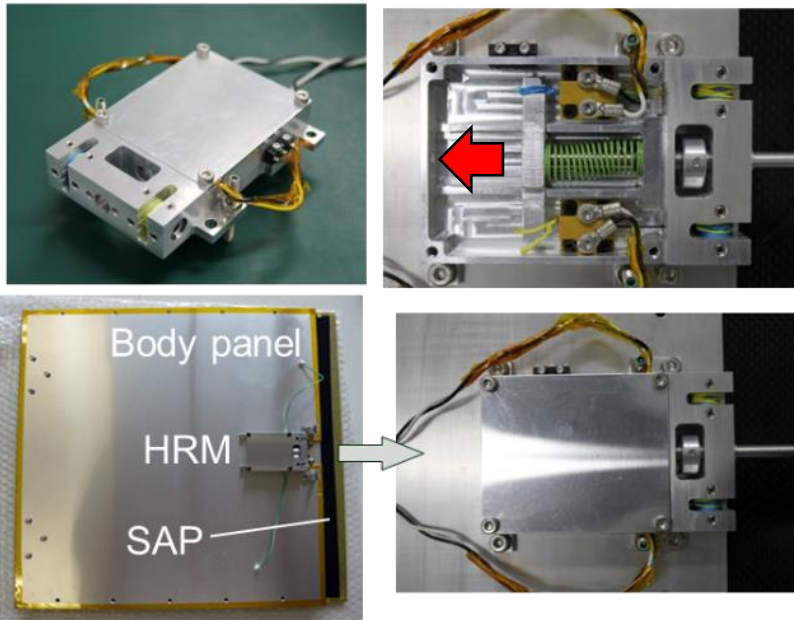

Size	86 mm x 70 mm x 19 mm
Mass	153.3 g
Power	Operation voltage: 28 V, Current ≤ 1 A (5V, 4A is applied to nichrome wire using DC/DC circuit in HRM)
Operation Temperature	-30°C ~ 60°C (Deployment time ≤ 10 s)
Method	Pulling gate-bar with thread burning mechanism
Component	Gate-bar pin, compression spring, Thread burning mechanisms x 2, Thread (Dyneema®), Tension adjustment unit, Ball plunger x 2, Microswitch

5. Development Example 2: Deployable solar panel

5.4 Design improvements (1/4)

Mechanisms did not work properly during development

After verifying the function of the hinge with a latch and the HRM, a deployment test was conducted with mechanisms installed in the satellite; however neither solar panels opened.

- ❑ **On one side**, the HRM worked, and the solar panel started opening, but it stopped in the middle of deployment.
 - ✓ The hinge was very stiff after assembly.

- ❑ **On the other panel**, the HRM did not work and the solar panel did not start deployment.
 - ✓ The threads were properly burned, but the gate-bar pin of the HRM was engaged with a bracket on the solar panel.

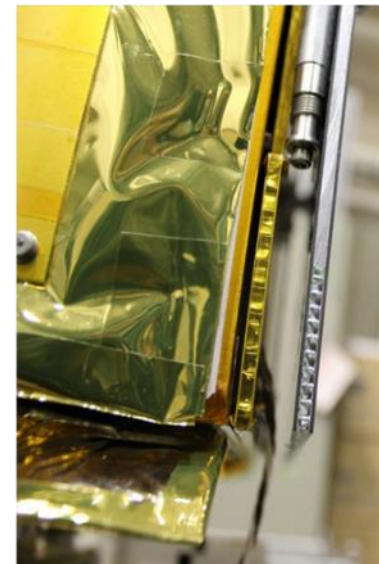
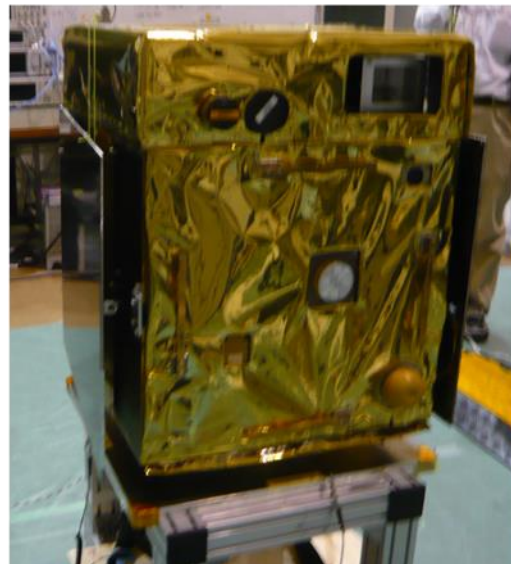

Ref. [5]

5. Development Example 2: Deployable solar panel

5.4 Design improvements (2/4)

❑ Panel deployment stopped in the middle:

Caused by misalignment of the rotational axis of the two hinges. This misalignment occurred when the solar panel with hinges was assembled to the satellite body.

1. Clearance between the shaft and hole of the hinge was changed from 0.1 mm to 0.4 mm to absorb distortion during assembly.

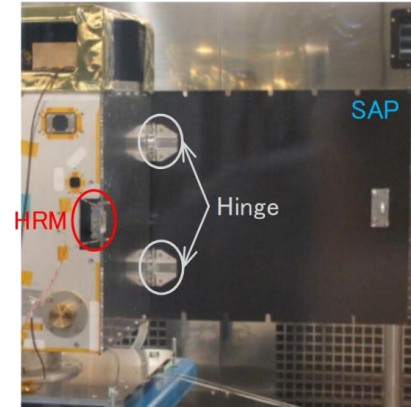
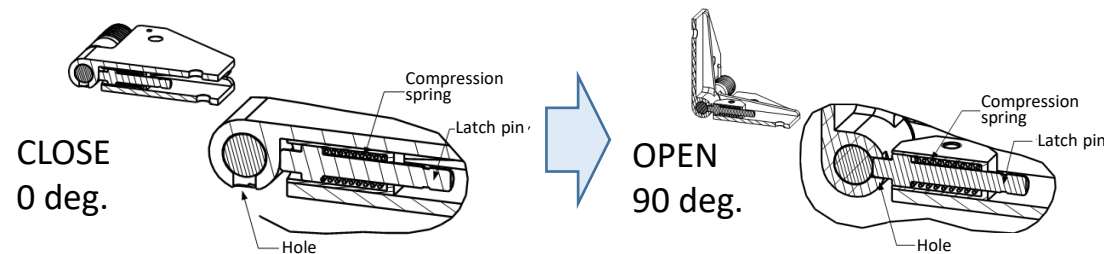
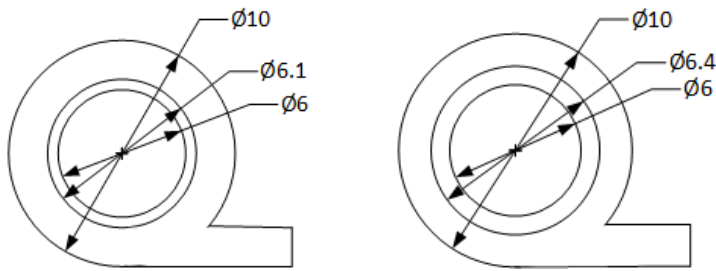

2. A stronger torsion spring is used. The deployment torque of the hinge was increased from 230 N mm to 1130 N mm.

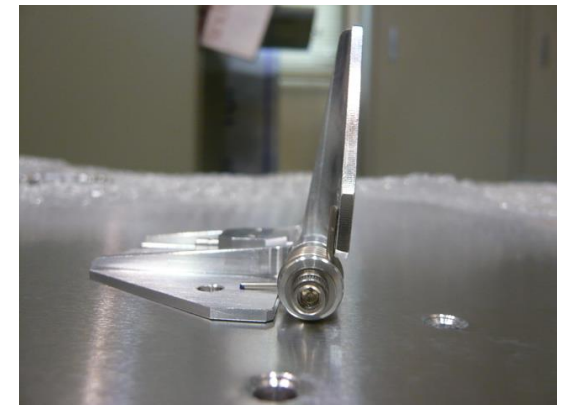
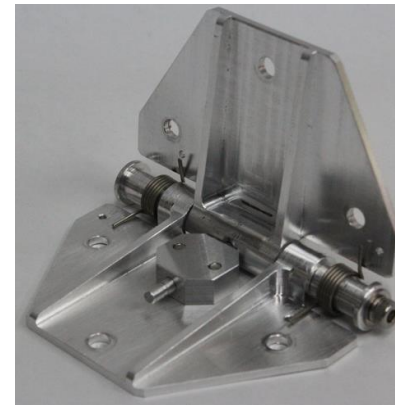

Ref. [5]

5. Development Example 2: Deployable solar panel

5.4 Design improvements (3/4)

❑ HRM gate-bar pin was not pulled out completely.

Friction between the HRM gate-bar pin and the hole of the solar panel bracket was larger.

Before the threads are burned, the spring force to pull the gate-bar pin applies perpendicular to the pin **because of the gap in the hole**, to increase friction. The resistance force due to friction was estimated again.

1. A Teflon bush was added inside the hole as **solid lubricant**.
2. Edges of the hole (contact point) was **rounded with larger radius**.

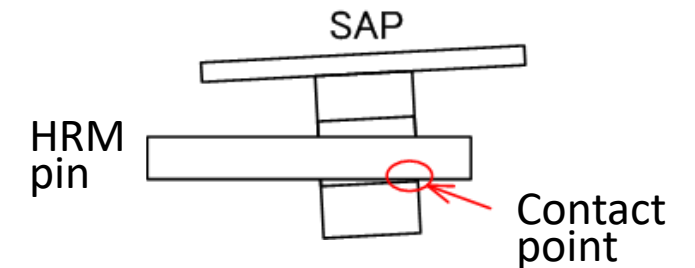
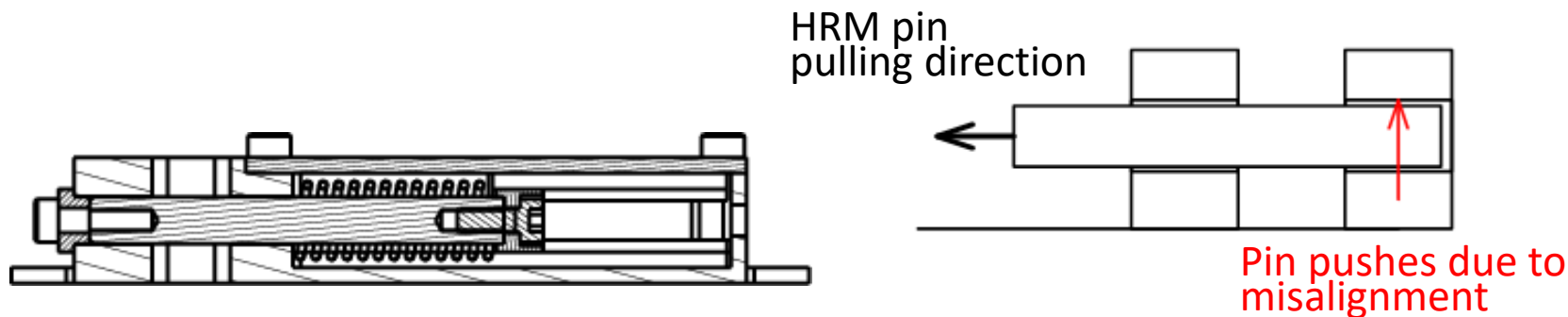
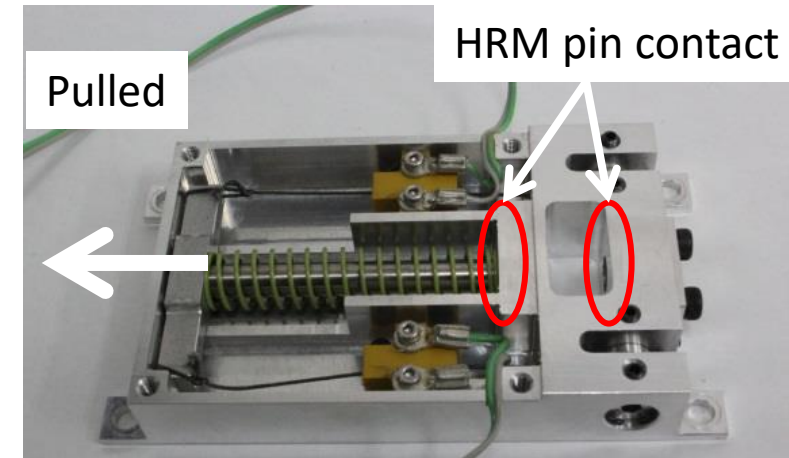

Ref. [5]

5. Development Example 2: Deployable solar panel

5.4 Design improvements (4/4)

Panels with improved design were carefully re-assembled.

- ✓ Perpendicularity and positional relationship of each part were **adjusted carefully** using shims during the structure assembly to achieve a better alignment.

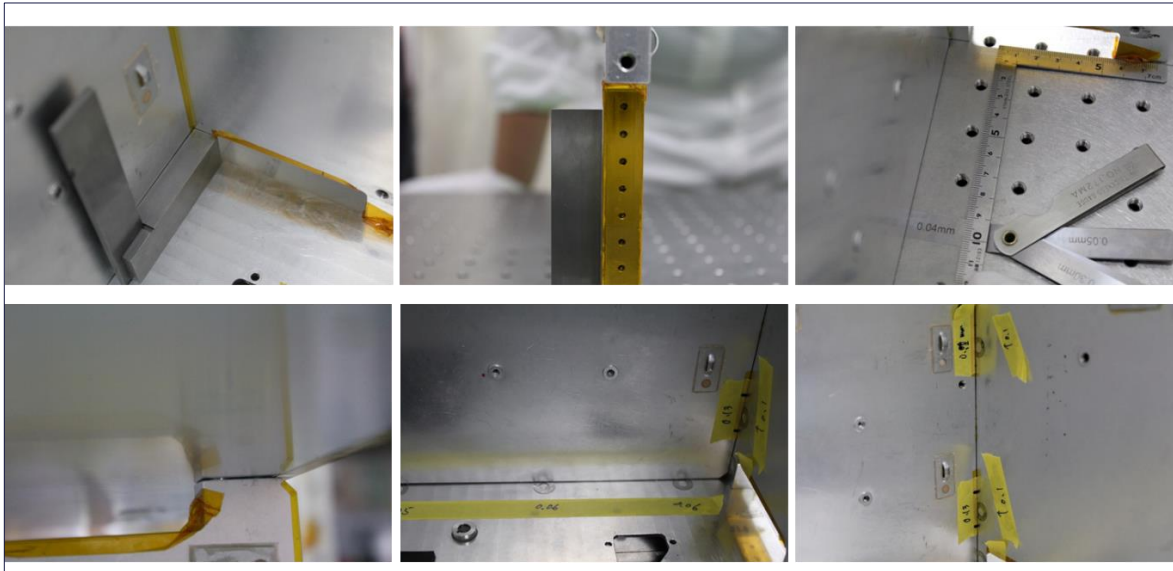

- ✓ **Conducted deployment tests successfully** at 0°C and 40°C in thermostatic chamber.

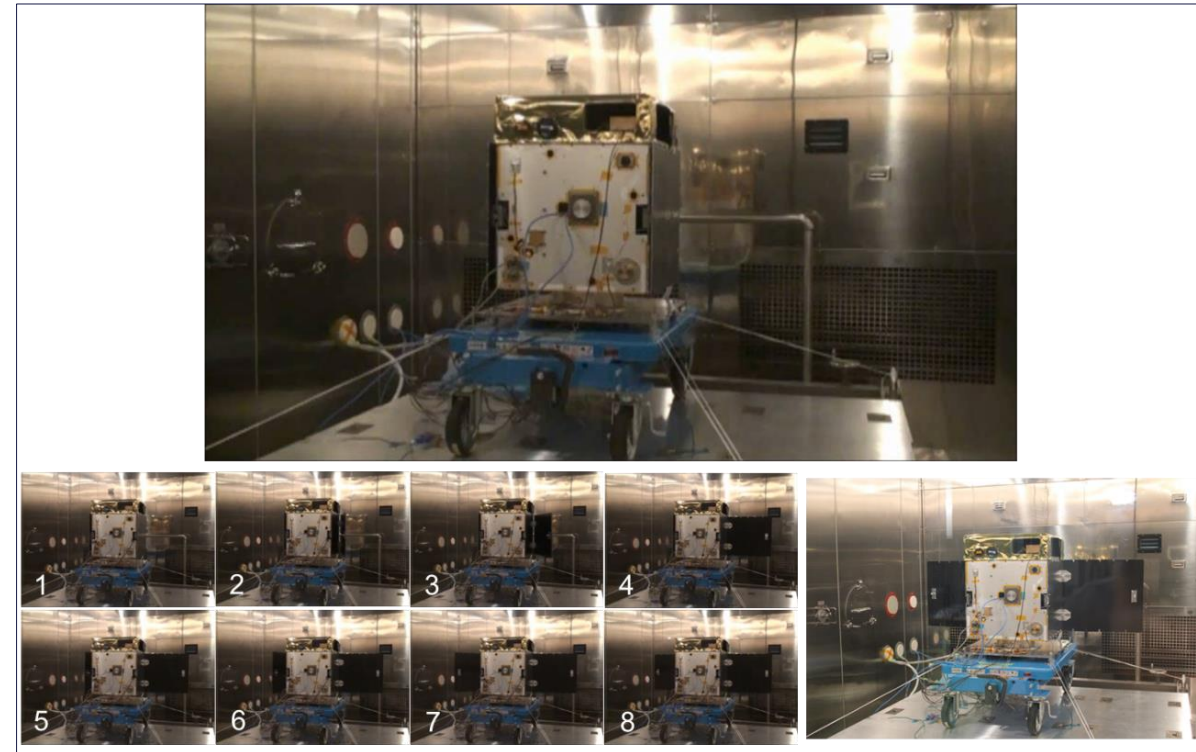

Ref. [5]



6. Development Example 3: Deployable membrane

6. Development Example 3: Deployable membrane

6.1 Configuration

Example: Cutter unit of membrane HRM on OrigamiSat-1

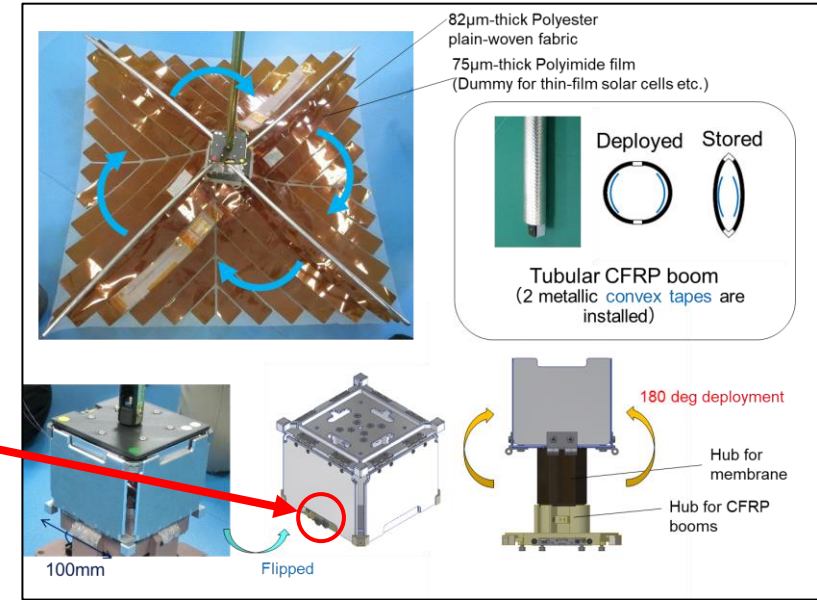
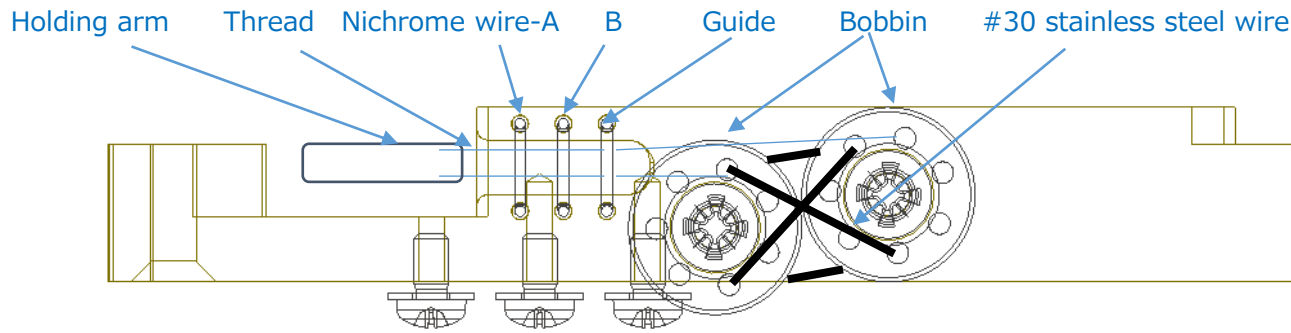

- ✓ For improving burning (cutting) reliability, 2 systems of nichrome wires, A and B, are used in parallel.
- ✓ First, the thread is looped using a **double sheet-bend knot**. The thread loop is tied to the end of the holding arm with a **loop knot**, then it is passed through the nichrome wires to each bobbin, which is then wound and screwed.

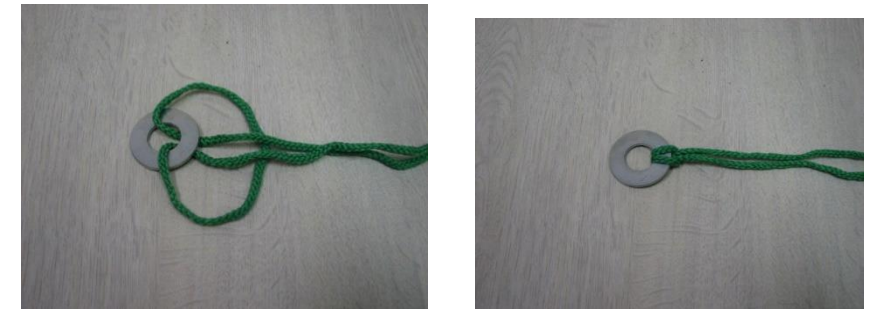

Figure: "Loop knot" used on the end of the cam plate

6. Development Example 3: Deployable membrane

6.2 Gravity compensation (1/2)

Deployment test of OrigamiSat-1's multifunctional membrane



(April 2017, at Tokyo Tech Furuya Lab.)

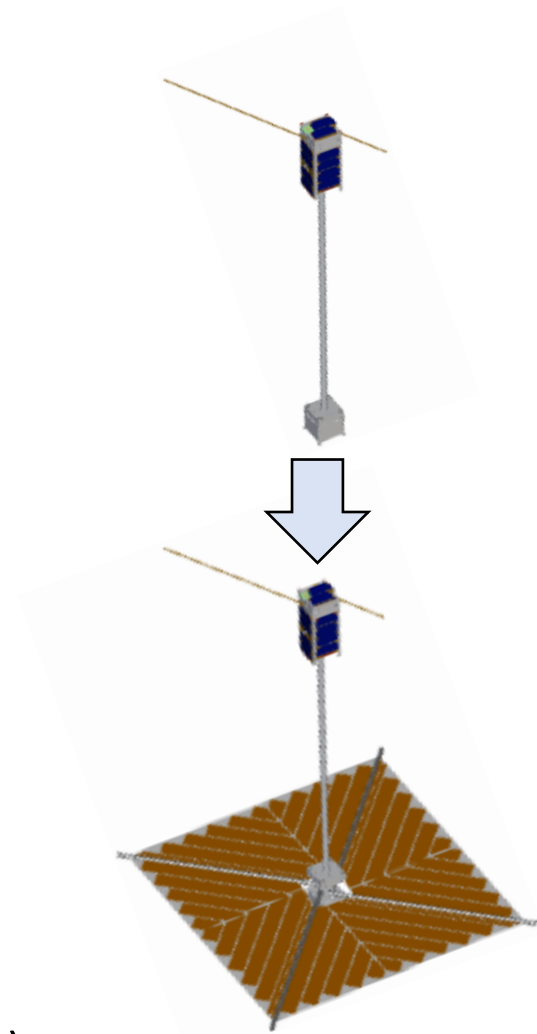

6. Development Example 3: Deployable membrane

6.2 Gravity compensation (2/2)

- ✓ Since it is difficult to completely simulate on-orbit dynamics on the ground, the effects of each deployment assistance force/deployment resistance force are separately estimated.
- ✓ However, if the estimated forces are not validated before launch, there is always risk. In order to reduce the risk, efforts should be made to simulate on-orbit conditions as much as possible. = Gravity compensation
- ✓ **Example:** What is the appropriate length for a gravity compensating suspension thread?

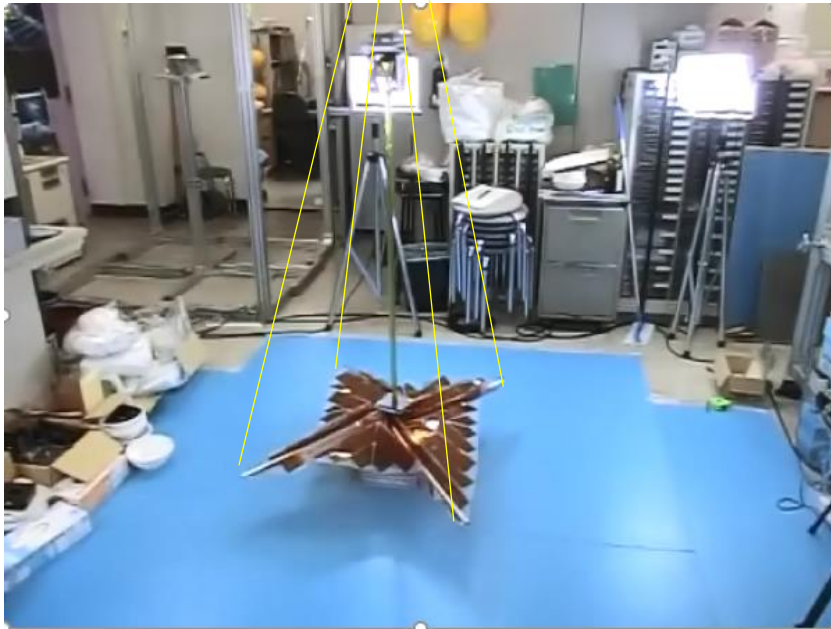

Deployment mechanism characteristic factors

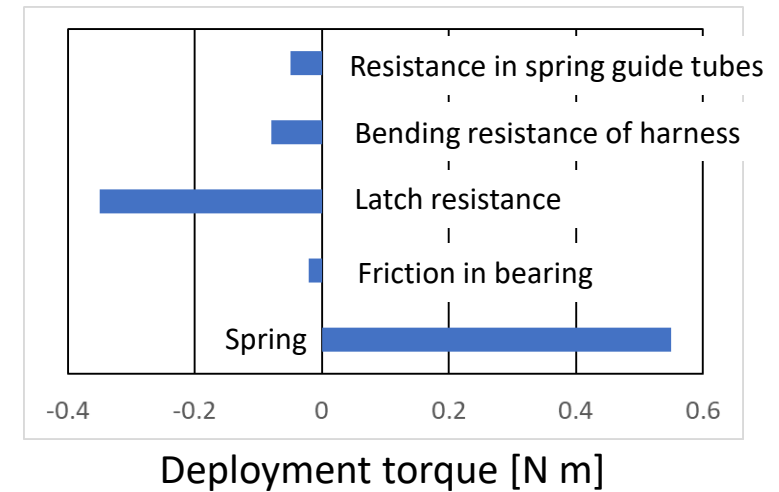

Example: Torque in flip-up mechanism of 3.5m reflector for communication on ETS-VI satellite (at low temperature) [1]



7. Conclusion

7. Conclusion

- ✓ It is extremely difficult to **predict all failure modes** of mechanisms without manufacturing and testing.
 - Mechanisms are normally **more difficult to analyze** than the usual satellite structure, so early prototyping is essential.
 - **Repeat manufacturing and testing** from the mock-up level to identify failure modes as early as possible.
- ✓ Watch out for an increase of resisting force/torque due to **misalignment** caused by **dimension tolerances, cold-welding, assembly error, and thermal deformation**.
- ✓ Design **proper experimental methods on ground** to enable verification of the mechanism's function.

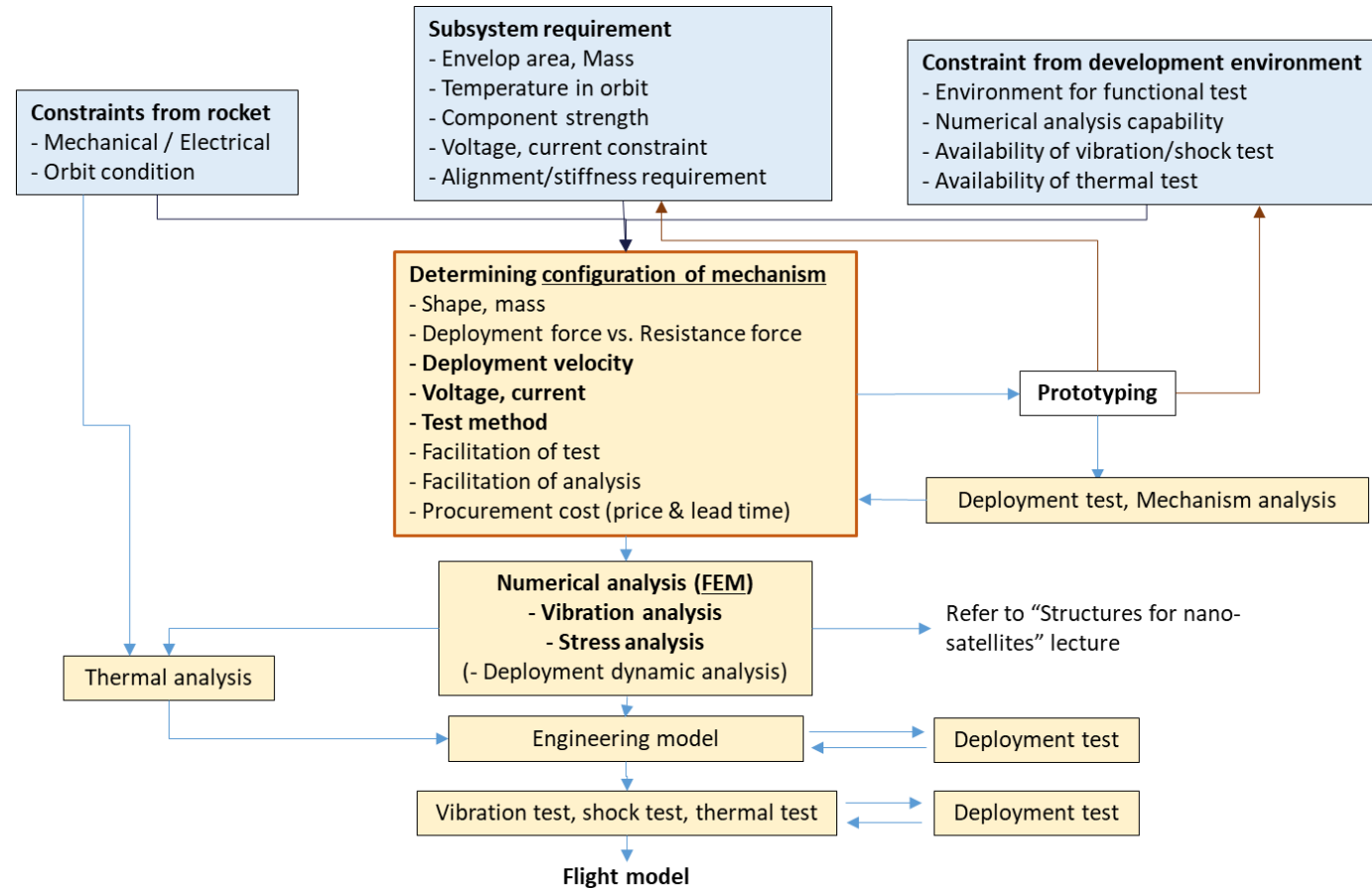



Thank you very much.

[Disclaimer]

The views and opinions expressed in this presentation are those of the authors and do not necessarily reflect those of the United Nations.