

KiboCUBE Academy

Lecture 18

Introduction to CubeSat Payload System

Nihon University

Department of Aerospace Engineering

Associate Professor Dr. Engineering. Masahiko Yamazaki

This lecture is NOT specifically about KiboCUBE and covers GENERAL engineering topics of space development and utilization for CubeSats.

The specific information and requirements for applying to KiboCUBE can be found at:

<https://www.unoosa.org/oosa/en/ourwork/psa/hsti/kibocube.html>





Education



© Nihon University

Tech. Demo.



© Nihon University

Tech. Demo.

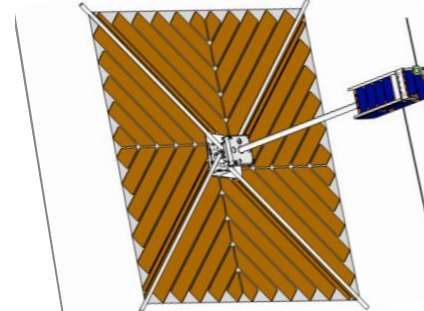

© Tokyo Institute of Technology

Science

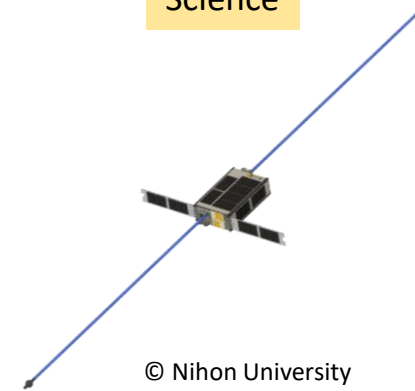

© Nihon University

Education



© UNISEC

Masahiko YAMAZAKI, Ph.D.

Position:

2017 - Chairperson, University Space Engineering Consortium Japan (UNISEC)

2017 - Program Manager, CubeSat Hands-on Education Program HEPTA-Sat, UNISEC

2019 - Associate Professor, Department of Aerospace Engineering, Nihon University

2019 - Project Manager, 6U Earthquake Precursor Study CubeSat Prelude-Sat : Prelude

Research Topics:

Systems engineering for small spacecraft development and utilization

Contents

1. Introduction to Payload for CubeSat
2. Introduction to CubeSat
3. Introduction to CubeSat Systems
4. Types of Payload Systems & Examples of CubeSat mission payloads
5. Conclusion



1. Introduction to Payload for CubeSat

1. Introduction to Payload for CubeSat

1.1. What is payload? : Characteristics of Space Utilization

- There are many types of CubeSat orbits. The orbit is determined by several parameters such as altitude, orbital shape, and angle with the equatorial plane.
- A CubeSat orbiting the earth can cover a wide area on the earth.

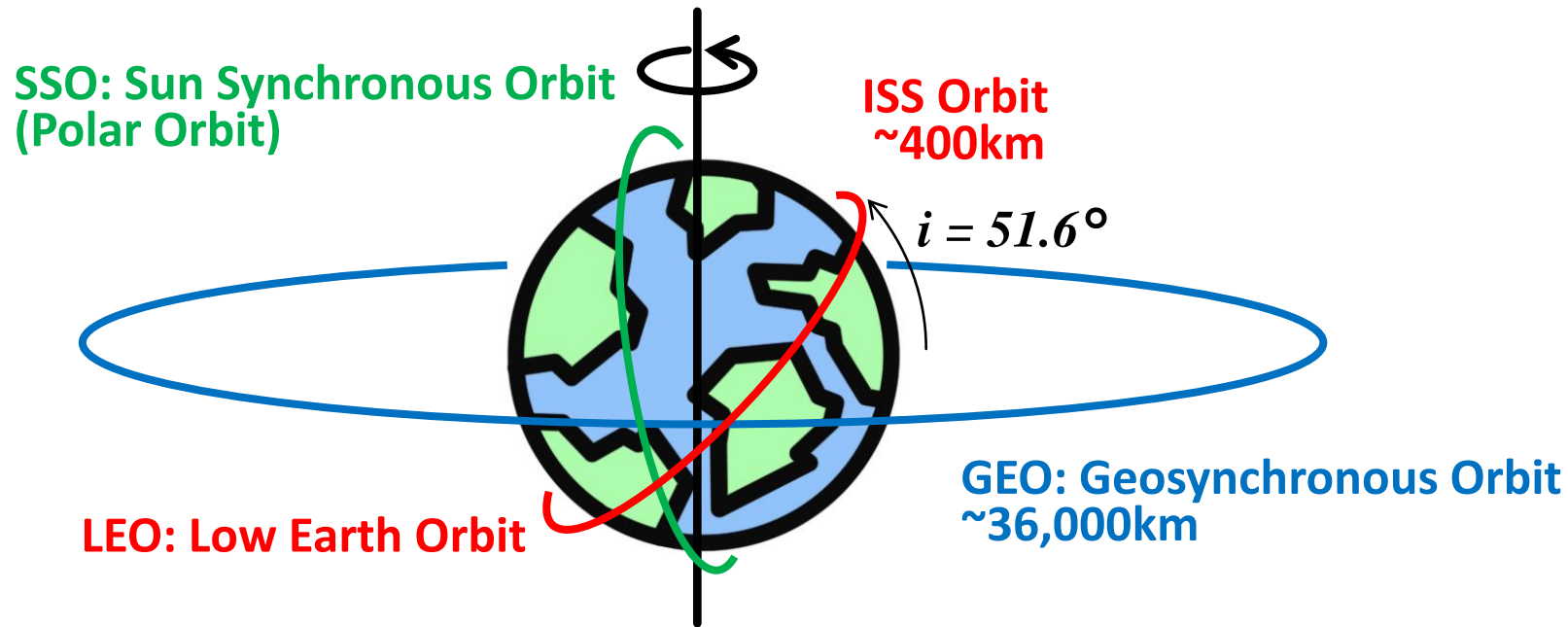

CubeSat, orbiting in a high inclination orbit, can cover a large geographic area.

A higher orbit provides a wider field of view and a lower orbit provides a higher ground resolution.

1. Introduction to Payload for CubeSat

1.1. What is payload? : Characteristics of Space Utilization

📦 This global accessibility feature can be utilized for :

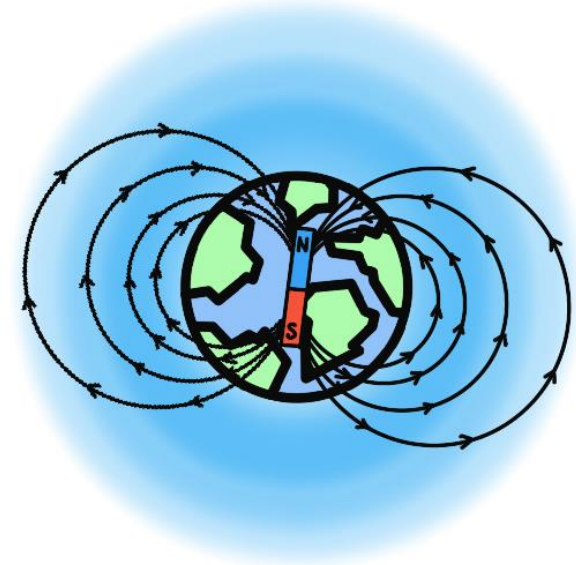
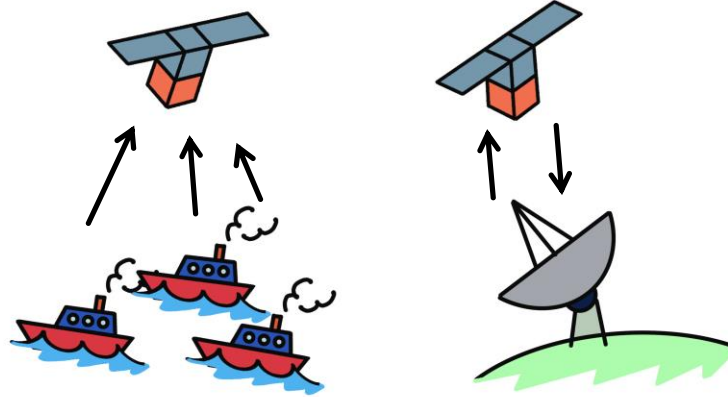
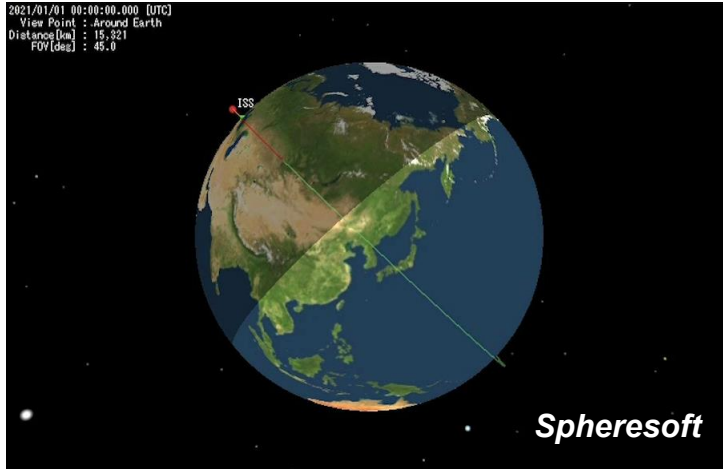

Earth observation:

periodic, frequent observation of ground area under the satellite orbit.

Communication:

communication contact with ground stations in the visible area.

Environmental measurement:

measure the space environment, such as magnetic fields, radiations, etc.

The unique environment provided by space, including microgravity, vacuum, high radiation, ultraviolet radiation, low and high temperatures, and the presence of atomic oxygen and plasma, can be used for variety of experiments in earth science, materials science, bioscience, and medical science.

1. Introduction to Payload for CubeSat

1.1. What is payload? : CubeSat payloads are the heart of missions in space

- ❏ The **payload** is the part of the CubeSat system that carries out its mission.

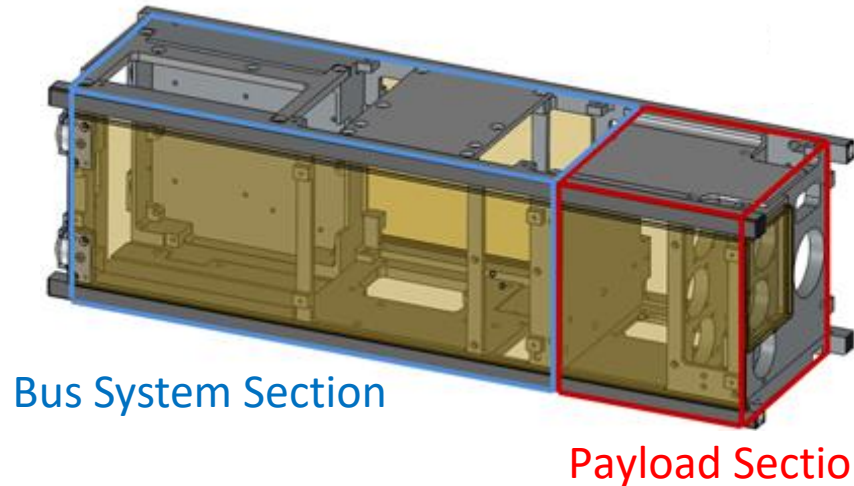

3U CubeSat S-CUBE © Chiba Institute of Technology / Tohoku University



Payload Section
Bus System Section

1U CubeSat SEEDS-II
© Nihon University

- ❏ The **bus** is the part of the CubeSat system to survive in space.

For educational missions, the CubeSat itself becomes the payload.

1. Introduction to Payload for CubeSat

1.1. What is payload? : CubeSat payloads are the heart of missions in space

❖ The **payload** is the part of the CubeSat system that carries out its mission.

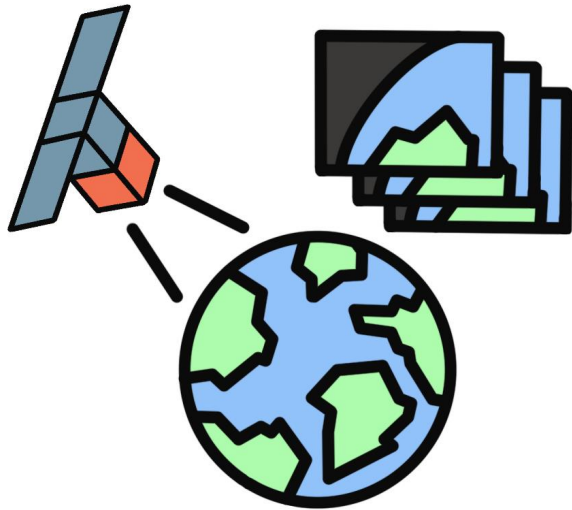

to take images of the Earth =
Earth Observation Camera

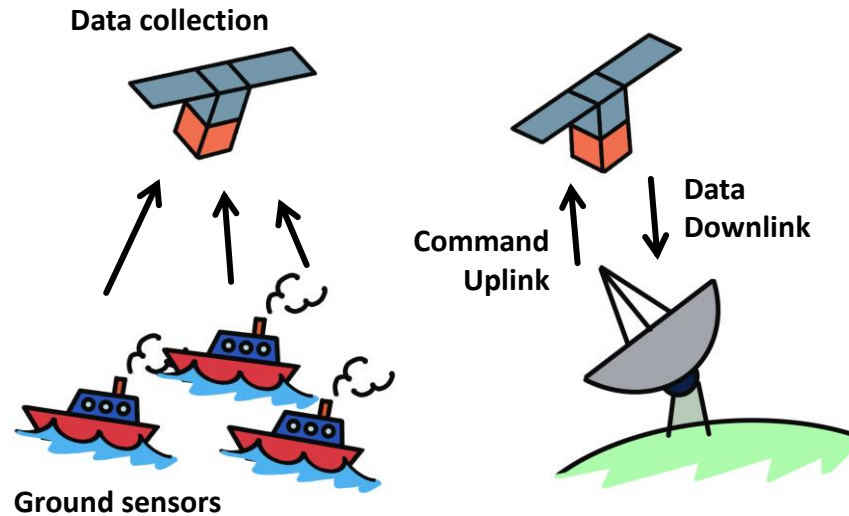

to receive, process and send information
= Communication Instruments

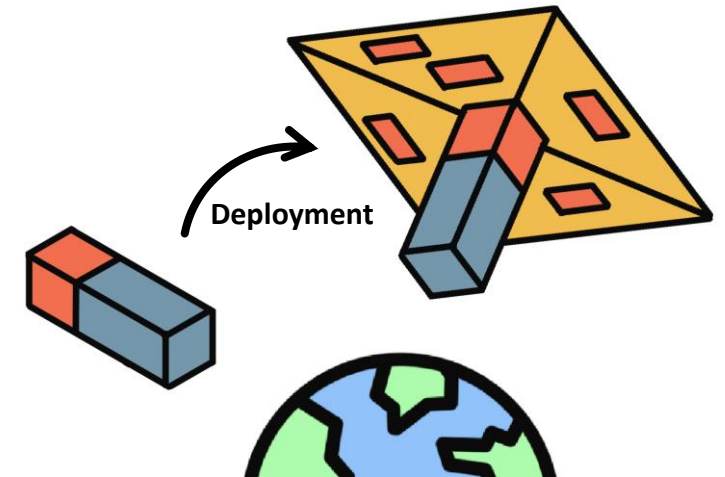

to see how a certain technology
behaves in space = component to
be engineering demonstrated

The payload is the central element in accomplishing the mission.

1. Introduction to Payload for CubeSat

1.1. What is payload? : satellites' lifecycle

- ❏ CubeSat has several different phases in its ***lifecycle***.
- ❏ Design and development phase, Launch & Orbit insertion phase, Operation phase, etc.

Design and Development

Launch & Orbit insertion

Operation

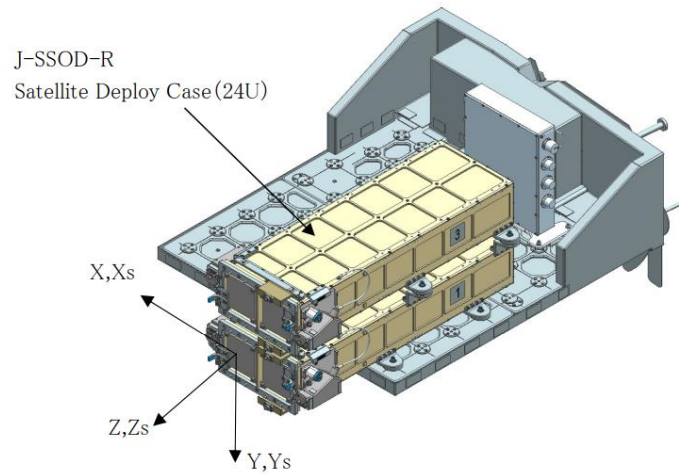
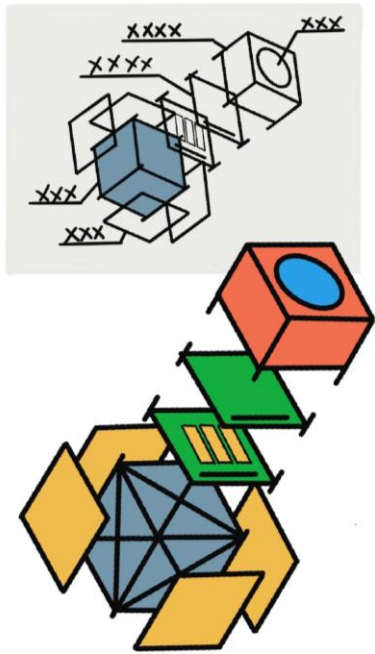

Reference: JEM Payload Accommodation Handbook Vol. 8 D
https://iss.jaxa.jp/kibouser/library/item/jx-esp8_8d.pdf

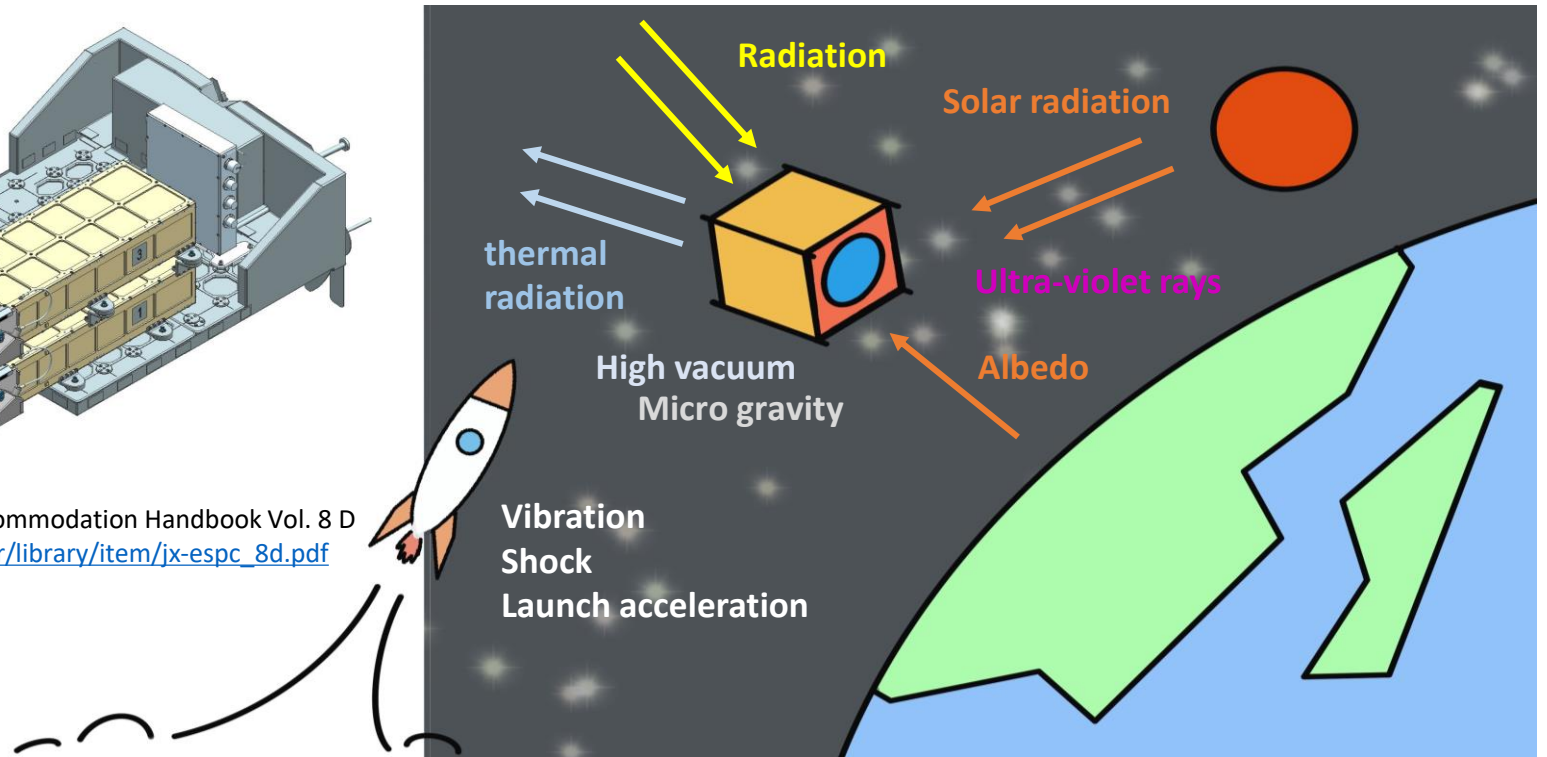

The payload/cube-sat design must fully meet all requirements and constraints across the entire lifecycle.

1. Introduction to Payload for CubeSat

1.1. What is payload? :

❏ **Payload** is not the only element of CubeSat that makes the mission possible.

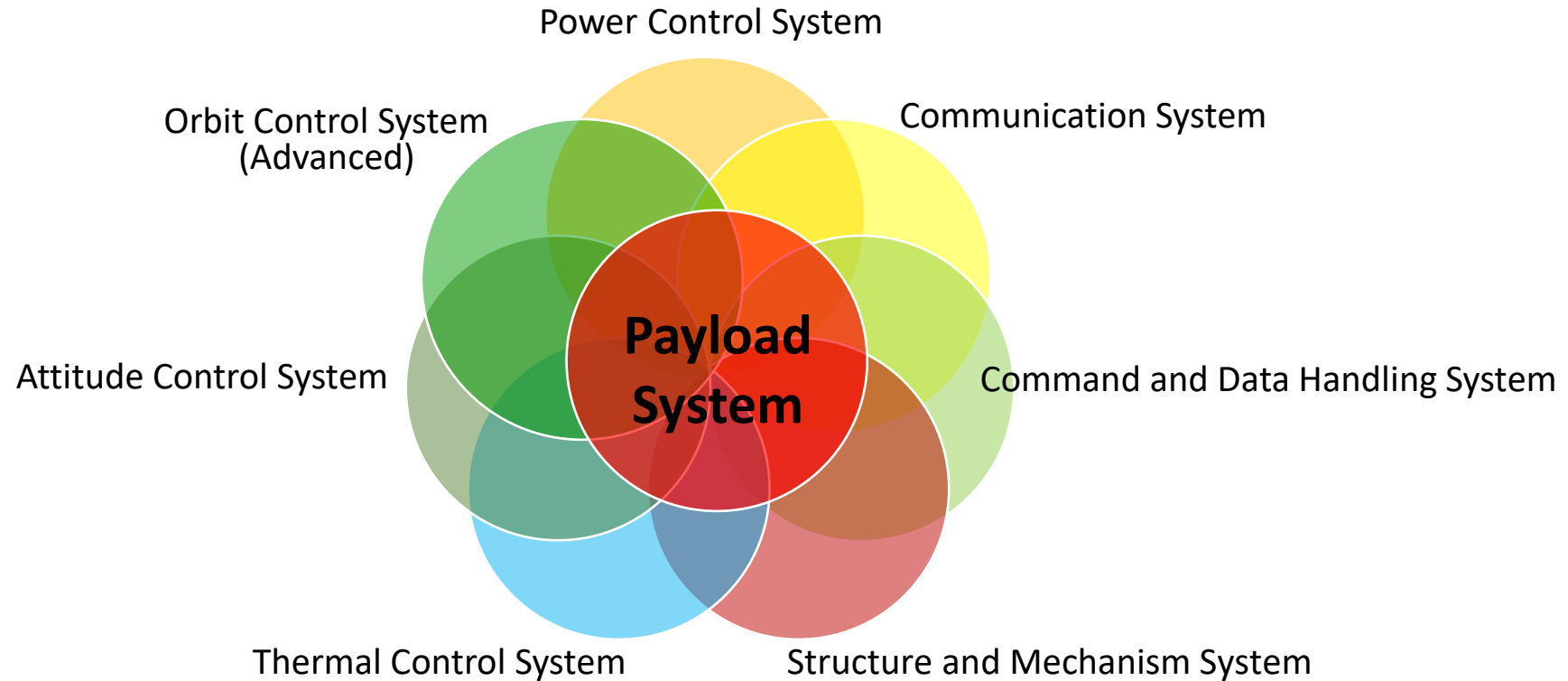

It is important to understand the CubeSat life cycle and the CubeSat operational environment in order to identify the requirements and constraints associated with the payload in order to clarify the required functions.



2. Introduction to CubeSat

2. Introduction to CubeSat

2.1. What is CubeSat? : CubeSat standard (shape, size, and weight)

- ❏ A CubeSat, must conform to specific criteria that control factors such as its **shape, size, and weight.**
 - ❏ **This affects resources such as size and power available for payloads.**
- ❏ The specific standards for CubeSats help reduce costs.
- ❏ A 1U CubeSat is a **10 cm cube** with a mass of approximately **1 to 1.33 kg.**

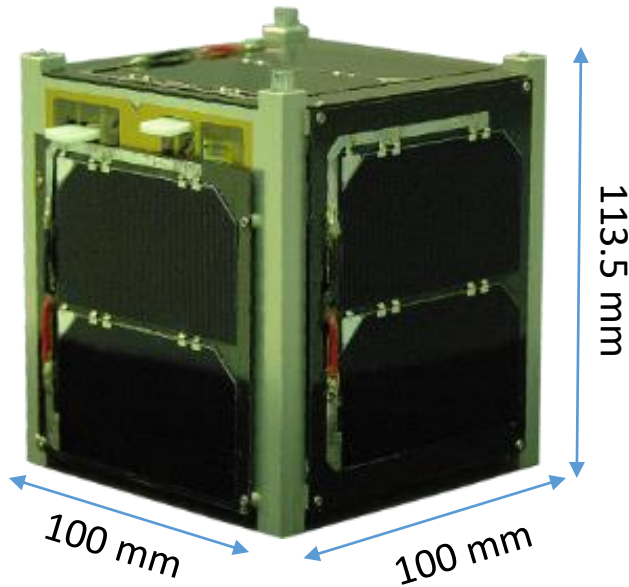

1U CubeSat SEEDS-II © Nihon University

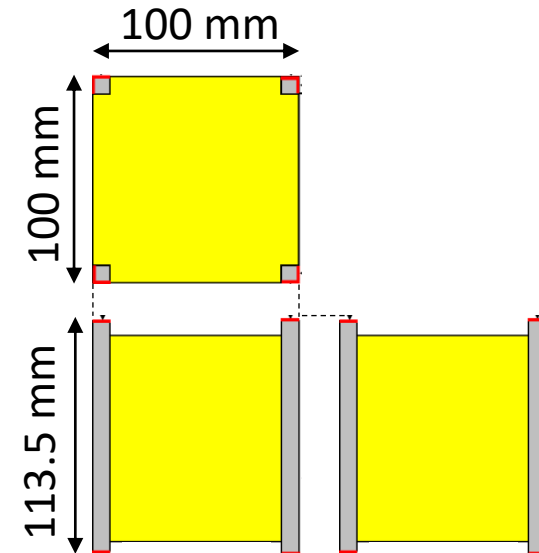

1 Unit: 10 cm cube, 1.33kg

2. Introduction to CubeSat

2.1. What is CubeSat? : CubeSat standard (shape, size, and weight)

❏ CubeSats come in several sizes, which are based on the **standard CubeSat unit (called 1U)**.

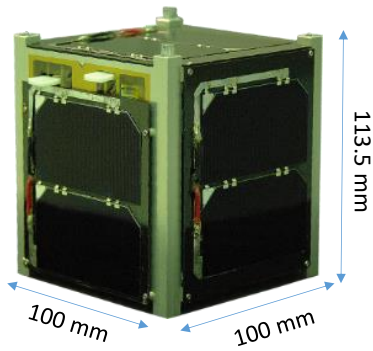

1U CubeSat SEEDS-II
© Nihon University

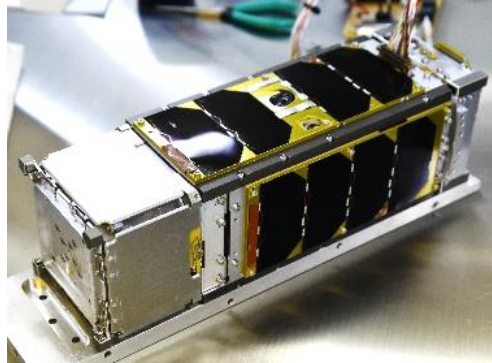

3U CubeSat Origami-Sat
© Tokyo Institute of Technology

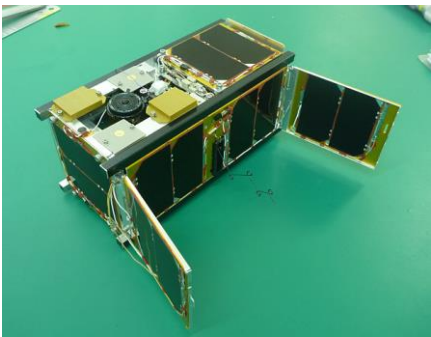

2U CubeSat RAIKO
© Tohoku University



W6U CubeSat Prelude
© Nihon University

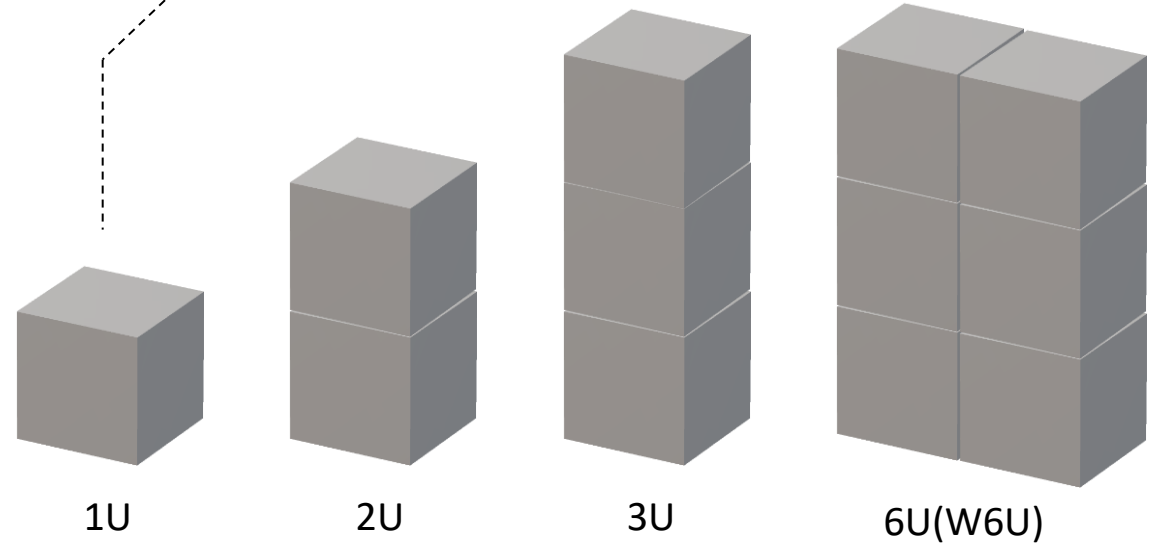

Standard of CubeSat

JEM* Payload Accommodation Handbook Vol.8 D
- JAXA (* Japanese Experiment Module (JEM) = Kibo)
(<https://iss.jaxa.jp/kibouser/provide/j-ssod/#sw-library>)
(https://humans-in-space.jaxa.jp/kibouser/library/item/jx-esp_8d-d1_en.pdf)

2. Introduction to CubeSat

2.1. What is CubeSat? : Relationship of Payload and Bus System

- ❖ A smaller format is mainly for fundamental functionalities to survive in space. Larger formats are required for missions which require larger sensors and components, accurate attitude control and large amounts of data transfer.

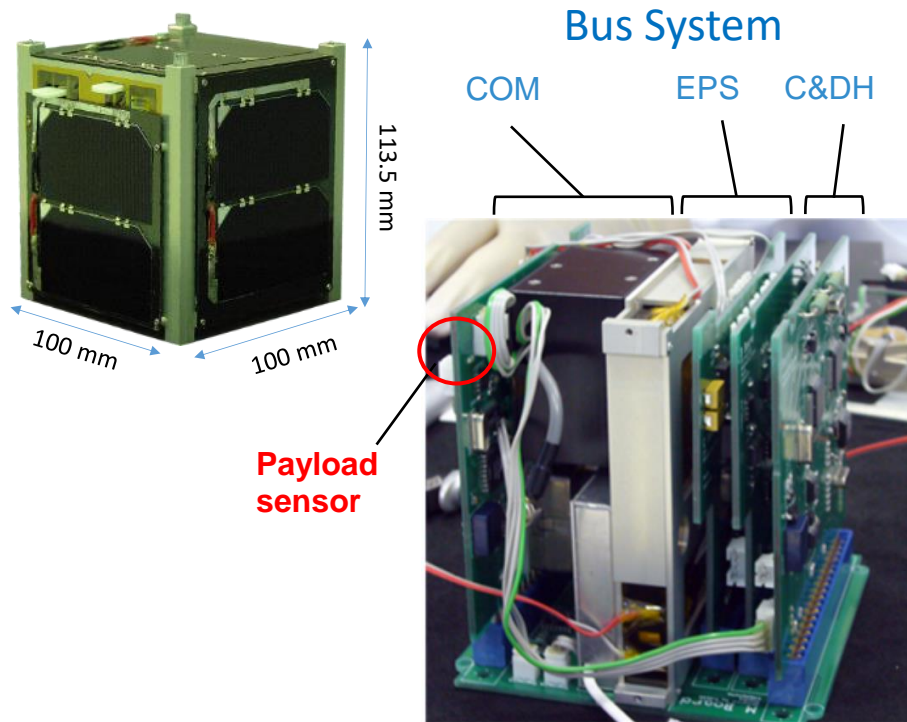

1U CubeSat SEEDS-II © Nihon University

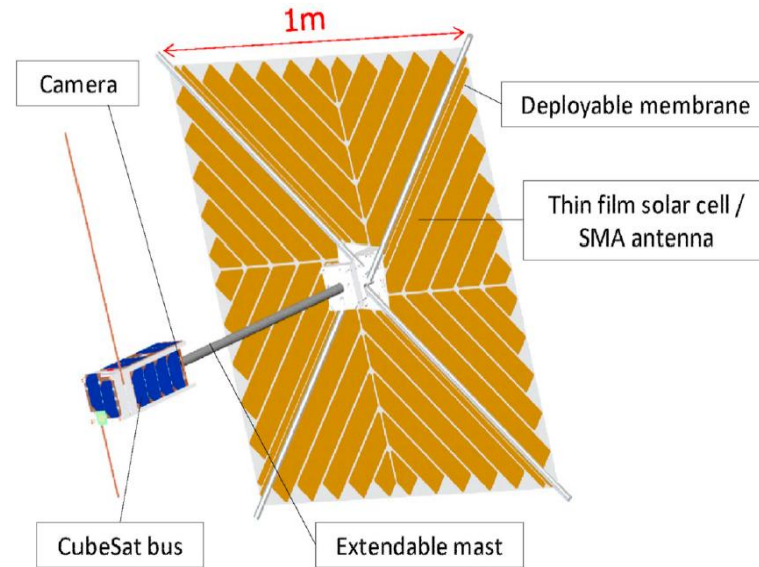

3U CubeSat Origami-Sat © Tokyo Institute of Technology

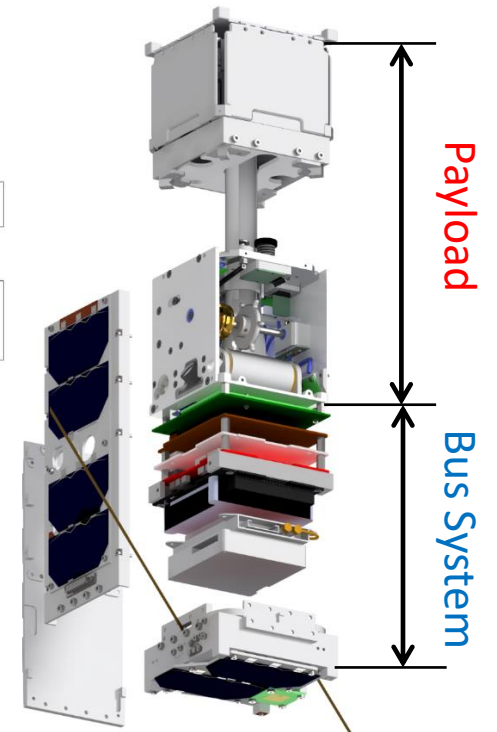

2. Introduction to CubeSat

2.1. What is CubeSat? : CubeSat Orbit Deployer

- ❖ The deployer is the **interface between the CubeSat and the Kibo** (or launch vehicle).
- ❖ The deployer provides attachment to Kibo (or launch vehicle), releases it into orbit at the appropriate time.
- ❖ At the time of release, an electric signal is sent to the CubeSat's deployer, the door opens, and the CubeSat is released into orbit..

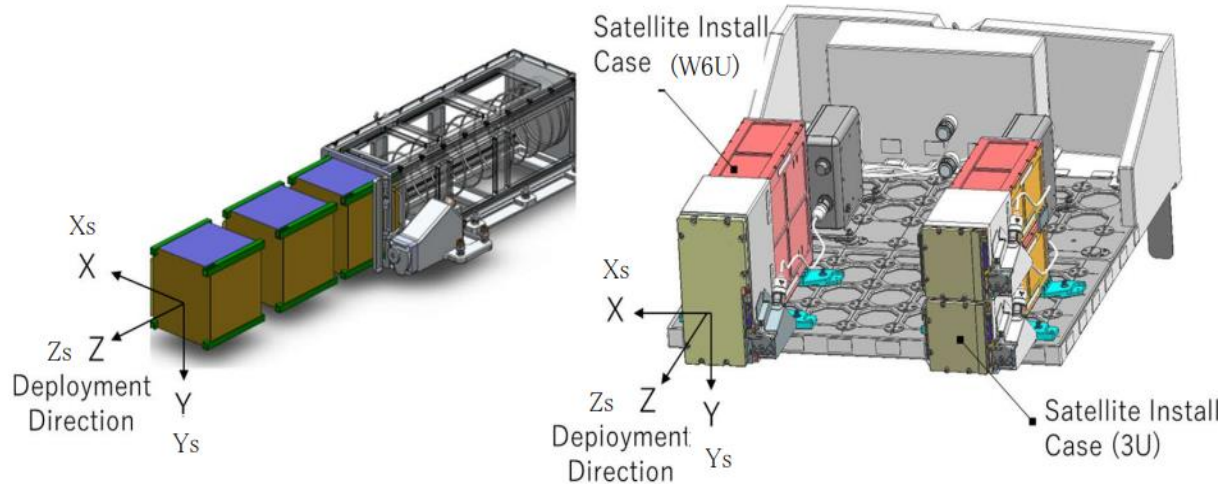

		Exterior Dimensions (*1)	Rail Dimension	CubeSat Installation
10cm Class satellite	1U	X:100×Y:100×Z:113.5mm	More than 8.5mm squares	Ground / ISS
	1.5U	X:100×Y:100×Z:170.2mm		ISS
	2U	X:100×Y:100×Z:227.0mm		Ground / ISS
	3U	X:100×Y:100×Z:340.5mm		Ground / ISS
	4U	X:100×Y:100×Z:454.0mm		ISS
	5U	X:100×Y:100×Z:567.5mm		ISS
	6U	X:100×Y:100×Z:681.0mm		ISS
	W6U	X:100×Y:226.3×Z:340.5 or 366.0mm	Ground	

(*1) Nominal dimension including rails

Reference: JEM Payload Accommodation Handbook Vol. 8 D

https://iss.jaxa.jp/kibouser/library/item/jx-esp_8d.pdf

The CubeSat orbit deployer is configured to meet the CubeSat standard.

2. Introduction to CubeSat

2.1. What is CubeSat? : Constraints on CubeSat (Constraint on Payload)

- ❏ A CubeSat, must conform to specific criteria that control factors such as its shape, size, and weight.
- ❏ Equipment cannot be mounted outside of the CubeSat orbit deployer envelope.
- ❏ The electrical power must be turned off before orbit insertion and turned on after insertion.
- ❏ These constraint affects the size, weight, shape and operation of the payload.

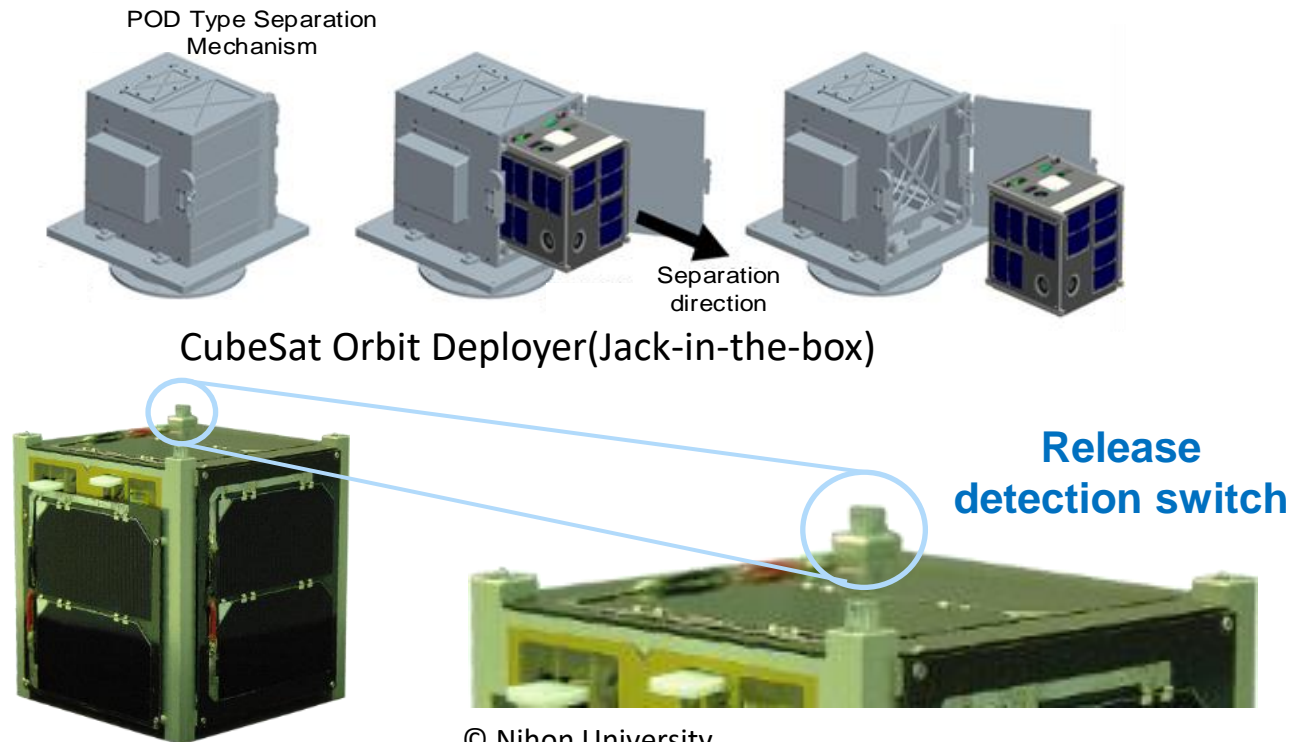

© Nihon University



© JAXA

2. Introduction to CubeSat

2.1. What is CubeSat? : Hold & Release Mechanism(HRM) & deployable structure

- ❖ The size, weight, and shape constraints affect the size, weight, and shape of the payload.
- ❖ However, if a hold-and-release mechanism is installed, the solar panels and deployable sensors can be held before release and deployed after release into orbit, triggered by a signal from the CubeSat.

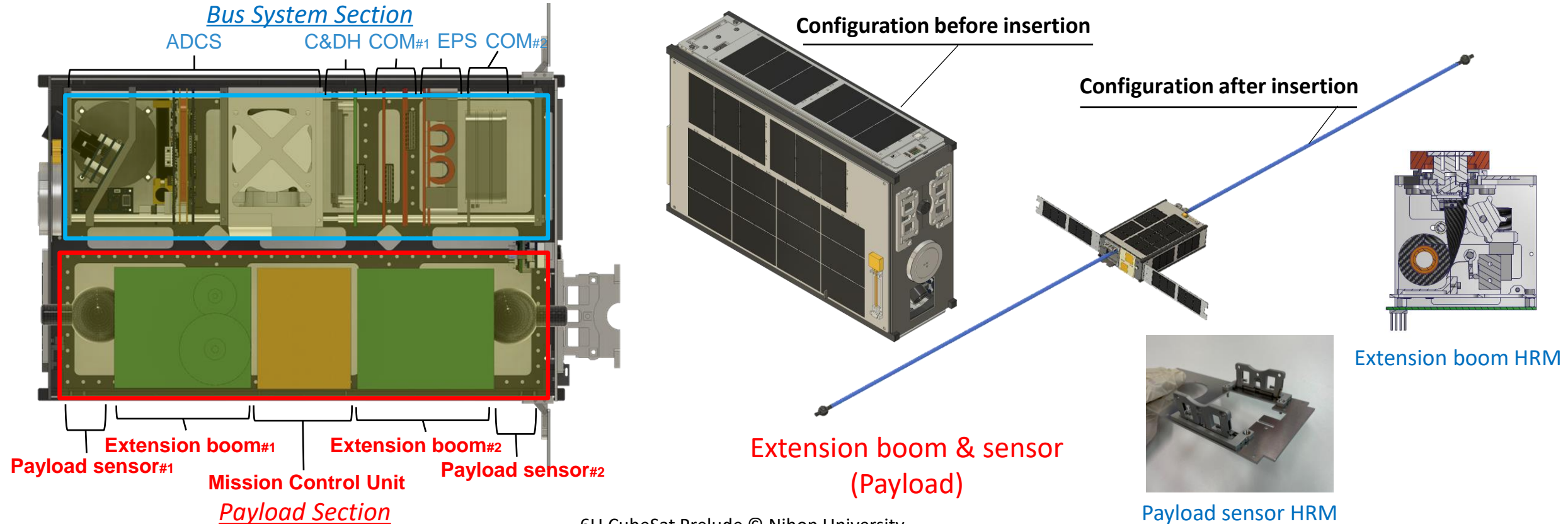

6U CubeSat Prelude © Nihon University

2. Introduction to CubeSat

2.1. What is CubeSat? : Hold & Release Mechanism(HRM) & deployable structure

- ❏ Before the CubeSat is released into orbit, these deployables need to be constrained.
- ❏ The most common method of constraint is to tie a fishing line to the component and pass the other end by a simple resistor such as nichrome wire.
- ❏ When a current is applied to the resistor and the resistor heats up sufficiently, the fishing line melts and the expanded product is released.
- ❏ HRM and deployable structures are one way to change the shape of a CubeSat on orbit while preserving the CubeSat's constraints at launch.

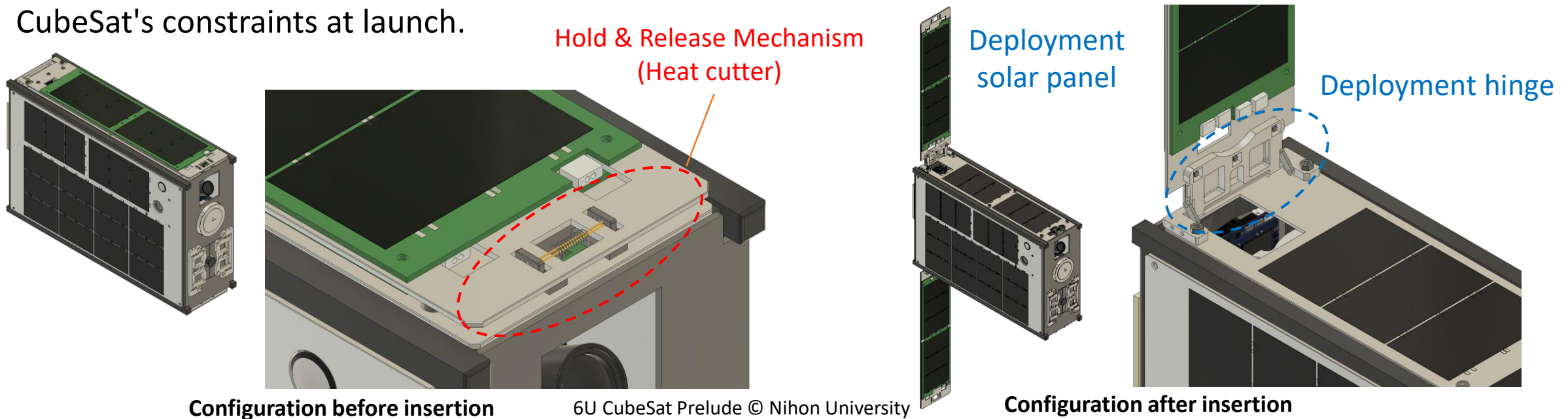

2. Introduction to CubeSat

2.1. What is CubeSat? : Hold & Release Mechanism(HRM) & deployable structure

Example: Convex deployment antenna of OrigamiSat

- ✓ Wrap the two phosphor bronze convex-tape antennas around the satellite structure.
- ✓ Shorter antenna (430 MHz) is wrapped first, followed by the longer antenna (145 MHz) wrapped on top of it.
- ✓ Restrain the tip of the 145MHz antenna with Vectran® threads, fixed to the satellite body.
- ✓ Burn threads with nichrome wires.

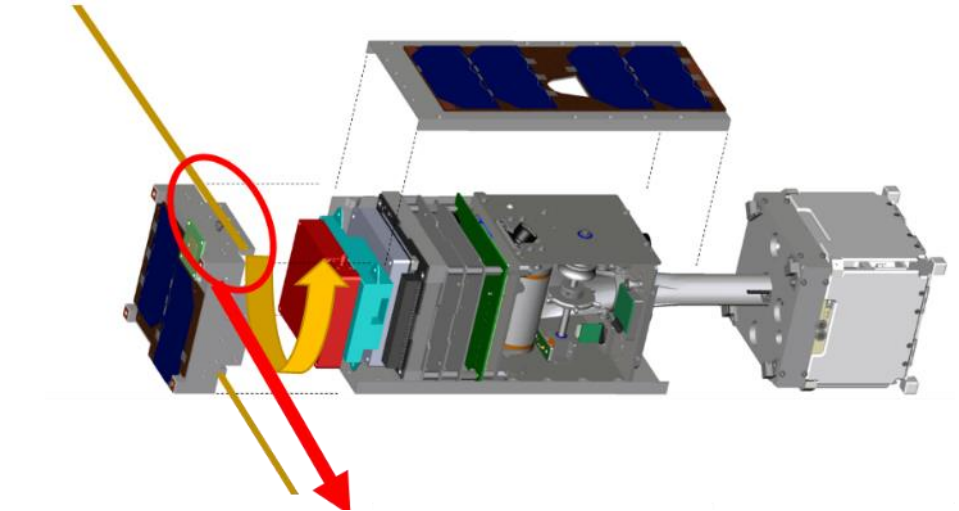
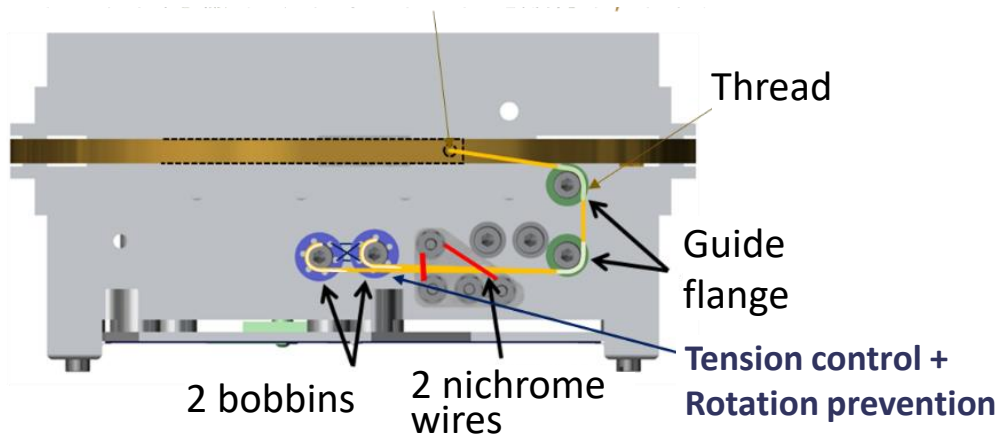

Stored configuration

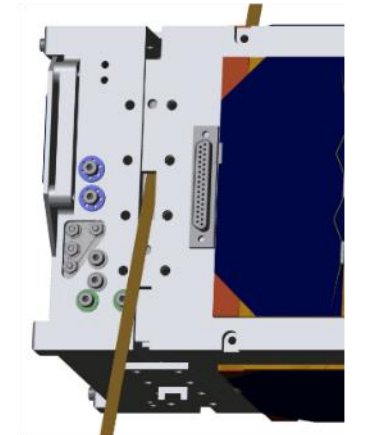

Deployed configuration

3U CubeSat Origami-Sat ©Tokyo Institute of Technology



3. Introduction to CubeSat Systems

3. Introduction to CubeSat Systems

3.1. What is CubeSat System? : Component/Subsystem/Interface/ System

- System is a combination of hardware, software, people, data, services, and many other elements that work together to achieve a goal.

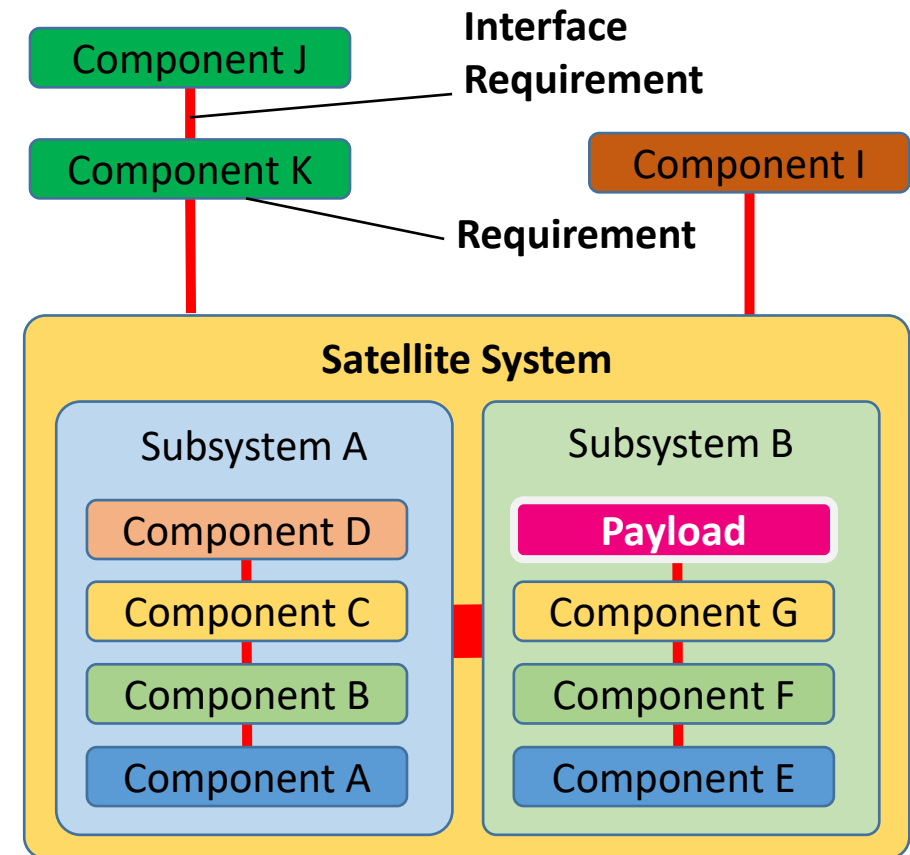
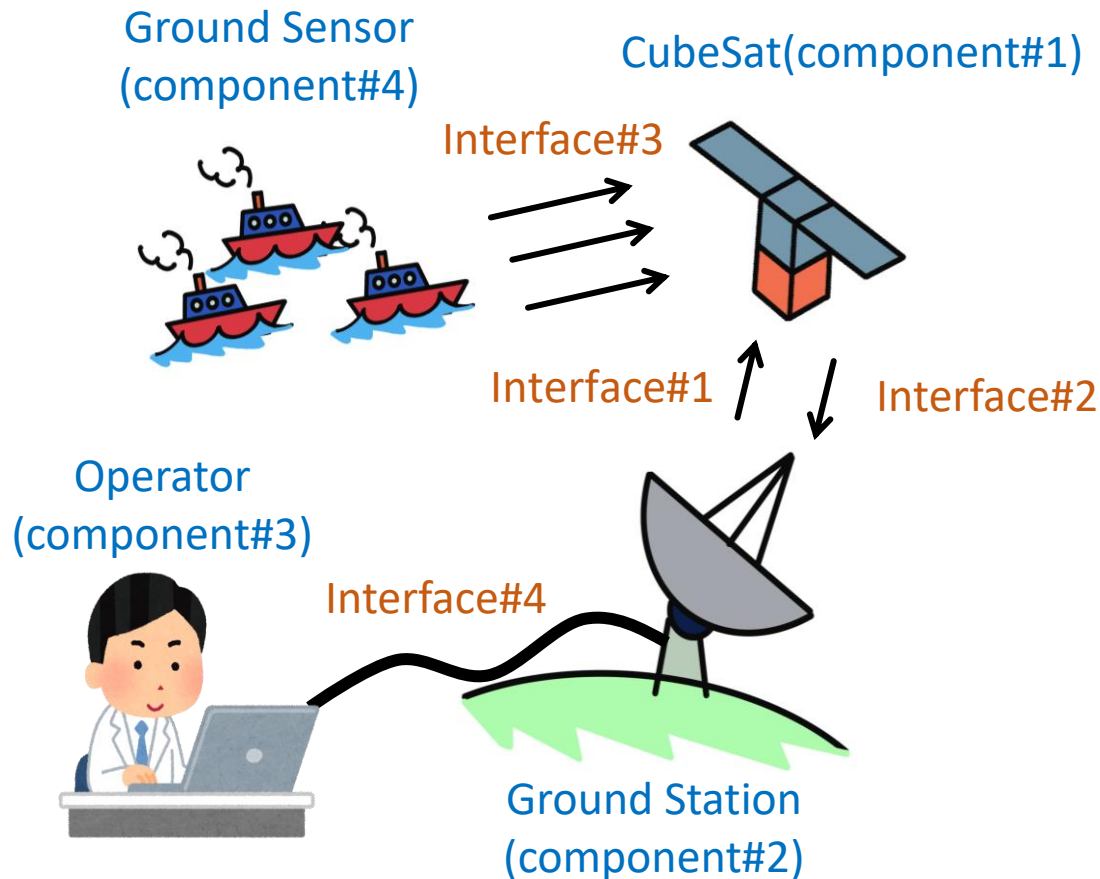

3. Introduction to CubeSat Systems

3.1. What is CubeSat System? : Bus system & Payload system

- ❏ The CubeSat system consists of a payload and a bus system.
- ❏ The CubeSat bus system can be divided into several subsystems.
 - ❏ Power control system, communication system, command & data handling system, structure and mechanism system, thermal control system, attitude control system, orbit control system, etc.

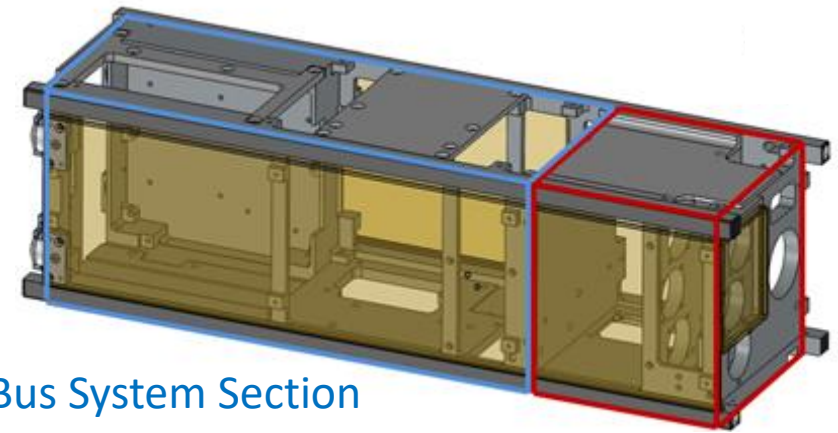
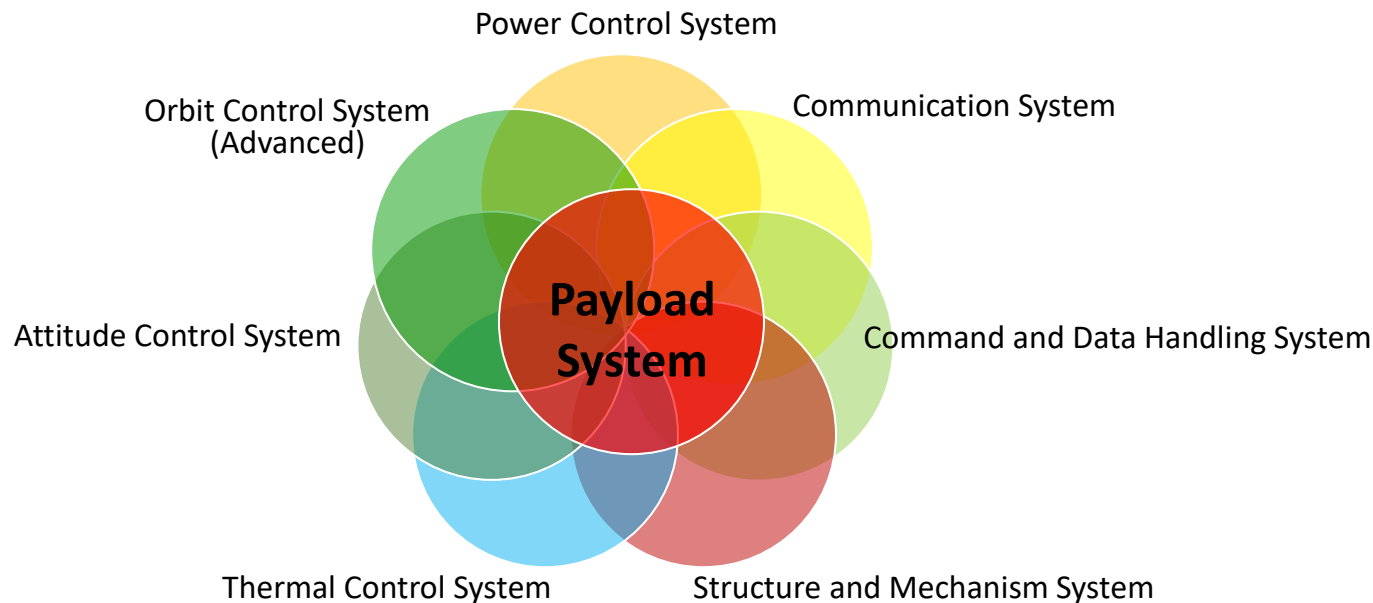

3U CubeSat S-CUBE © Chiba Institute of Technology / Tohoku University

Payloads do not operate by themselves, but rather demonstrate their capabilities in combination with other on-board hardware, software, and interfaces.

3. Introduction to CubeSat Systems

3.1. What is CubeSat System? : Constraints on CubeSat (Constraint on Payload)

- ❖ CubeSat resources (power, space, etc.) must be allocated to maintain bus functions for power generation, storage, management, thermal control, communications (sending information to Earth), attitude determination and control, and data processing.

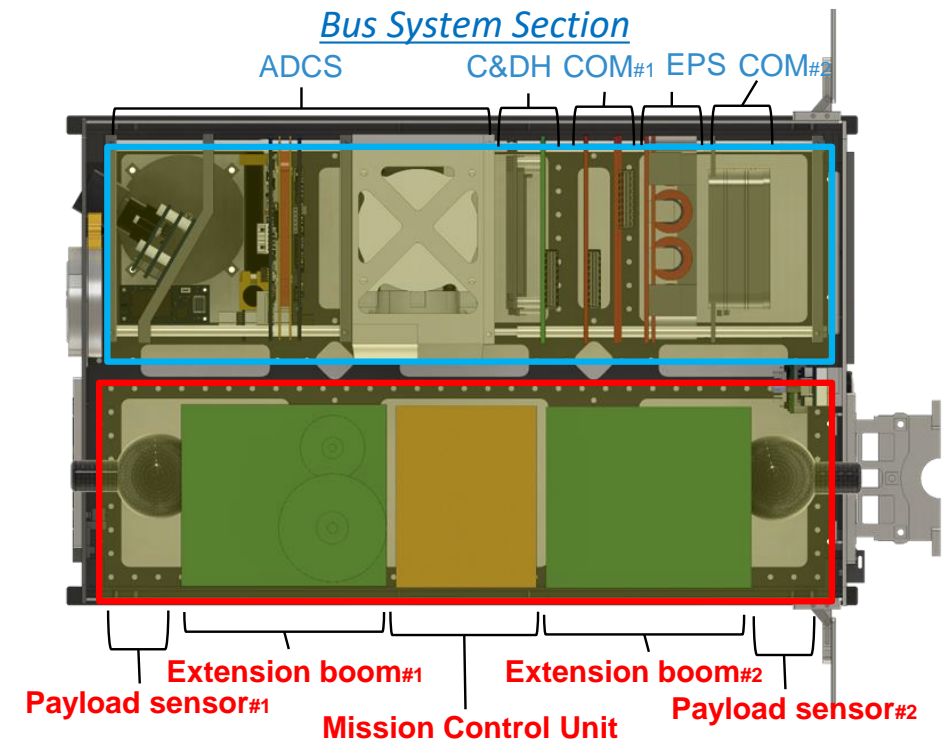
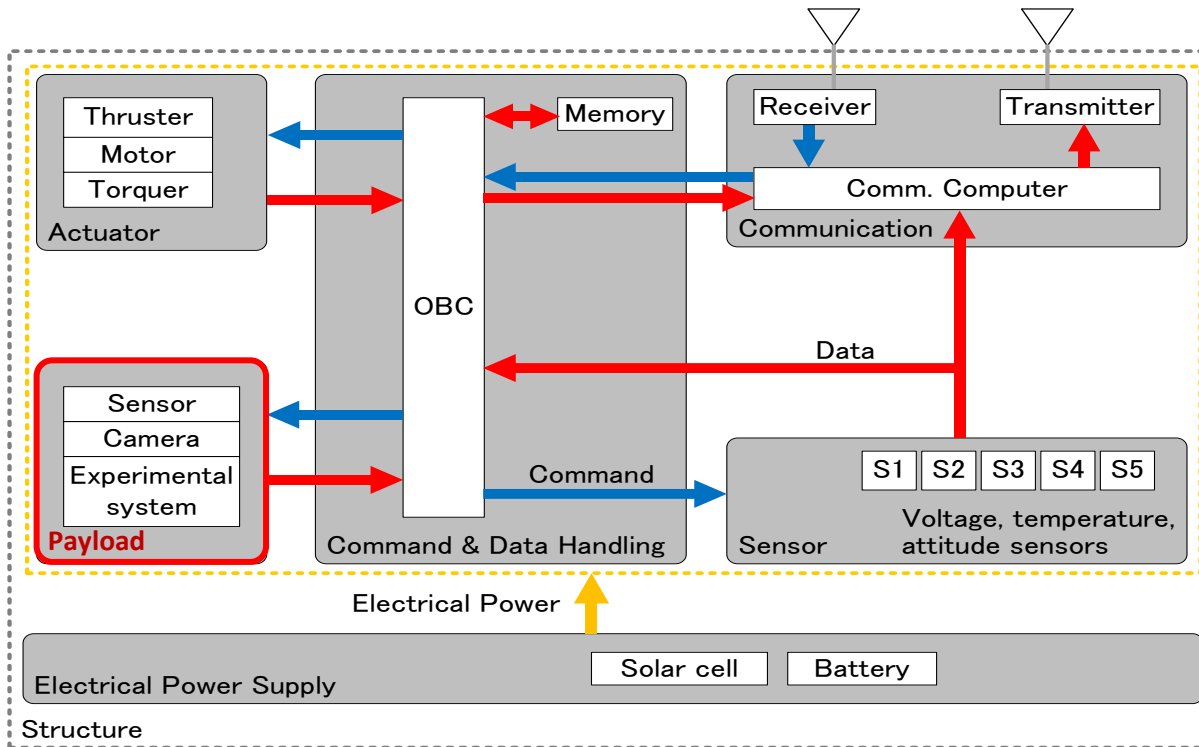

6U CubeSat Prelude © Nihon University

The power, space, mass and data available for payloads are limited.

3. Introduction to CubeSat Systems

3.1. What is CubeSat System? : Relationship of Payload and Bus System

- ❏ Larger, high-performance bus systems will be required for high-level missions.
 - ❏ Higher power generation, storage capability => Large solar panels area and more battery capacity
 - ❏ Higher data processing capability, more memory storage, higher communication throughput.
 - ❏ Accurate attitude determination and control capability.
 - ❏ Large component mount capability
- ❏ The size of the CubeSat for each mission shall be carefully selected based on the difficulty level of the mission objective and the complexity of the requirements on payload instruments.
- ❏ The larger and the more complex the system is, the more effort will be required for the system integration. (Number of element and number of interface are increase.)

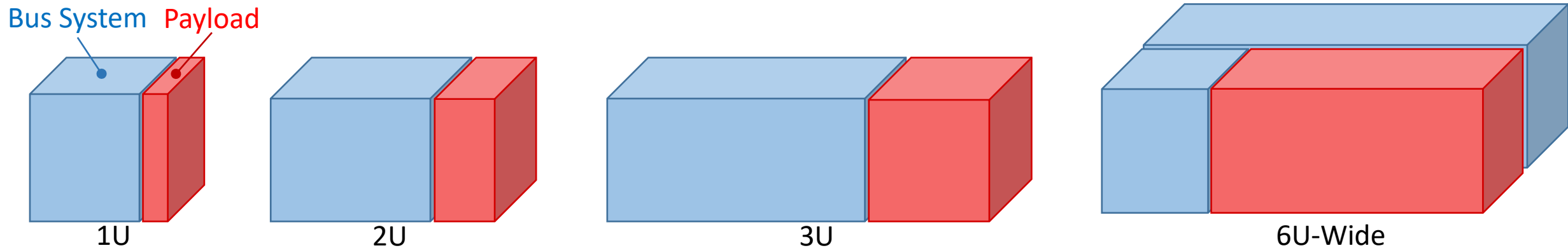



4. Types of Payload Systems & Examples of CubeSat mission

4. Types of Payload Systems & Examples of CubeSat mission

4.1 Types of Payload Systems:

❖ Earth observation

- ❖ Optical
- ❖ Hyperspectral
- ❖ multi-spectral
- ❖ Panchromatic, etc.

❖ Communication

- ❖ Unidirectional
- ❖ Two-way, etc.

❖ Meteoroids measurement

❖ Experiment inside a CubeSat

❖ In-situ space environment measurement

- ❖ magnetic field
- ❖ Electric field

❖ Technology demonstration

- ❖ Deployment mechanisms
- ❖ Advanced technologies (new sensors, electrodynamic tether, etc.)

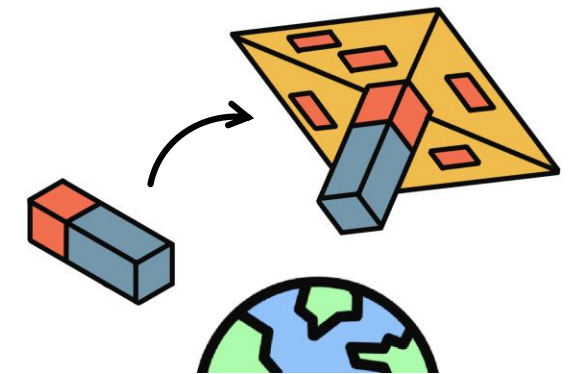
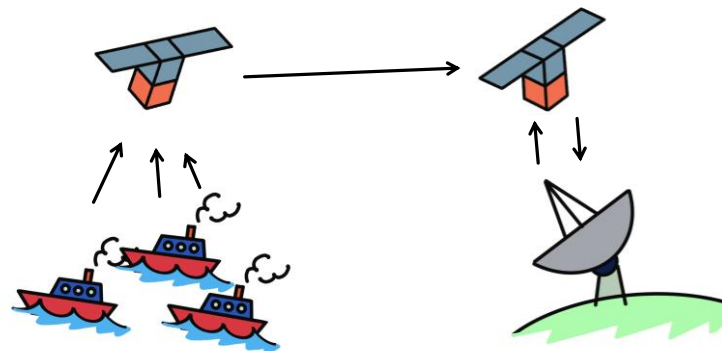
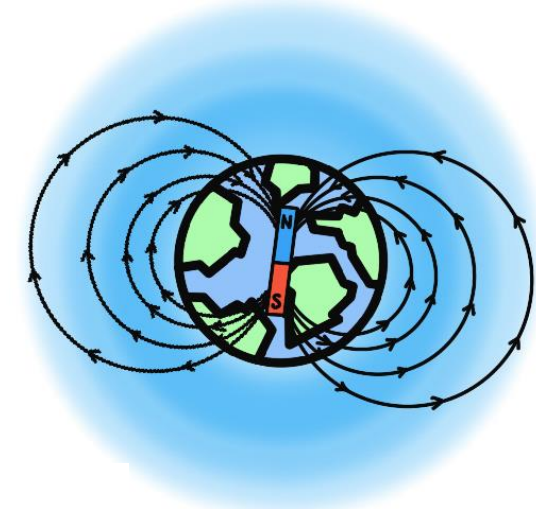
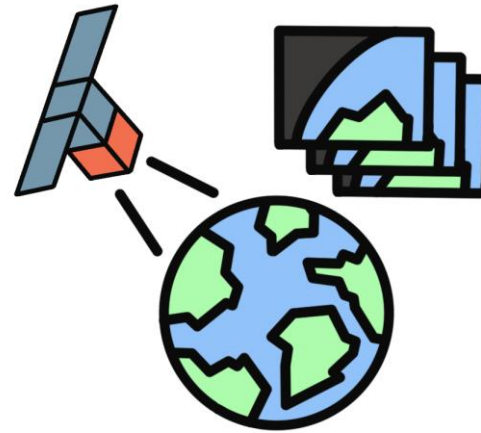

4. Types of Payload Systems & Examples of CubeSat mission

4.2 Earth observation

- ❏ The satellite is in orbit to “observe” something that is on Earth.
 - ❏ Constructions, humidity levels, amount of vegetation, detecting spills into the sea, disaster, etc.
 - ❏ Each of these missions requires a different type of camera.
- ❏ **Resolution: 5m, 10m, 100m ?**
 - ❏ The higher the resolution, the larger the camera and satellite size.

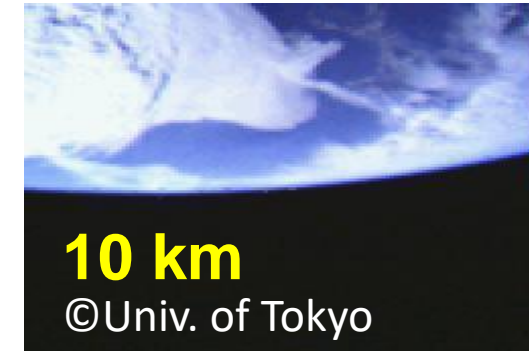
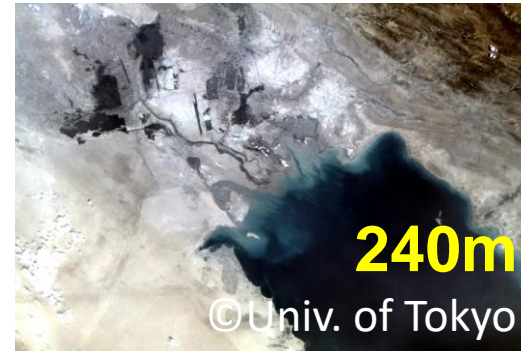

- ❏ **Wavelength: red, green, blue, red edge, near infrared....**
 - ❏ Optical, hyperspectral, multi-spectral, panchromatic cameras, etc.
 - ❏ The difference between them is the type of observation that is made and the wavelength bands of the light you want to capture.

4. Types of Payload Systems & Examples of CubeSat mission

4.2 Earth observation: 1U CubeSat "XI-IV"

❖ **Earth observation:** Capturing and downlinking Earth photos

- ❖ Captured as many photos as possible and only photos which have Earth images were stored and downlinked.
- ❖ 1200 bps communication speed requires 3 - 4 days to downlink 1 photo.

❖ **Technology demonstration:** Realizing satellite bus functions for a certain period.

- ❖ "Satellite bus system functioning" in itself is a good mission if it is your first project.



1U CubeSat XI-IV © University of Tokyo



© University of Tokyo

4. Types of Payload Systems & Examples of CubeSat mission

4.3 Communication

- ❖ The satellite is in orbit to “collect” data and “send” data to the earth.
- ❖ Disaster prediction, water level monitoring, soil moisture, PH, AIS, etc.....
- ❖ Each of these missions requires a different type of communication, for example, **unidirectional systems** and **Two-way communication system** (such as Send or return messages/data or commands)

unidirectional system

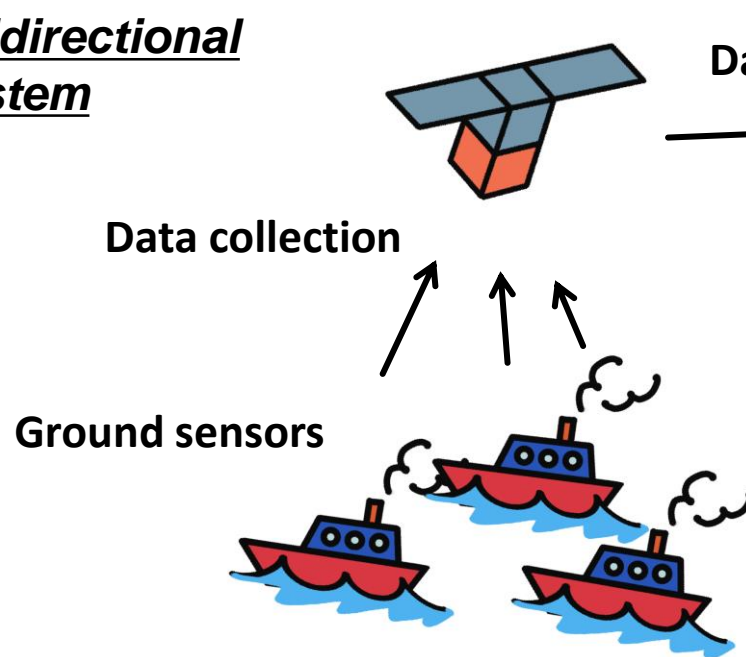

Two-way communication system

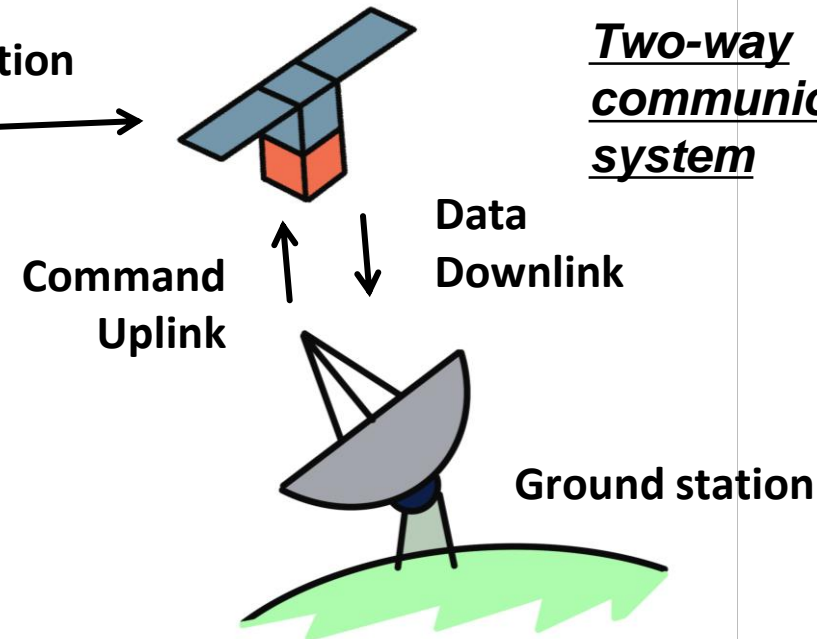

4. Types of Payload Systems & Examples of CubeSat mission

4.3 Communication: 3U CubeSat

- ❖ **Communication:** AIS (Automatic Identification System) signal receiver, Deployable directional antenna
- ❖ A 3-axis attitude control is utilized to point the antenna toward the Earth for detecting AIS signals sent from ships, enabling tracking the positions of the ships with a higher geographical resolution.

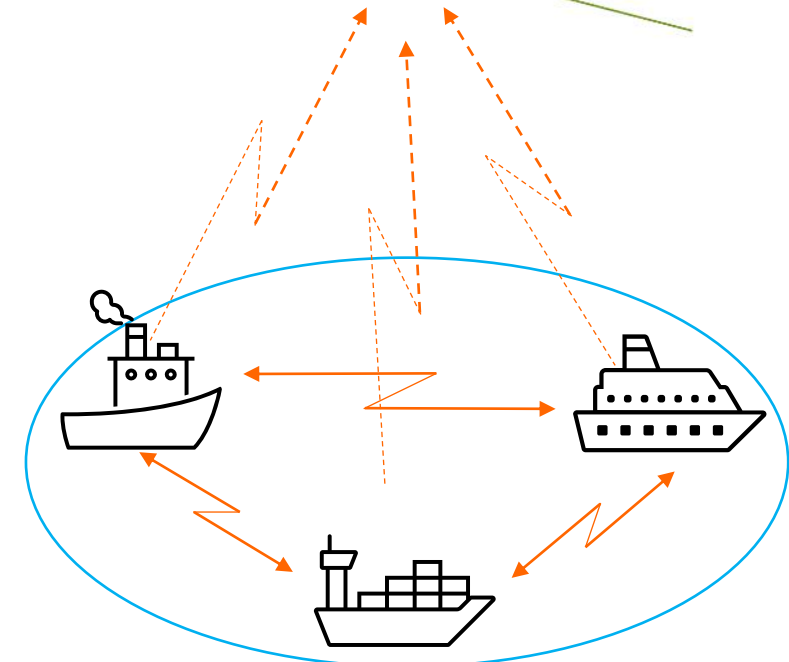
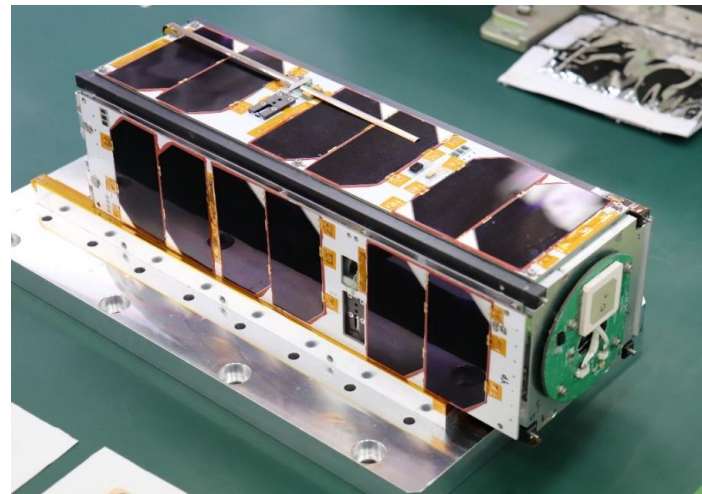
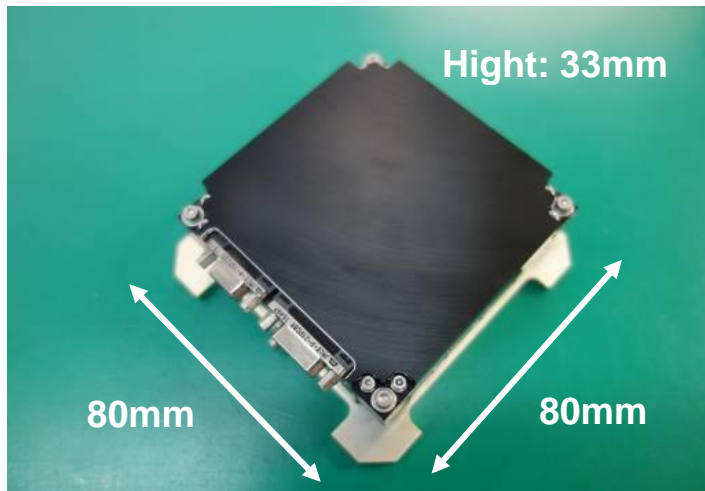
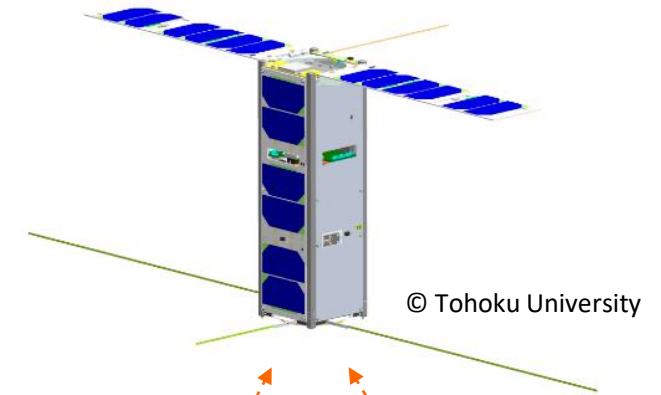

© Tohoku University

4. Types of Payload Systems & Examples of CubeSat mission

4.4 Meteoroids measurement: 6U CubeSat Payload DELPHINUS

- ❖ The satellite is in orbit to “observe” meteoroid that is in space.
- ❖ **Meteoroids measurement** : Detection camera for Lunar impact Phenomena in 6U Spacecraft
- ❖ When a meteoroid with a diameter of several centimeters to several tens of centimeters impacts the lunar surface, a Lunar Impact Flash (LIF) is produced in the visible to near-infrared wavelength range which can be observed by ground-based telescopes as a magnitude 5 to 11 short duration, 0.01 to 0.1 seconds, flash.

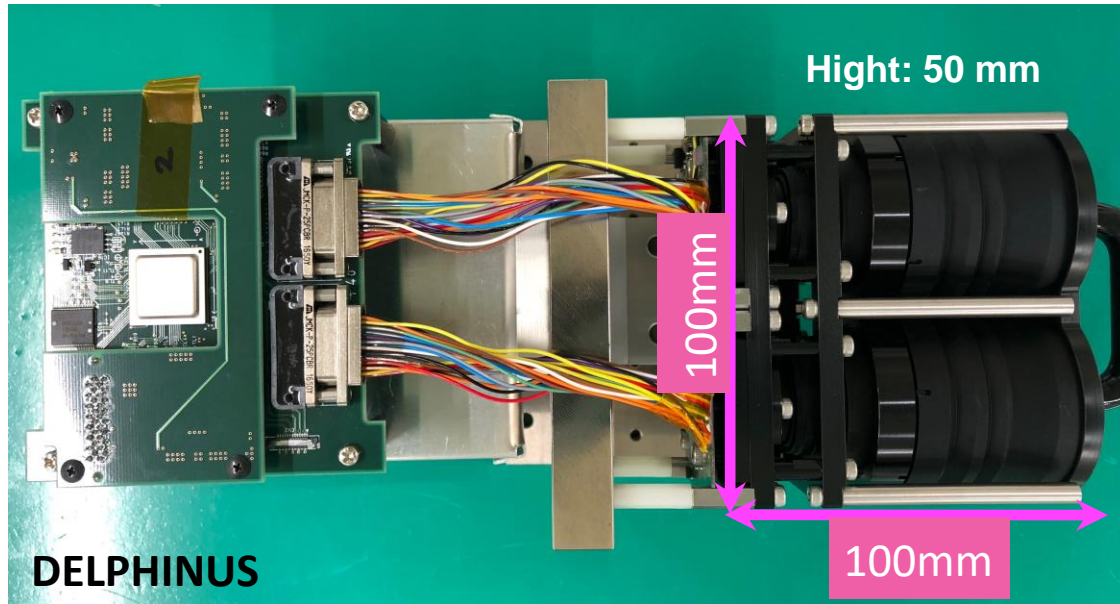

© Nihon University, University of Electro-Communications, University of Tokyo, JAXA

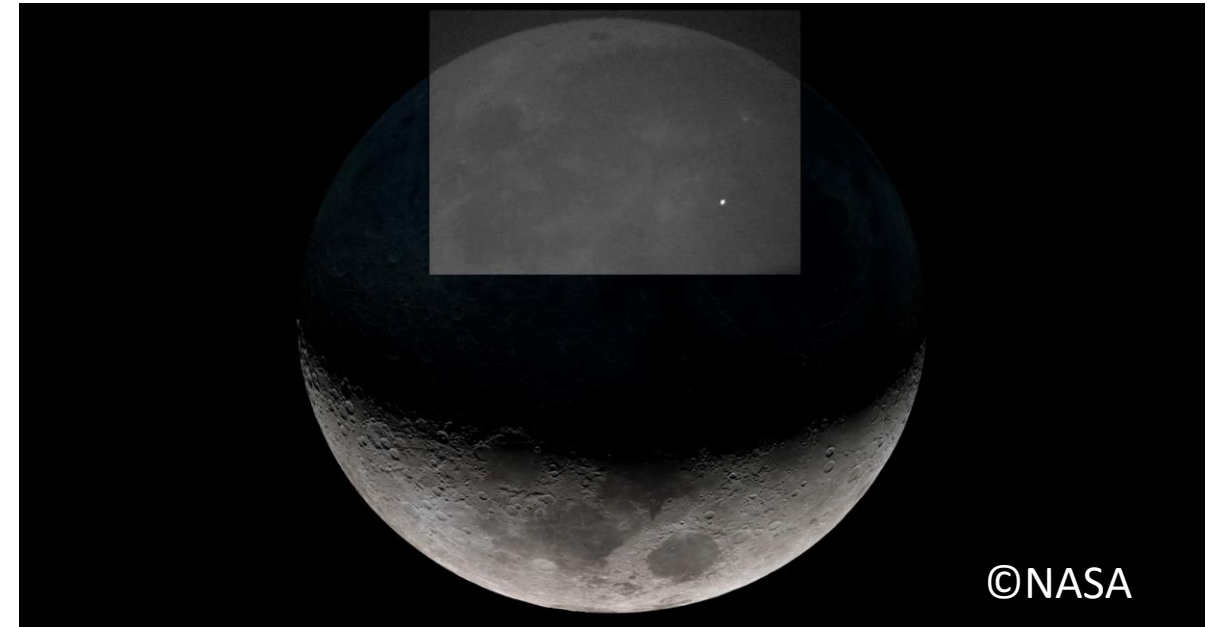

4. Types of Payload Systems & Examples of CubeSat mission

4.4 Meteoroids measurement: 3U CubeSat "S-CUBE"

❖ **Meteoroids measurement:** Meteor Observation Camera System, Gravity Gradient Boom, Deployable Solar Panels

- ❖ A gravity gradient boom was used to point the meteor observation camera toward the Earth's atmosphere for detection of incandescent meteors as they enter the atmosphere.

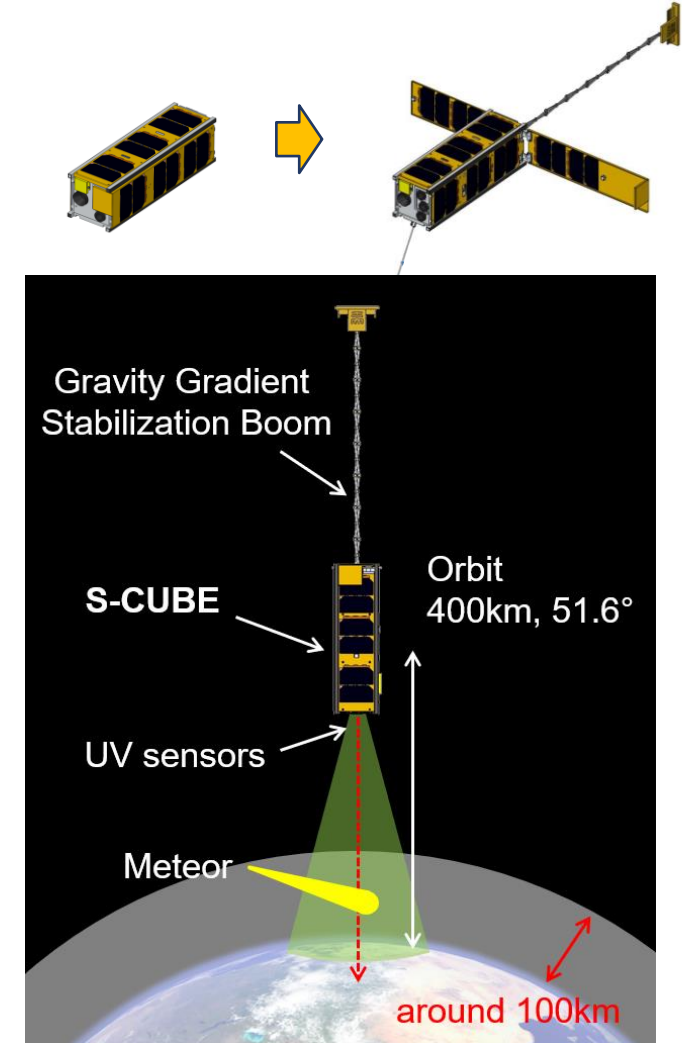
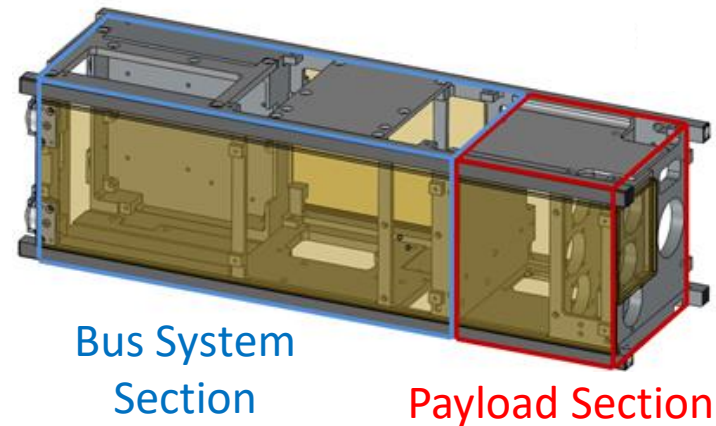
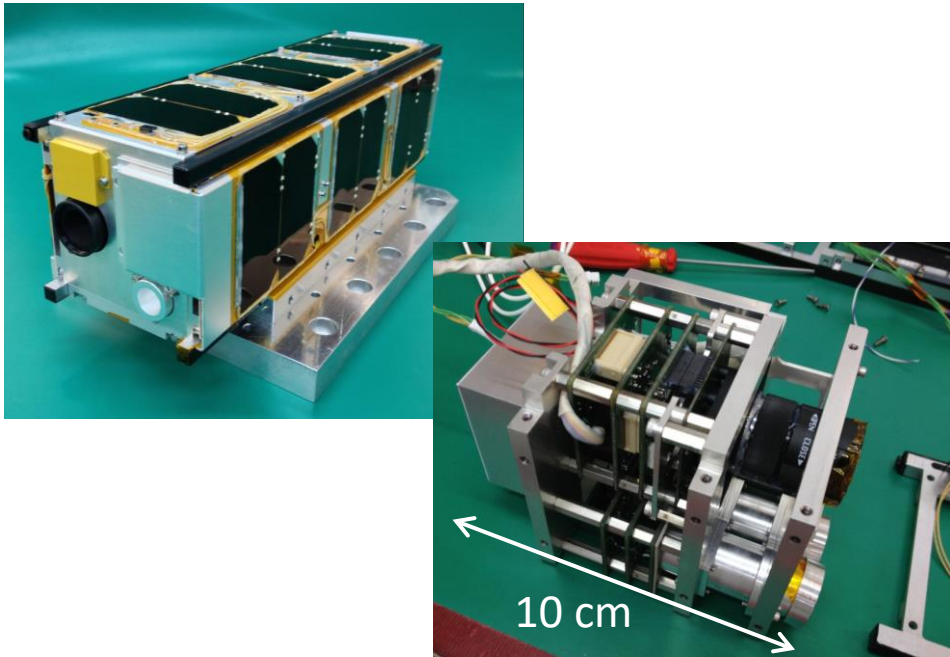

3U CubeSat S-CUBE © Chiba Institute of Technology / Tohoku University

4. Types of Payload Systems & Examples of CubeSat mission

4.5 Experiment inside a CubeSat

- ❏ The satellite is in orbit to “use” space environment.
- ❏ The unique environment provided by space, including microgravity, vacuum, high radiation, intense ultraviolet radiation, low and high temperatures, and the presence of atomic oxygen and plasma, can be used for variety of experiments in materials science, bioscience, and medical science.

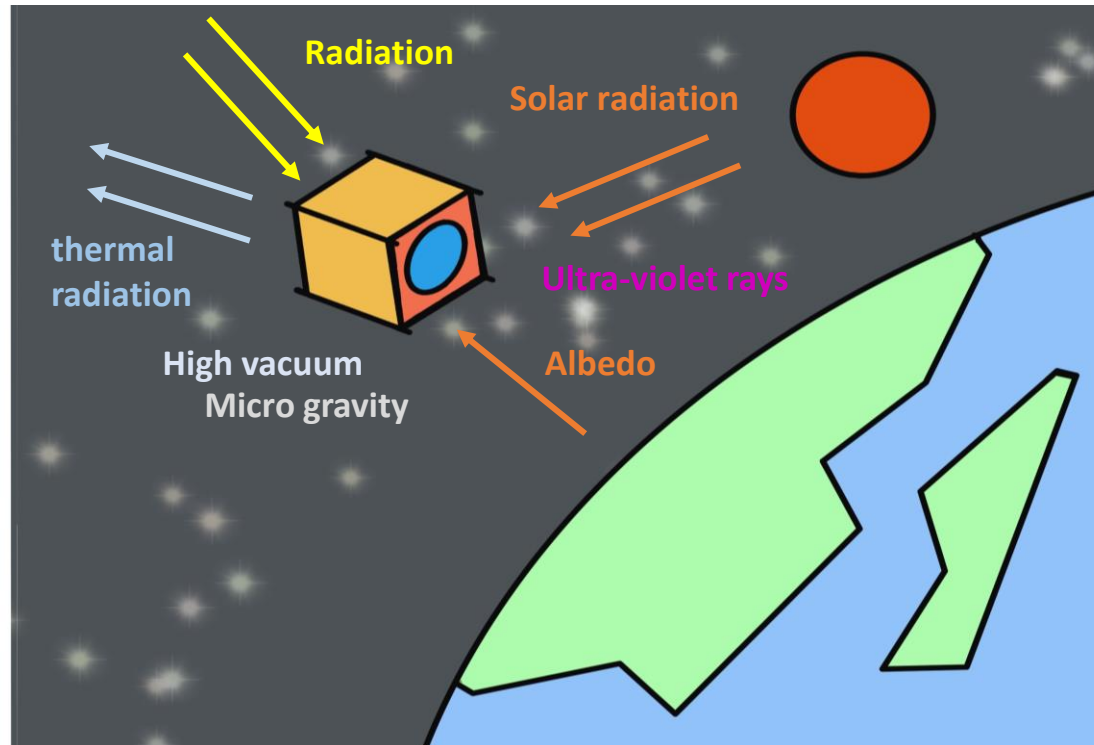

4. Types of Payload Systems & Examples of CubeSat mission

4.5 Experiment inside a CubeSat : 6U CubeSat "Ten-koh2"

- ❖ **Experiment inside a CubeSat** : Observation of space environment resistance of advanced space materials.
- ❖ **In-situ space environment measurement**: Observation of the global environment using a high-resolution camera, Geospace observation using a high-energy charged particle detector.

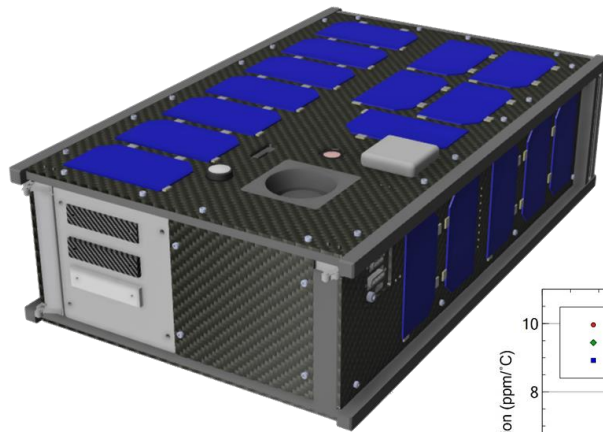

6U CubeSat Ten-koh2
© Nihon University

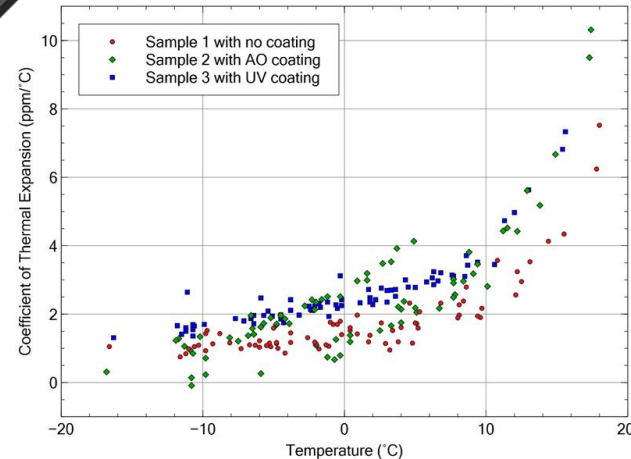

Assembly design

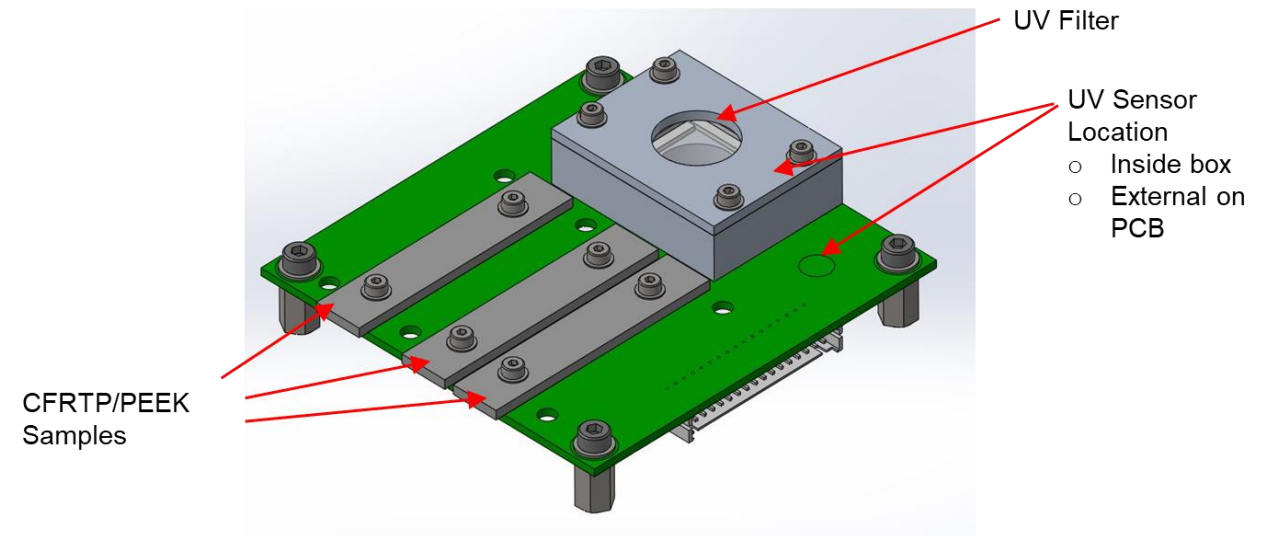

4. Types of Payload Systems & Examples of CubeSat mission

4.6 In-situ space environment measurement

- ❏ The satellite is in orbit to 'measure' in-situ phenomena.
 - ❏ In-situ plasma, particle, magnetic field, electric field, atmospheric drag, etc.
 - ❏ Observe these physical quantities "in-situ" where the phenomena are occurring, and elucidate the physical processes behind the phenomena. Also, to understand phenomena that occur in places that cannot be visited directly (distant celestial bodies and the ionosphere).

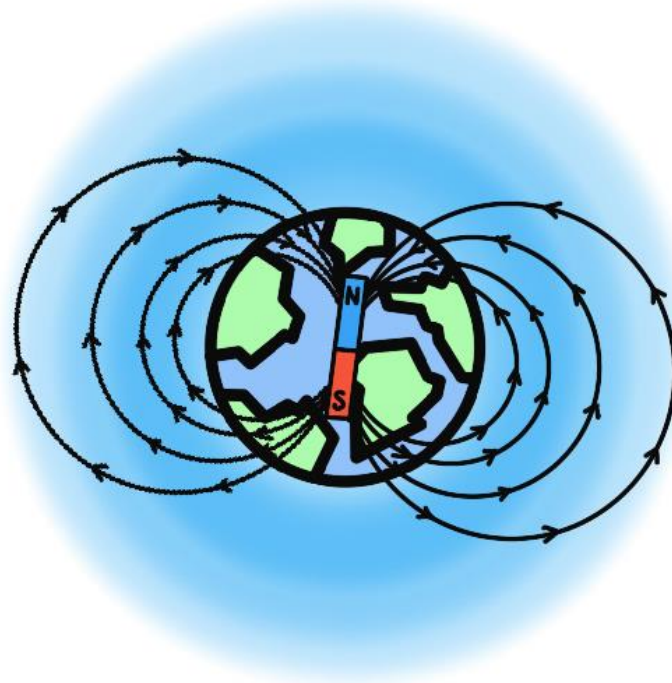

4. Types of Payload Systems & Examples of CubeSat mission

4.6 In-situ space environment measurement : 1U CubeSat “SEEDS-II”

- ❏ **In-situ space environment measurement : Temperature, Geomagnetism sensor**
- ❏ **Communication** : Communication by Digi-talker (voice reproduction device)
- ❏ **Technology demonstration**: Realizing satellite bus functions for a certain period.
 - ❏ “Satellite bus system functioning” in itself is a good mission if it is your first project.

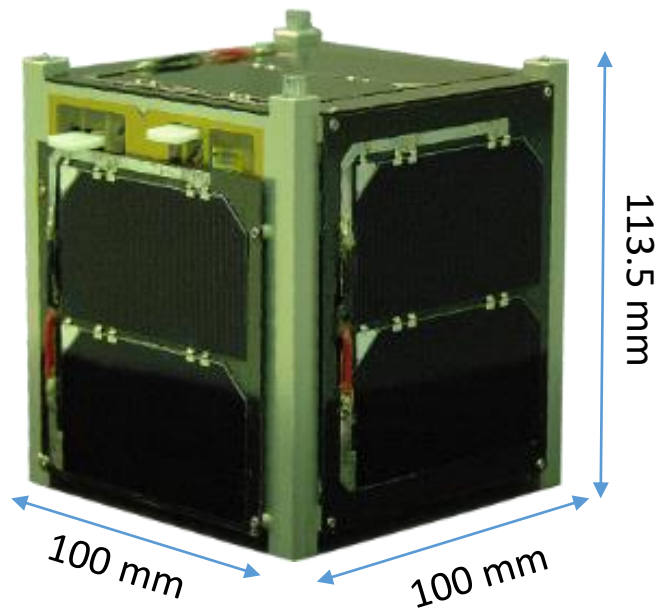

1U CubeSat SEEDS-II © Nihon University

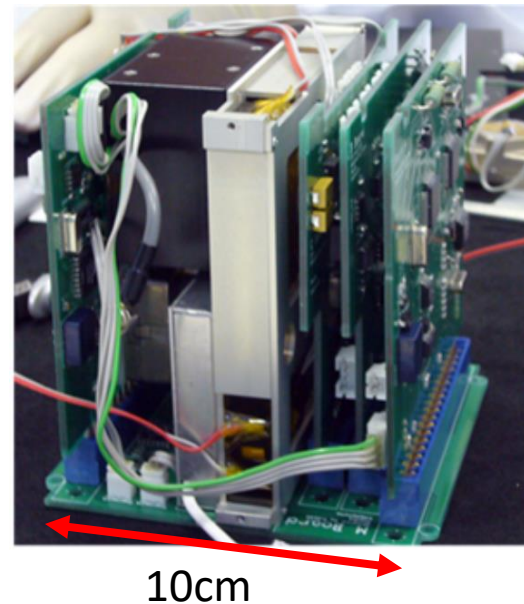

When the transmitter is turned on, high-frequency noise is added to the magnetic sensor.

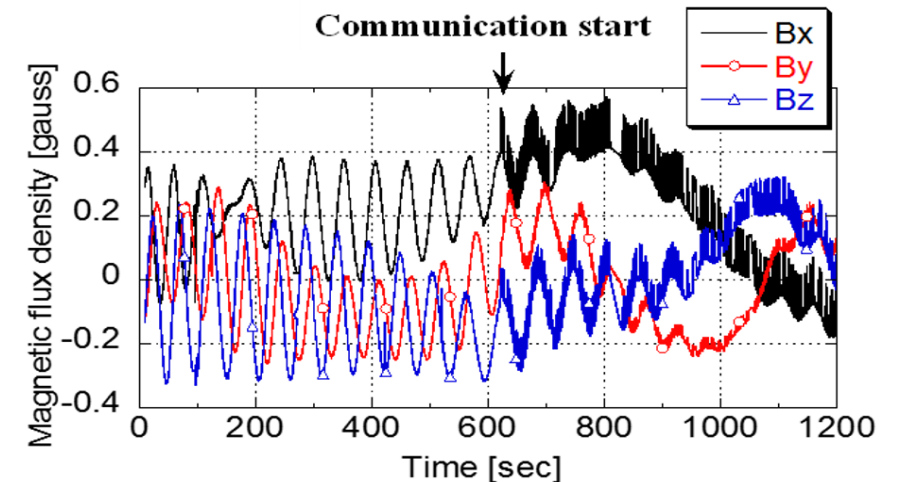

Configuration and Operation need to be considered.

4. Types of Payload Systems & Examples of CubeSat mission

4.6 In-situ space environment measurement : W6U CubeSat "Prelude"

❏ In-situ space environment measurement: Electric field probe and Langmuir probe

- ❏ The 6U CubeSat "Prelude" is aimed at verifying the reduction of radio wave intensity 4 hours before earthquakes by installing only one pair of electric field probes.
- ❏ Measuring the electric field intensity from the potential difference between two probes

Bus System Section

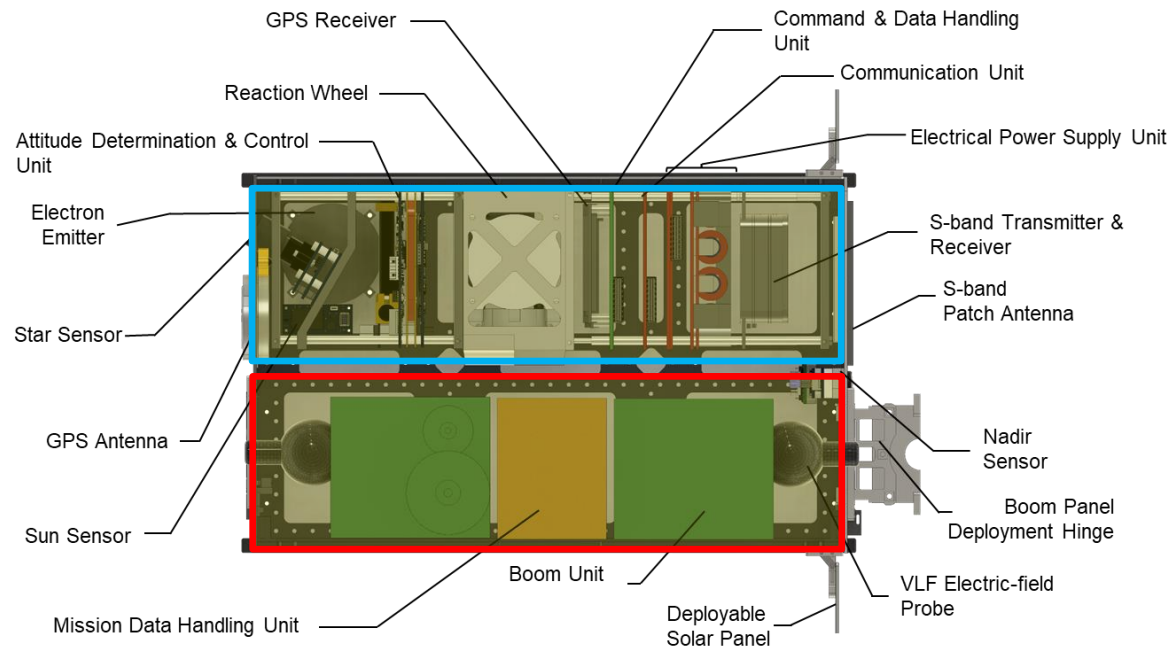

Payload Section

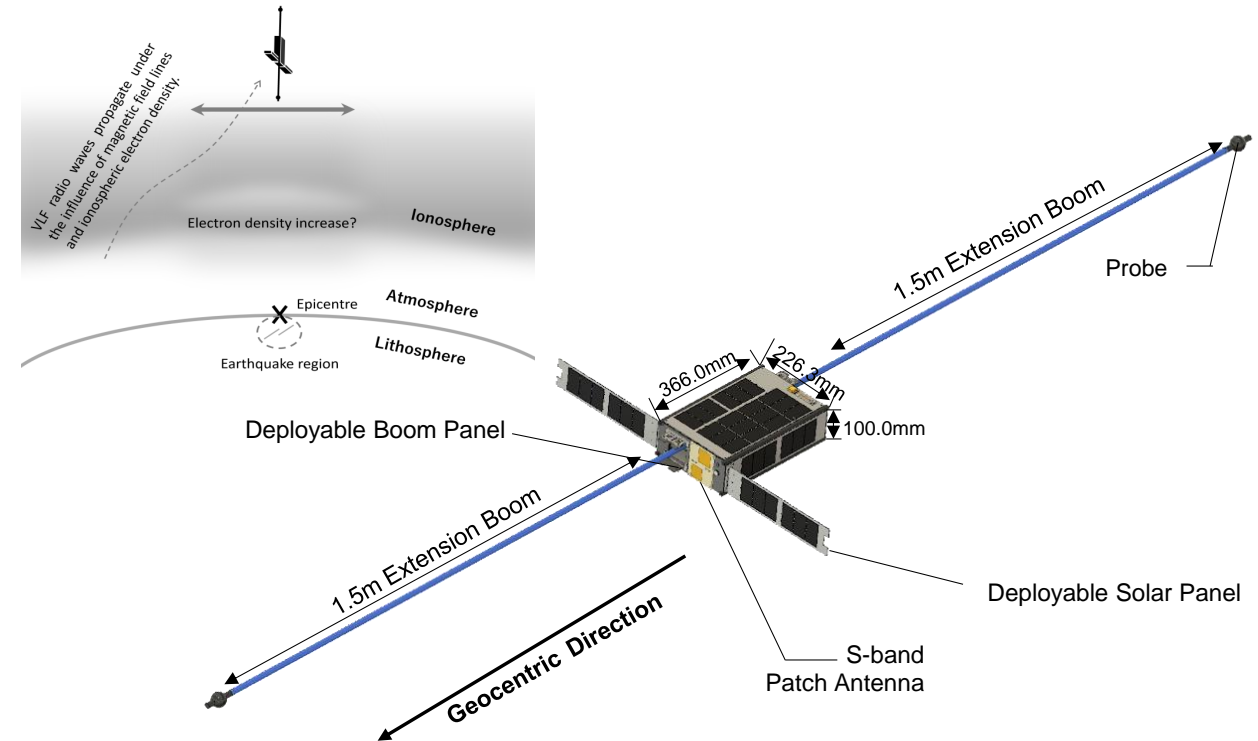

6U CubeSat Prelude © Nihon University

4. Types of Payload Systems & Examples of CubeSat mission

4.6 In-situ space environment measurement : W6U CubeSat "Prelude"

❏ In-situ space environment measurement: Electric field probe and Langmuir probe

- ❏ A 3-axis attitude control is utilized to point the probe toward the Earth for observing electric field intensity.
- ❏ During the daytime, a large amount of observation data is downlinked, and during the eclipse when there is little ionospheric disturbance, the attitude is controlled and the electric field intensity is observed.
- ❏ Understand phenomena that occur in the ionosphere, which cannot be visited directly

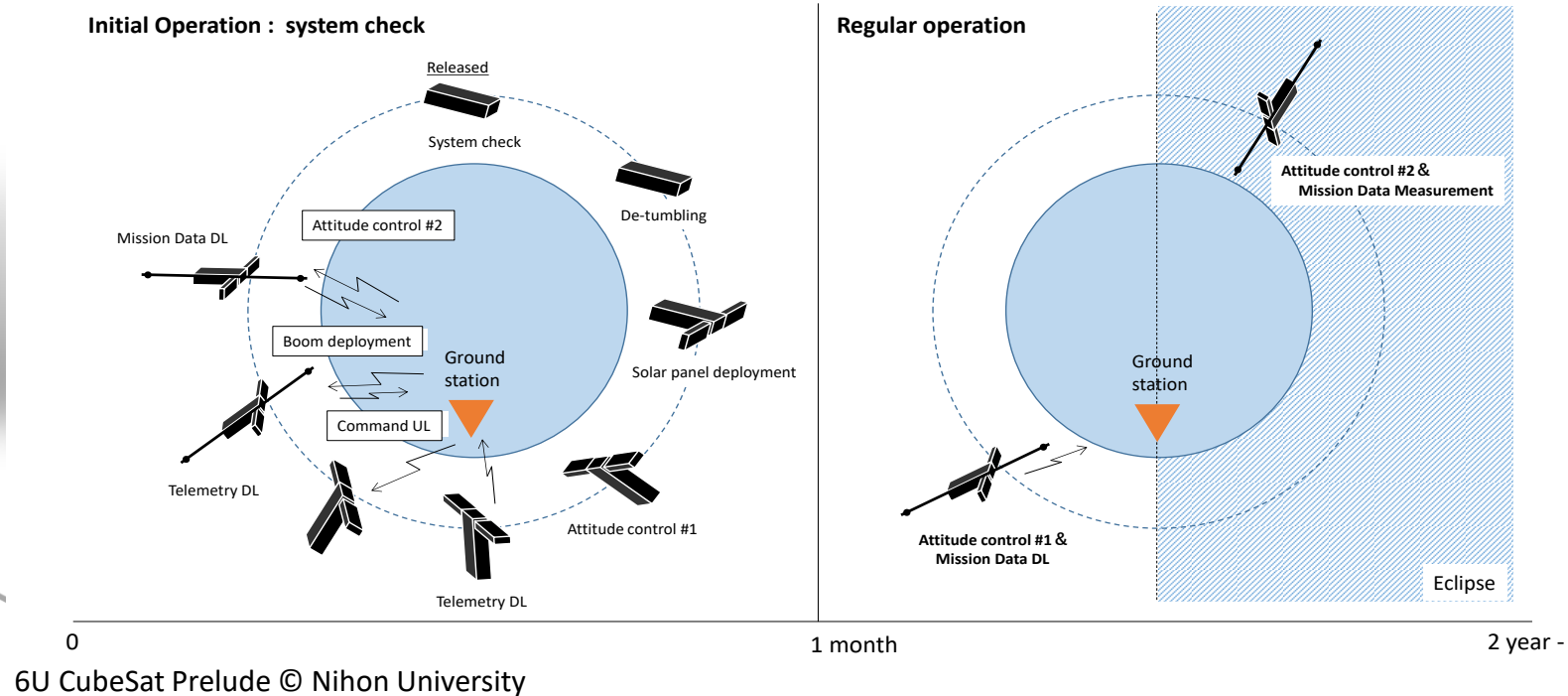
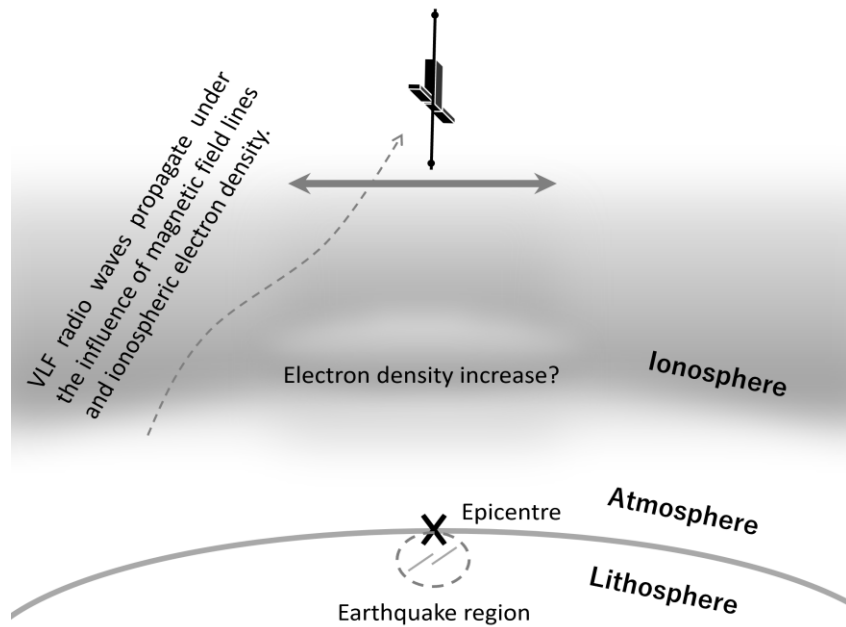

4. Types of Payload Systems & Examples of CubeSat mission

4.7 Technology demonstration

- ❖ The satellite is in orbit to 'see' how a certain technology behaves in space.
 - ❖ New sensor, communication instrument, structure and power generated instrument, etc.

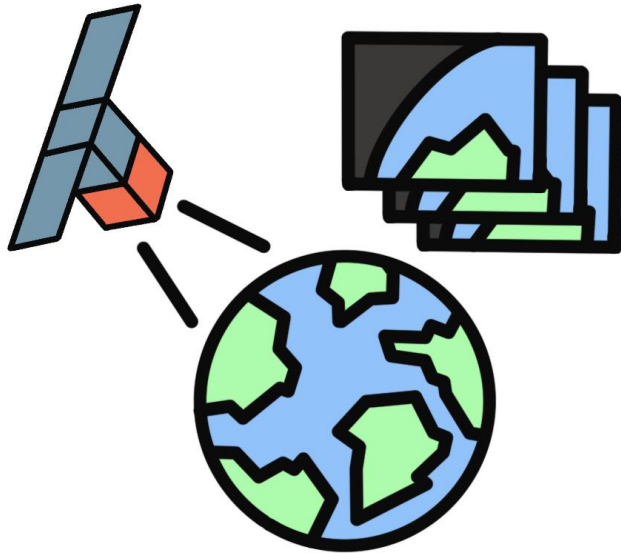

to take images = new Sensor to be engineering demonstrated

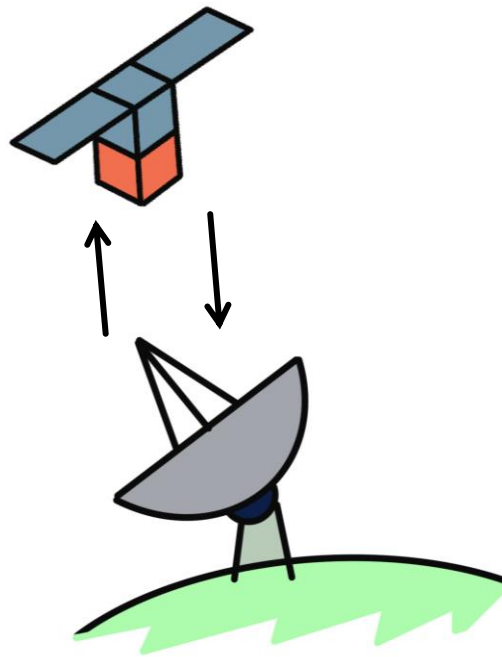

to receive, process and send information = new Communication Instruments to be engineering demonstrated

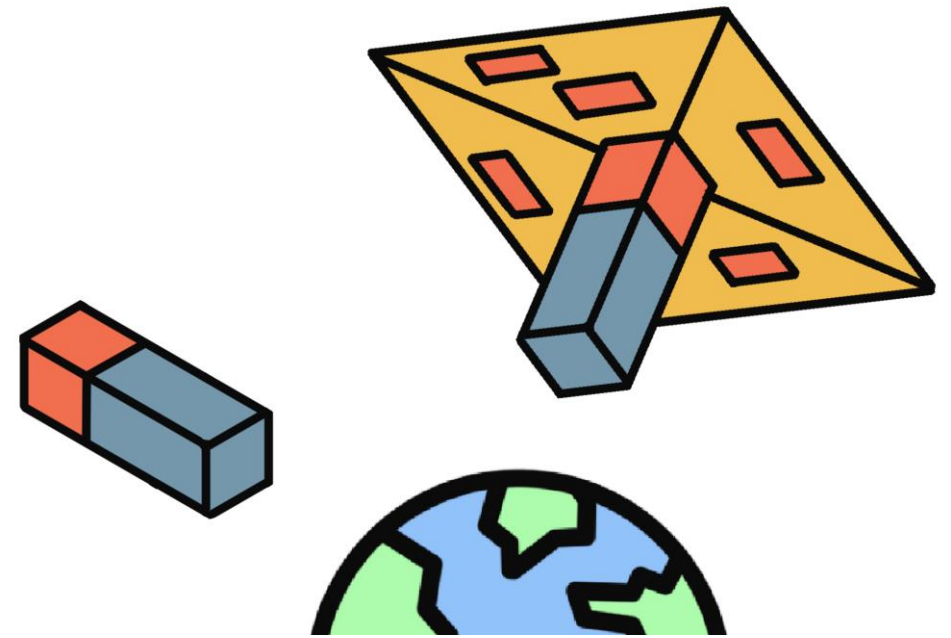

to see how a certain technology behaves in space = new component to be engineering demonstrated

4. Types of Payload Systems & Examples of CubeSat mission

4.7 Technology demonstration: 1U CubeSat "FREEDOM"

Technology demonstration : De-orbit sail for fast de-orbiting

- No communication system, no solar cells. FREEDOM demonstrated on-orbit deployment of the thin-film based de-orbit sail, which can be utilized for space debris mitigation and prevention using atmospheric drag.

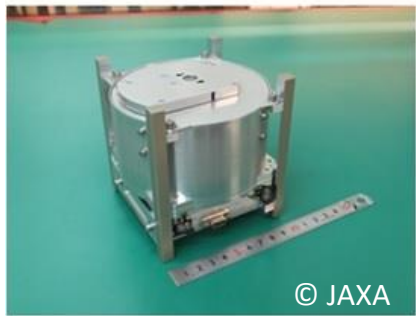

© JAXA

1U CubeSat FREEDOM
Nakashimada Engineering Works, Ltd.

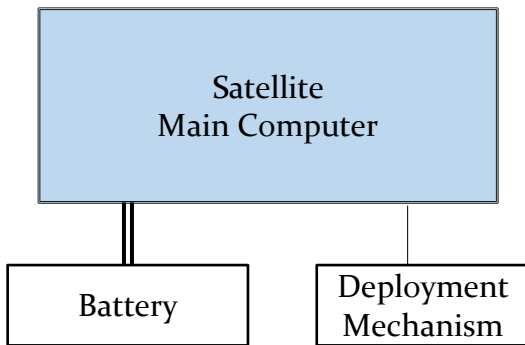

Implementation example of
1U CubeSat FREEDOM

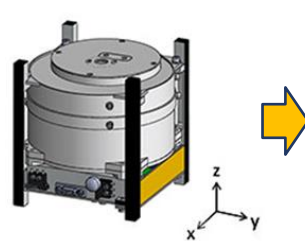
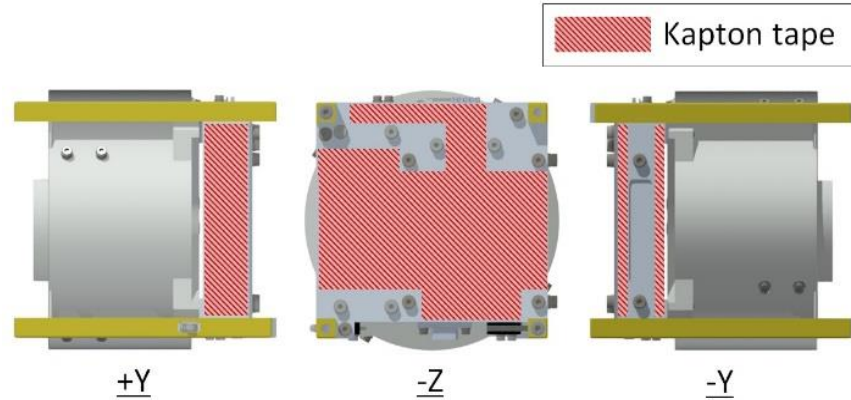
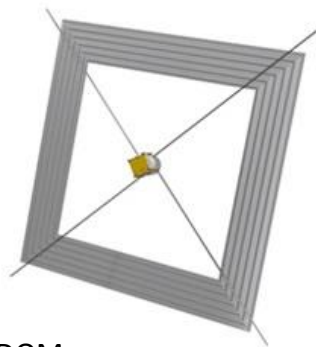

1U CubeSat FREEDOM © Nakashimada Engineering Works, Ltd. / Tohoku University

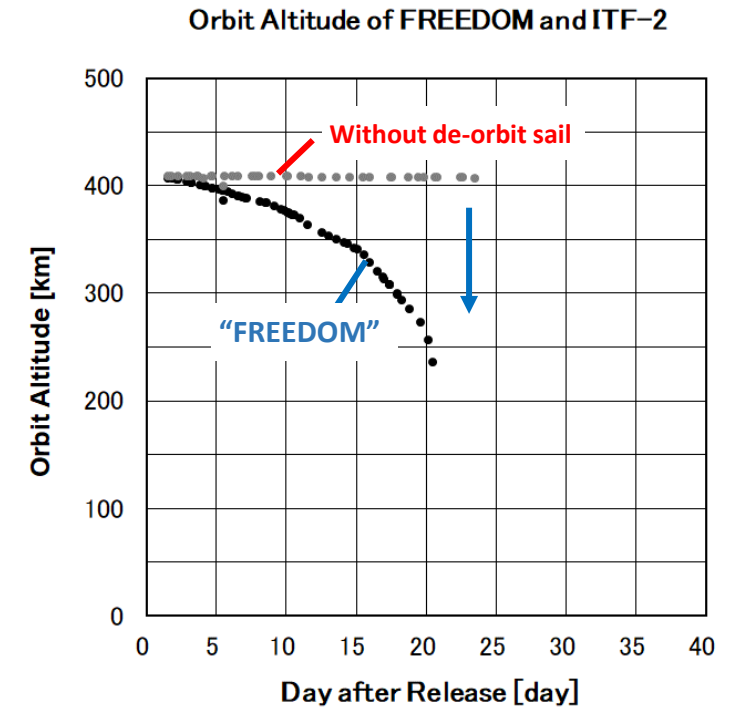

4. Types of Payload Systems & Examples of CubeSat mission

4.7 Technology demonstration: 3U CubeSat "Origami-Sat"

❖ Technology demonstration : multi-functional deployable membrane structure

- ❖ Deploy 1m x 1m membrane in space and obtain data about deployment dynamics and deployed shape.
- ❖ Measure the performance of thin-film devices on the membrane, such as thin-film solar cells and thin SMA (Shape-memory alloy) antennas.

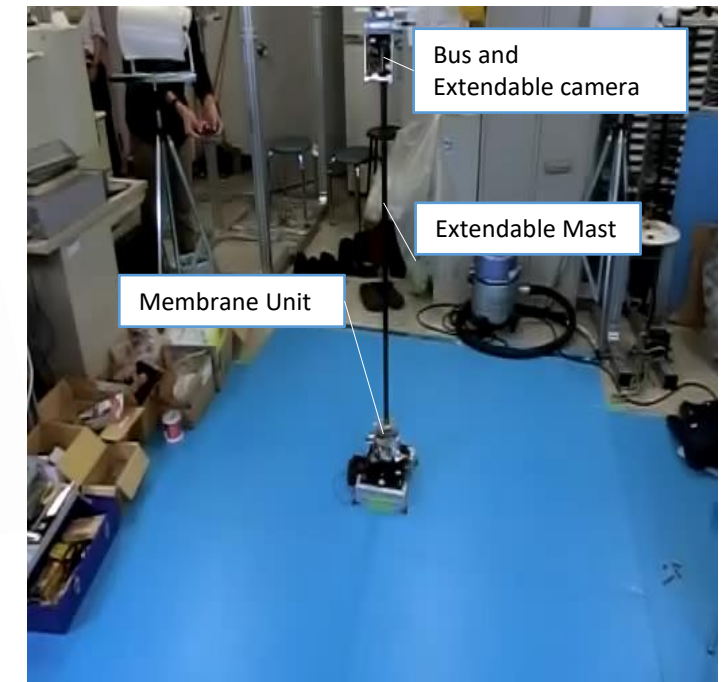
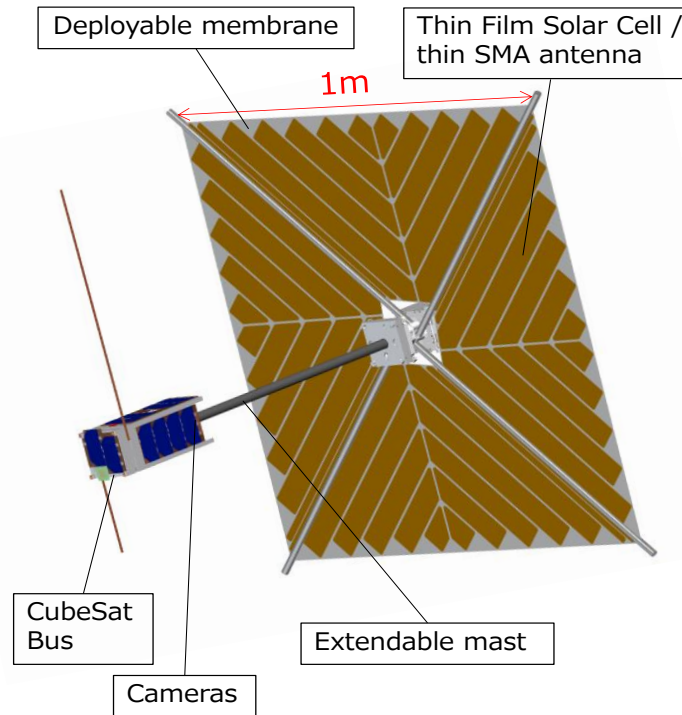
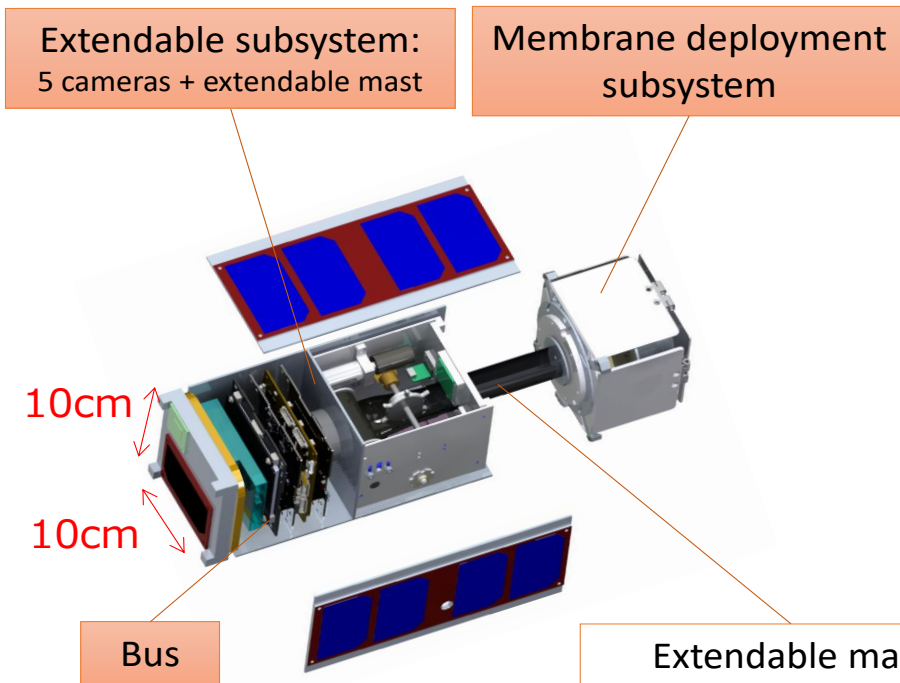

3U CubeSat Origami-Sat © Tokyo Institute of Technology

4. Types of Payload Systems & Examples of CubeSat mission

4.7 Technology demonstration: 3U CubeSat "Origami-Sat"

❖ Technology demonstration : multi-functional deployable membrane structure

- ❖ Deploy 1m x 1m membrane in space and obtain data about deployment dynamics and deployed shape.
- ❖ Measure the performance of thin-film devices on the membrane, such as thin-film solar cells and thin SMA (Shape-memory alloy) antennas.

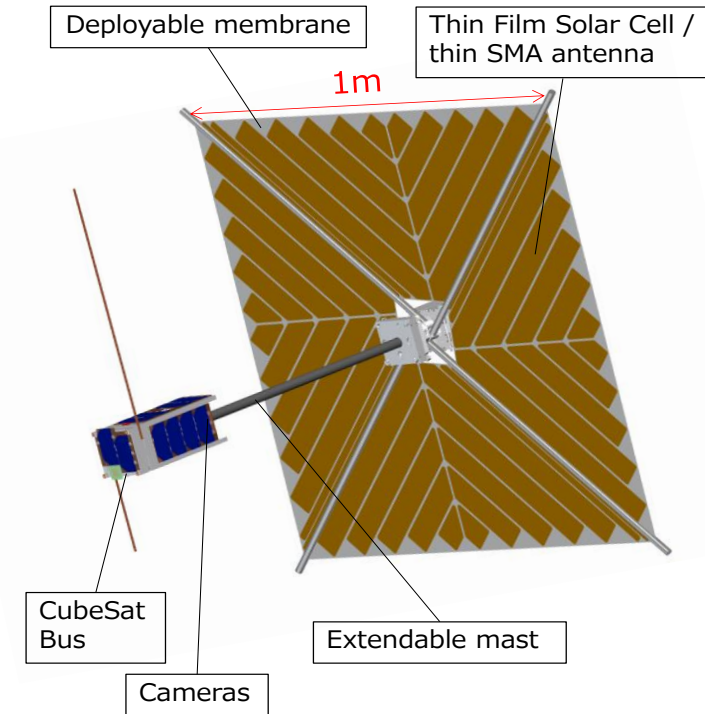
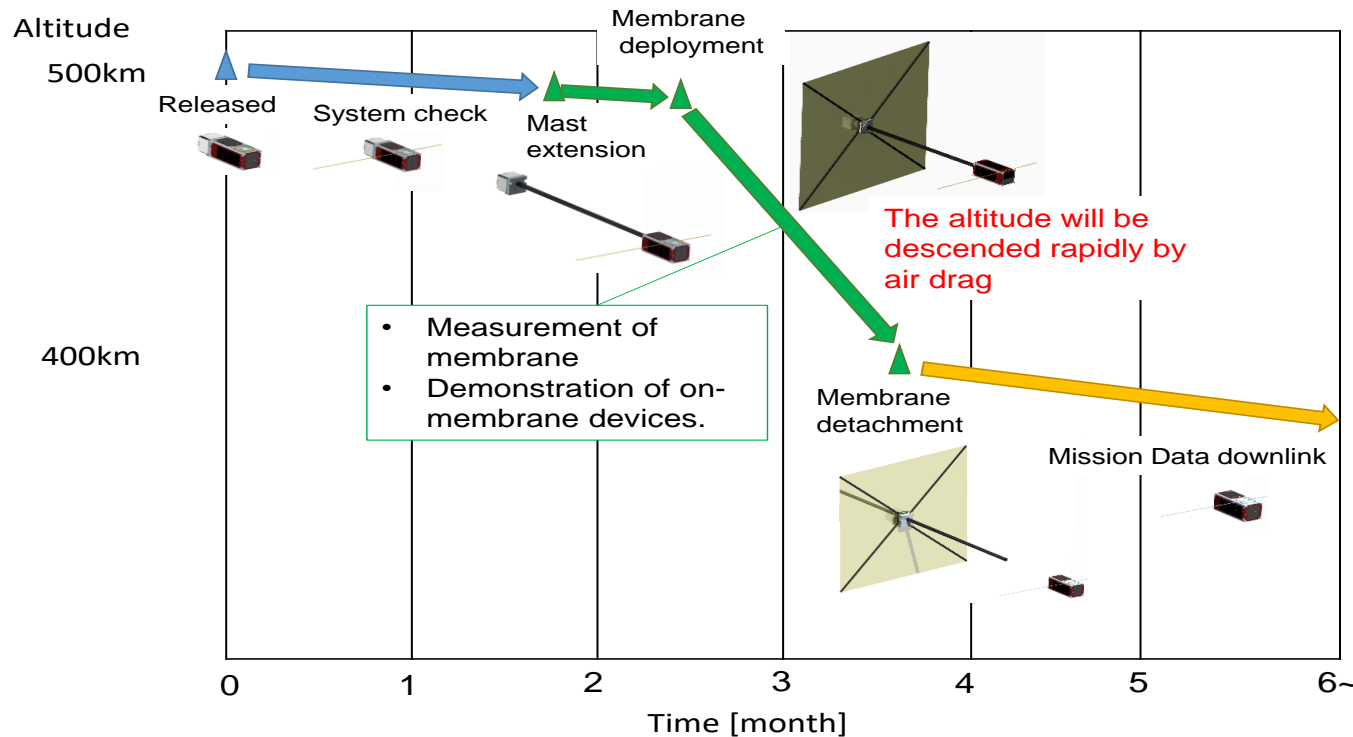

3U CubeSat Origami-Sat © Tokyo Institute of Technology

4. Types of Payload Systems & Examples of CubeSat mission

4.7 Technology demonstration: 3U CubeSat "ALE-EDT"

❏ Technology demonstration : Electro-dynamic tether

- ❏ Electro-dynamic tether for de-orbiting and re-entry into Earth atmosphere.
- ❏ 3-axis attitude control is used to control the satellite attitude during the extension of the electrodynamic tether. The device will be useful for space debris mitigation and prevention in higher altitude orbits, as it can operate independent of atmospheric drag.

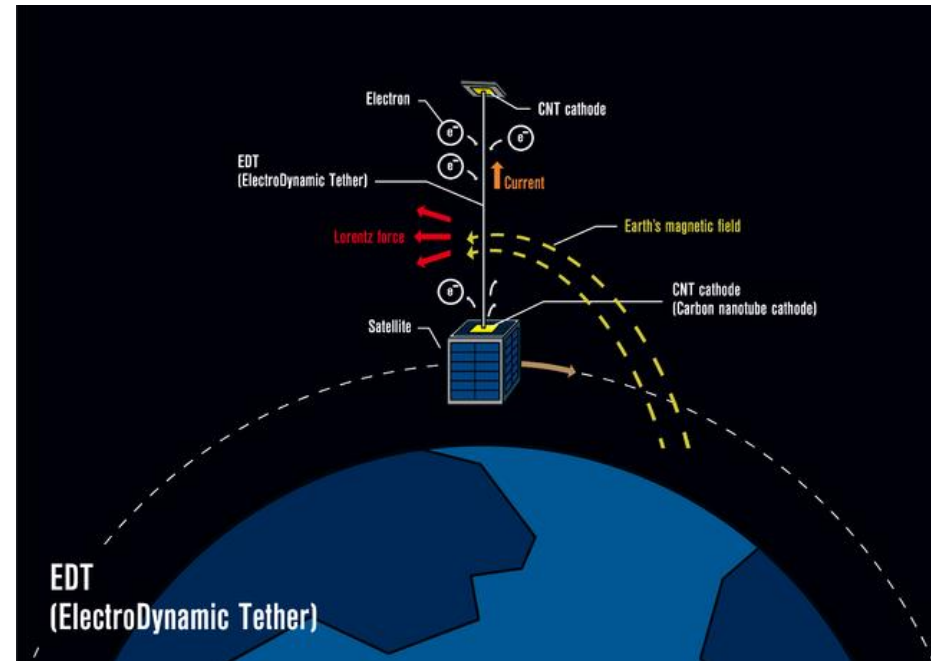
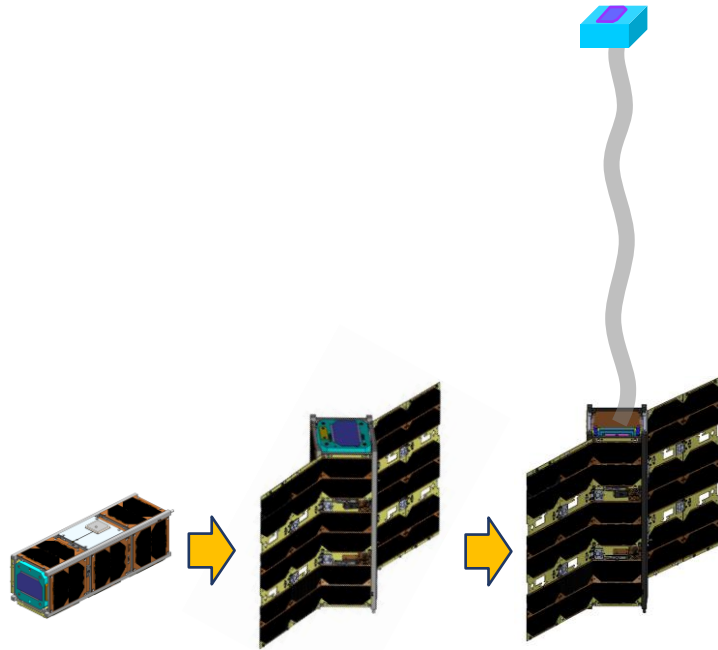

© ALE Co., Ltd.



5. Conclusion

5. Conclusion

5.1 Example of Requirements and Constraint related to payload

Examples of constraints related to orbit insertion of CubeSat and Payload

- ❏ CubeSat Standard : size, weight, and shape (Depends on the rocket and CubeSat deployer)
- ❏ Orbit Lifetime : Atmospheric drag can be a limiting factor for mission life in low earth orbit (LEO)
- ❏ Vibration, shock, and acceleration associated with orbit insertion

Example of system requirements for payload.

- ❏ Electrical Interface requirement
 - ❏ I2C, SPI, UART, 5V, 3.3V, etc.
- ❏ Attitude and Determination requirement
 - ❏ Determination accuracy and control accuracy, etc.
- ❏ Configuration, size, shape and mass requirement
- ❏ Orbital requirement
 - ❏ Sun-synchronous orbit, etc. Relates to increase/decrease in launch opportunities.
 - ❏ Electro Magnetic Compatibility (EMC) requirement, etc.

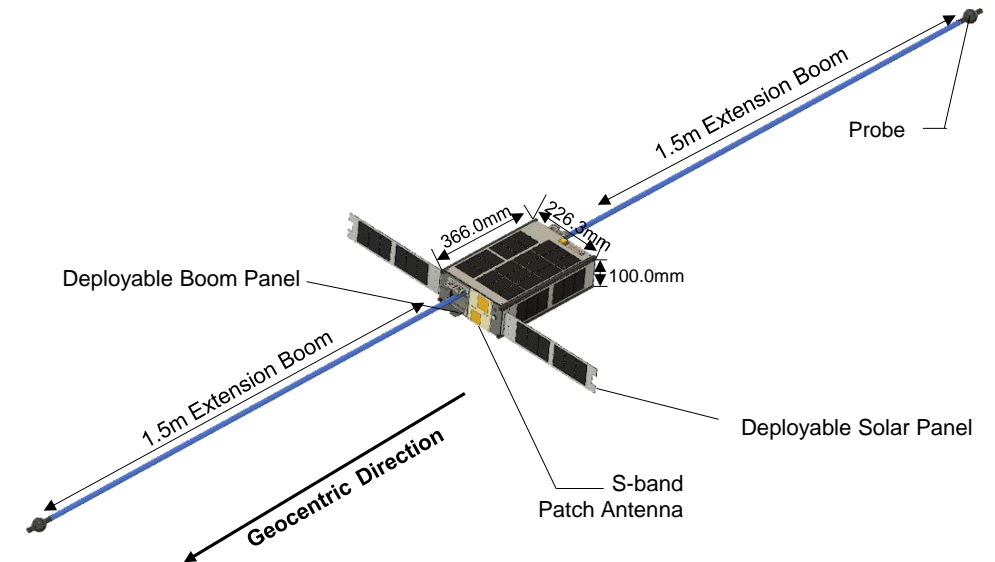

CubeSat systems have strong inter-device coupling. Aim for an optimal CubeSat by flexibly sharing limited resources (power, heat, communication, structure, data, etc.) while satisfying various requirements and constraints.

5. Conclusion

5.1 Requirements and Constraint : Integration and Test

❏ “Test like you fly”

- ❏ Test as many expected functions as possible before interfacing it with other systems.
- ❏ Environmental testing includes vibration testing, thermal vacuum testing, shock testing, EMI/EMC testing, and anything else required by the launch vehicle provider.
- ❏ Keep the scope small with testing and add components systematically, testing them along the way.
 - ❏ It is also useful to test individual subsystems before integrating all components. This allows for early detection of design problems and reduces excessive testing of the entire system.
- ❏ Never assume that a board or subsystem that works well in standalone testing will work well when integrated with other boards or subsystems.

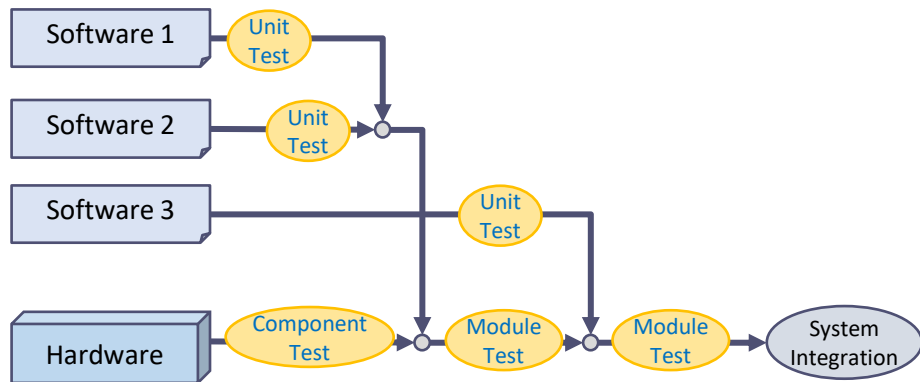

Electrical Testing

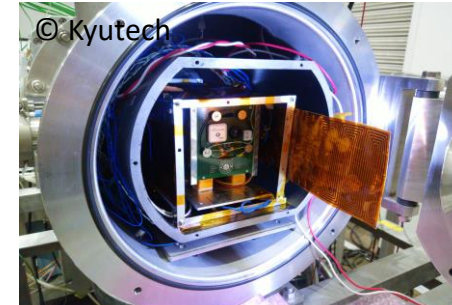

Thermal & Vacuum Testing

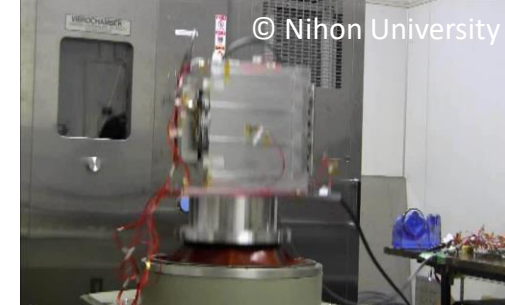

Vibration Testing

Pre- and post-test inspections, measurements, and functional demonstrations are important.

5. Conclusion

5.1 Requirements and Constraint : Integration and Test

- Tests and simulations ensure that everything works properly before putting it into orbit.
- Structural analysis, Attitude and Orbit analysis, Thermal analysis, Electricity analysis, etc.

Structural Analysis

Check whether the structural requirements for payloads are met.

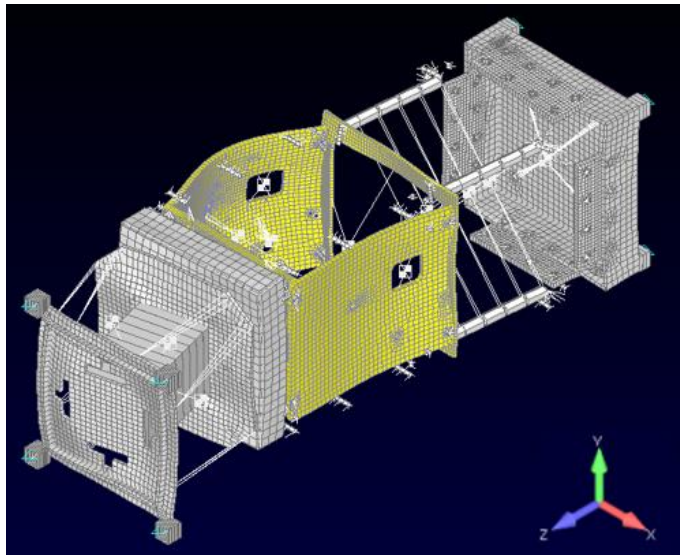

3U CubeSat Origami-Sat © Tokyo Institute of Technology

Attitude and Orbit Analysis

Check whether the attitude and orbit requirements for payload are met.

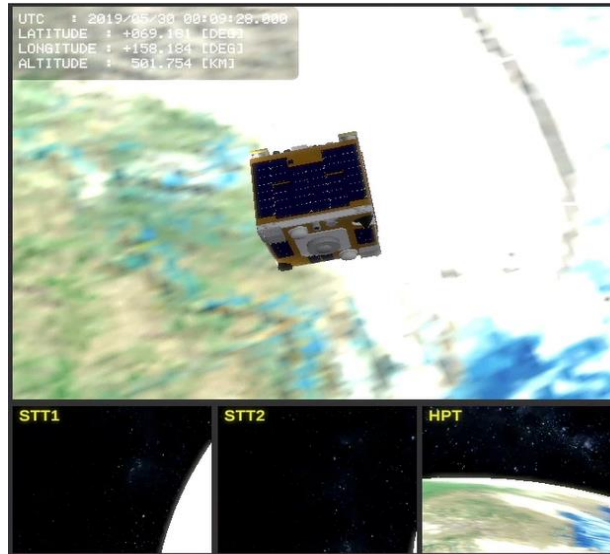

© Tohoku University

Thermal Analysis

Check whether the thermal requirements for payload are met.

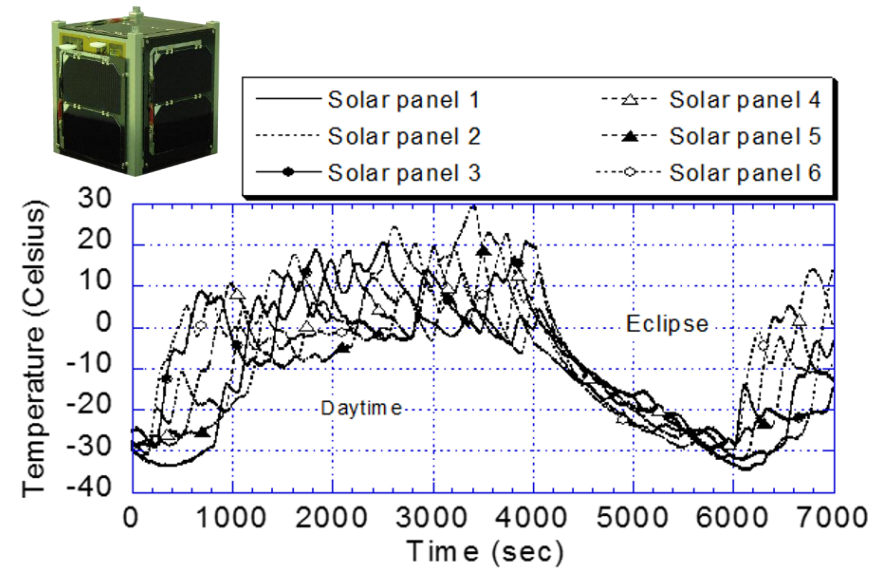

© Nihon University

Is the design fully capable of meeting all the requirements and constraints?



Thank you very much.

[Disclaimer]

The views and opinions expressed in this presentation are those of the authors and do not necessarily reflect those of the United Nations.