

“AZERBAIJAN POSITIONING OBSERVATION SYSTEM (AZPOS) FOR REAL ESTATE CADASTRE DATA BASE”



Chingiz Tanirverdiyev — Real estate cadastre department of Real Estate Cadastre and Technical Inventory Centre
e-mail : chtanriverdiyev@emdk.gov.az

REAL ESTATE REGISTRATION PROJECT

Component C: Base Mapping and Land Cadastre

Subcomponents:

C.1 Establishing 37 Continuously Operating Reference Stations /CORS;

C.2 Production of orthophotomaps through satellite and aerial imagery;

C. 3 Development of land parcel maps;

C. 4 Improving the sustainability of the services.

Component A2/B1 :

Development of Real Estate Registration, Cadastre and Management System.

AZPOS (CORS) Network Azerbaijan System Overview

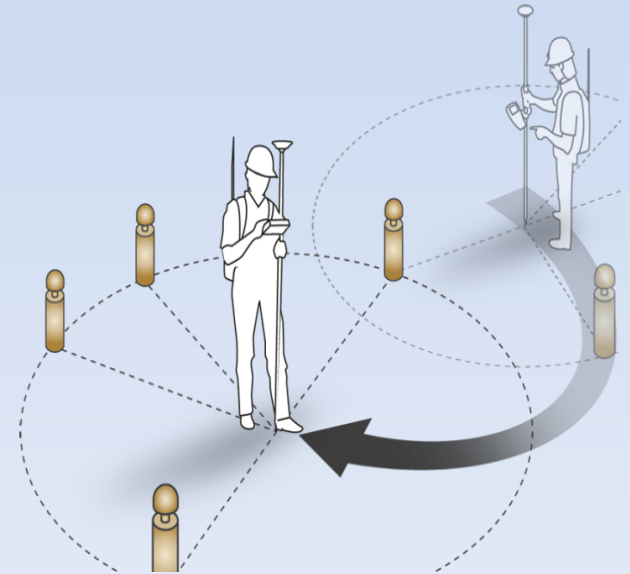
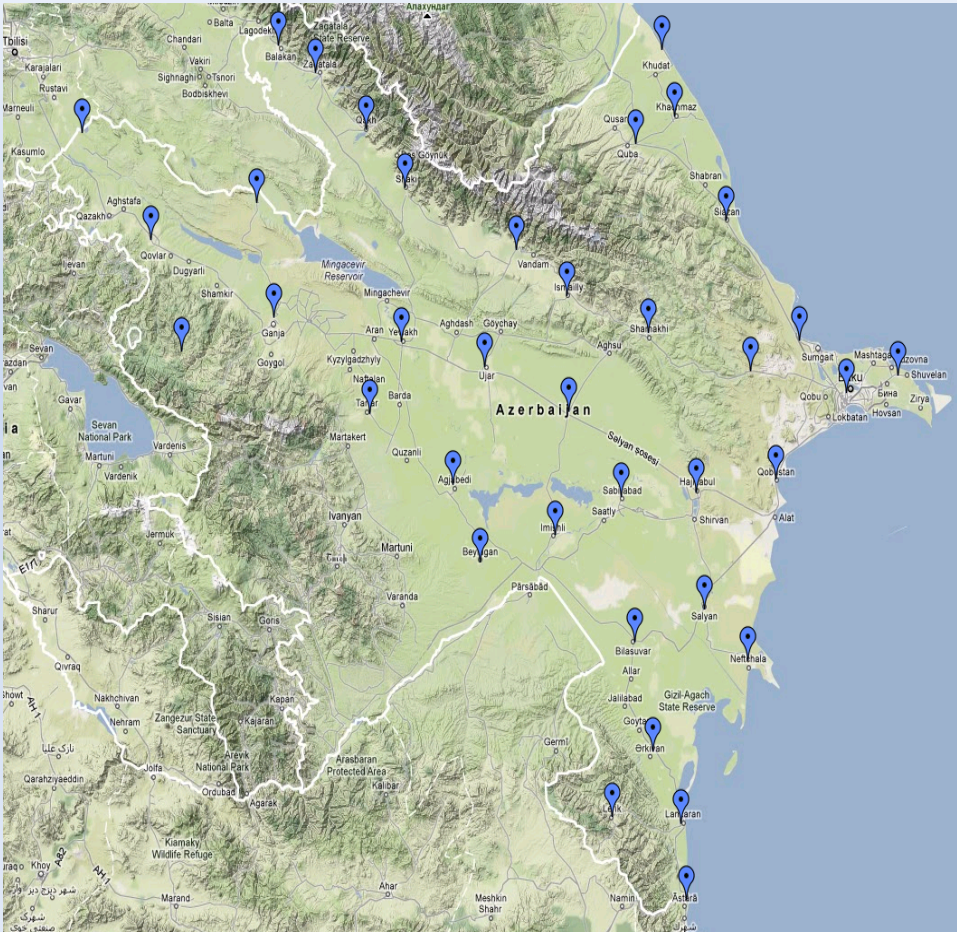

AZPOS (CORS) Network Azerbaijan System Overview

- Network design
- Good spacing
- Similar altitudes
- Good observation conditions

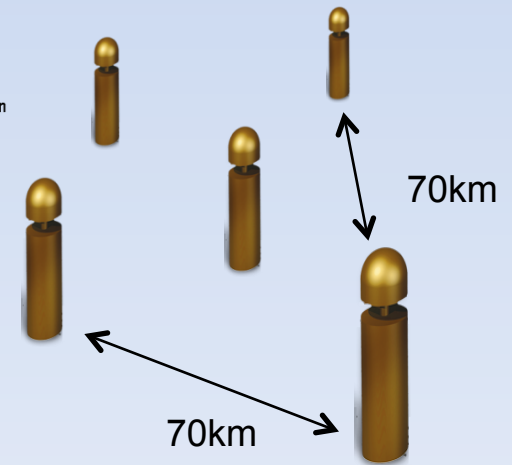
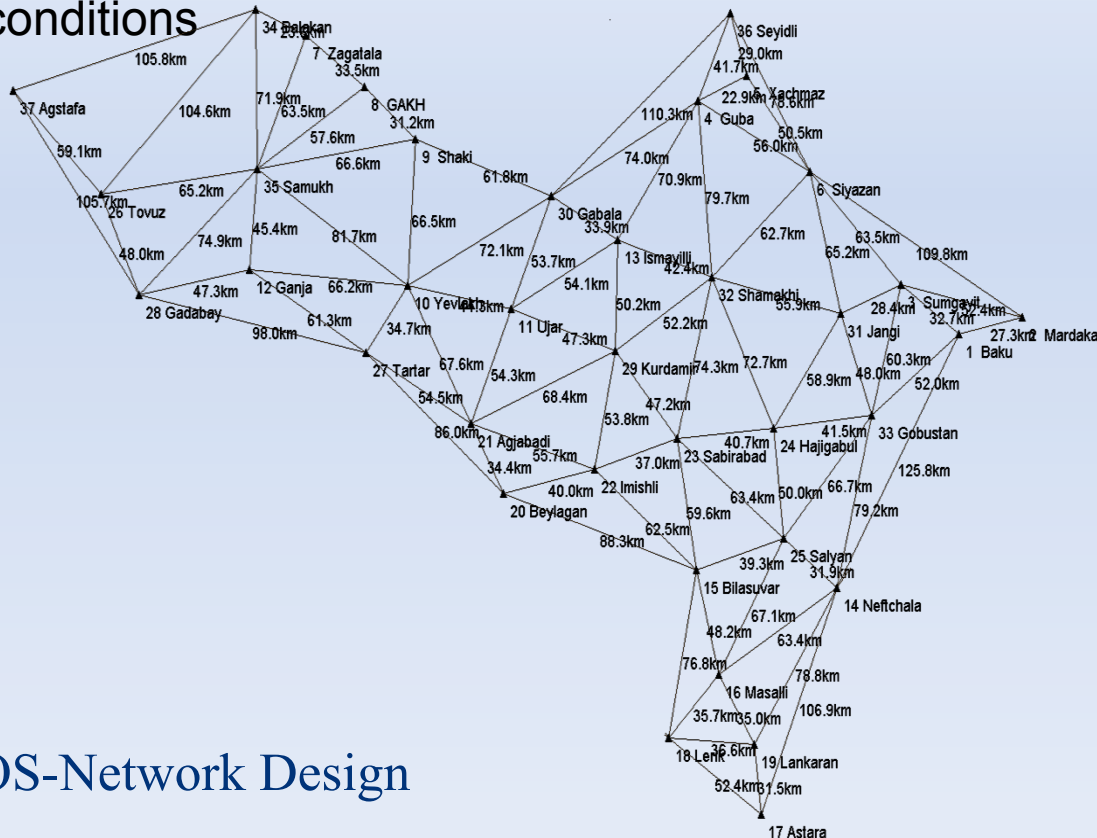
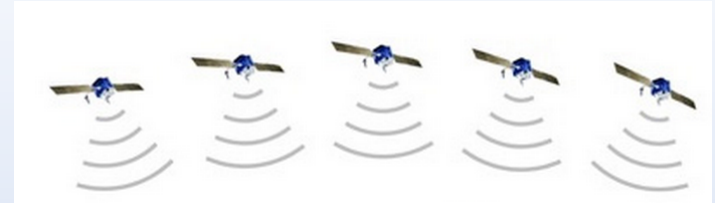

AZPOS-Network Design

AZPOS (CORS) Network Azerbaijan System Overview

AZPOS will provide the following benefits:

- Access to comprehensive geospatial reference systems;**
- High productivity and operation availability in common system;**
- Real-time 3D positioning, RTK in cm level and DGNSS in meter level operations;**

All surveying works in the Republic will be carried out in the same system and format. Map and cadastral works, engineer surveying, underground communication works, planning works etc. will be carried out rapidly and with reduced costs by means of the system.

AZPOS (CORS) Network Azerbaijan System Overview

AZPOS provide different GNSS Surveying Methods:

- Post-Processing;**
- RTK (Real Time Kinematics);**
- DGNSS (Differential Global Navigation Satellite System).**

The following aspects have been considered while construction of antenna ground points and installation of communication network for AZPOS development:

- providing the protection of antennas;**
- providing the sustainability of selected locations;**
- no limitations in internet access of antenna;**
- eliminating thunder risks;**
- non-existence of underground communications;**
- maintenance of construction works, installation of antenna;**
- WGS-84 coordination system has been considered reasonable in UTM38,39 projection**

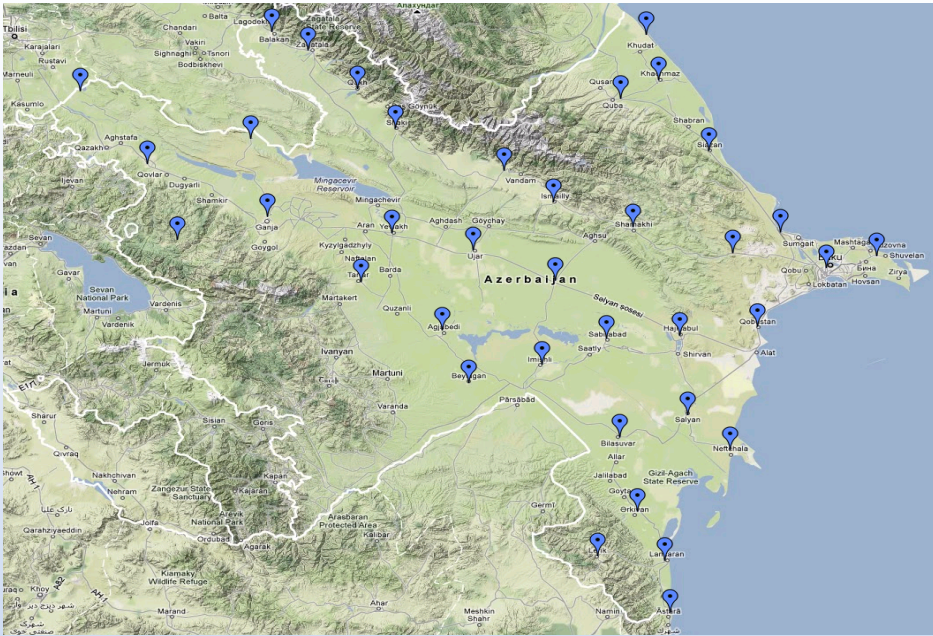

AZPOS (CORS) Network Azerbaijan System Overview

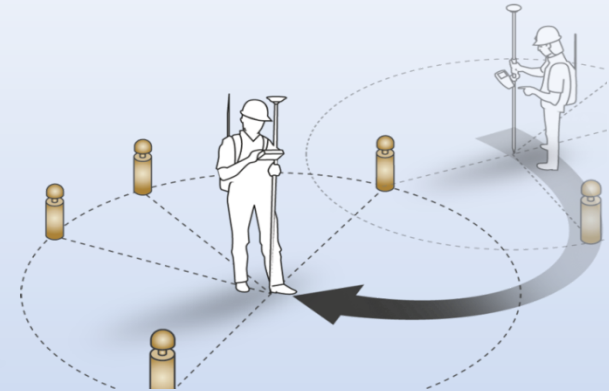

The Management Centre has been provided with software which controls the activities of the stations, as well as able to maintain data management, data corrected in real time adjustments and calculations.

The Control Centre is monitoring the data received from 37 reference stations in the Republic territory and provides 100 parallel users with RTK services, meantime 25 parallel users with Web services.

AZPOS (CORS) Network Azerbaijan System Overview

Support for Multiple Applications

- **National Mapping Producers**
- **Cadastral**
- **GIS**
 - **Utility Companies**
 - **Telecoms**
 - **Transport Departments**
(fleet management...)
- **Infrastructure & Road construction**
- **Natural Resource Management**
(Mining, Exploration)
- **Scientific (atmospheric modelling, seismic monitoring,...)**
- **Meteorological Agency,**
Weather forecasts
- **Environmental Agencies**
- **Agriculture**
- **Natural Hazards & Disaster Management**

AZPOS (CORS) Network Azerbaijan System Overview

What does CORS Network consist of?

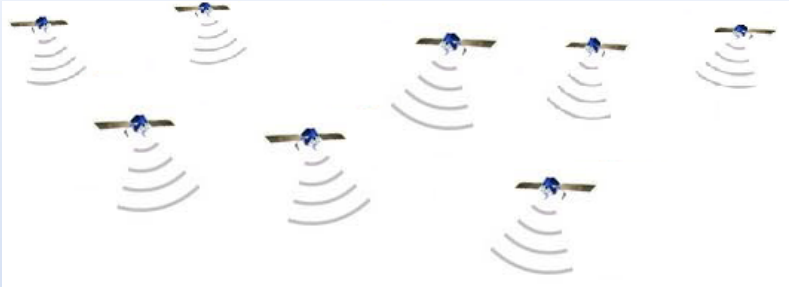

CORS Network AZPOS consists of four segments:

- **Spatial Segment:**
 - GPS, Glonass, Galileo, Compass
- **Ground Segment**
 - GNSS antennas and receivers
- **Control Center**
- **User**

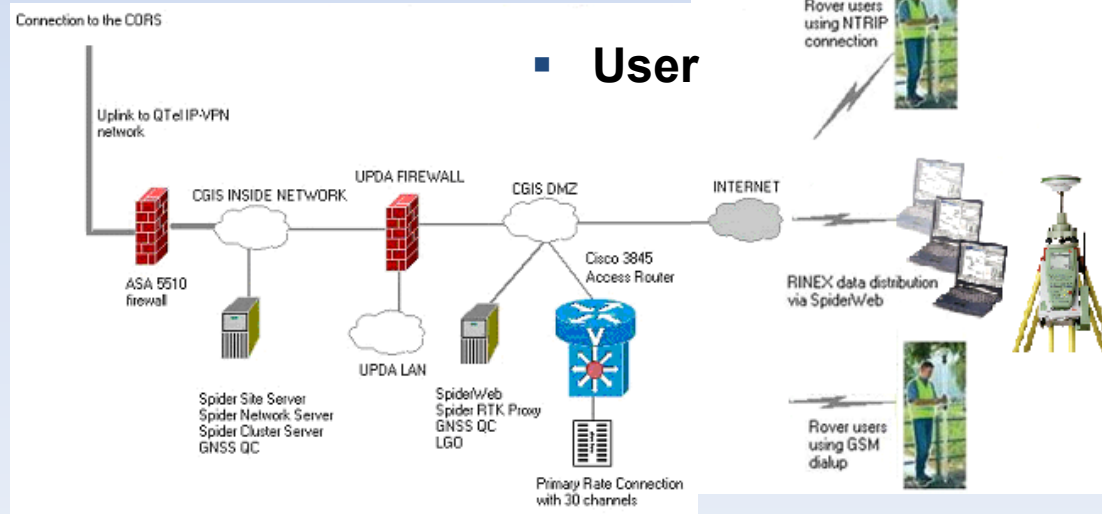

AZPOS (CORS) Network Azerbaijan System Overview

How does it work?

Setting up a CORS Mast

- **Antenna**
- **Cables**
- **Lightning protection**
- **Antenna mount**
- **Monumentation**
- **Underground**
- **Station environment**



AZPOS CORS Network AZPOS DATA CENTER

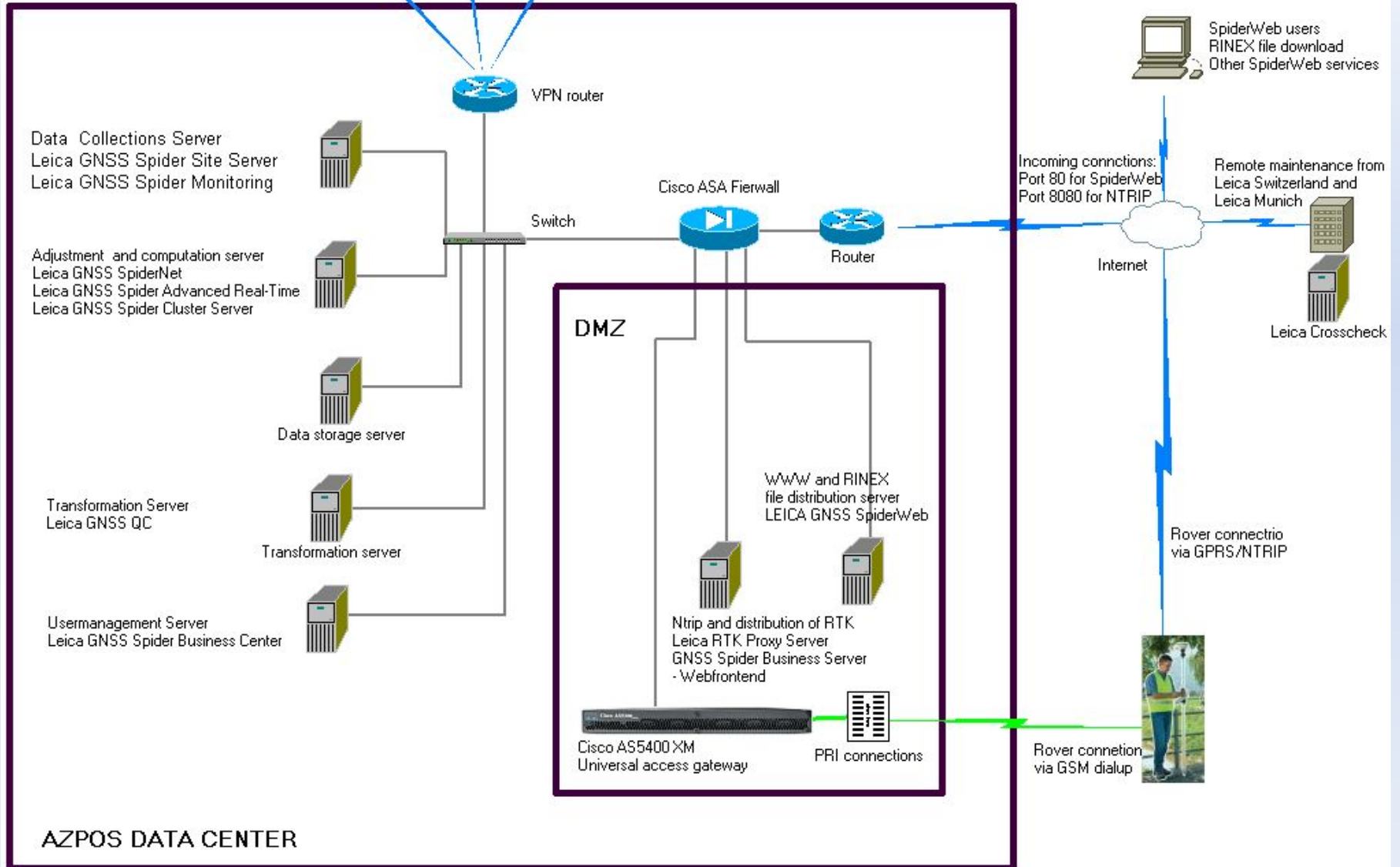

AZPOS Network Types of Services

- Post-processing

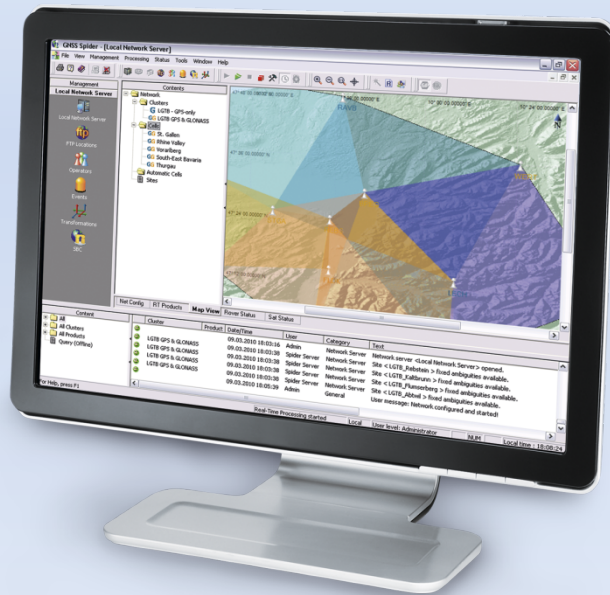

- Real-Time

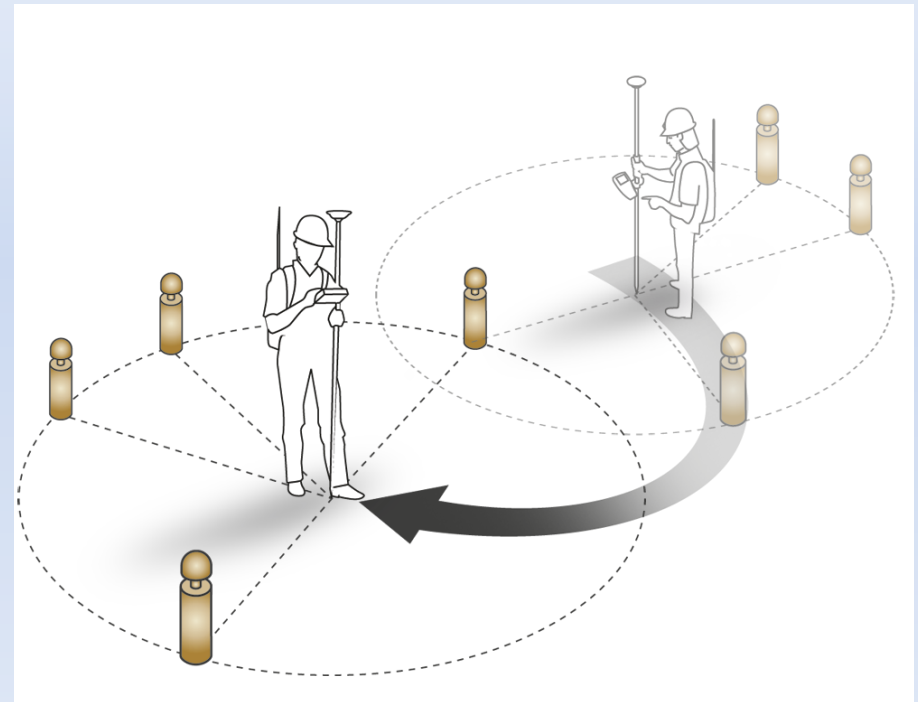

AZPOS Network

Post-processing Services

Online Coordinate Computation Service

- No RINEX download needed
- No office software needed

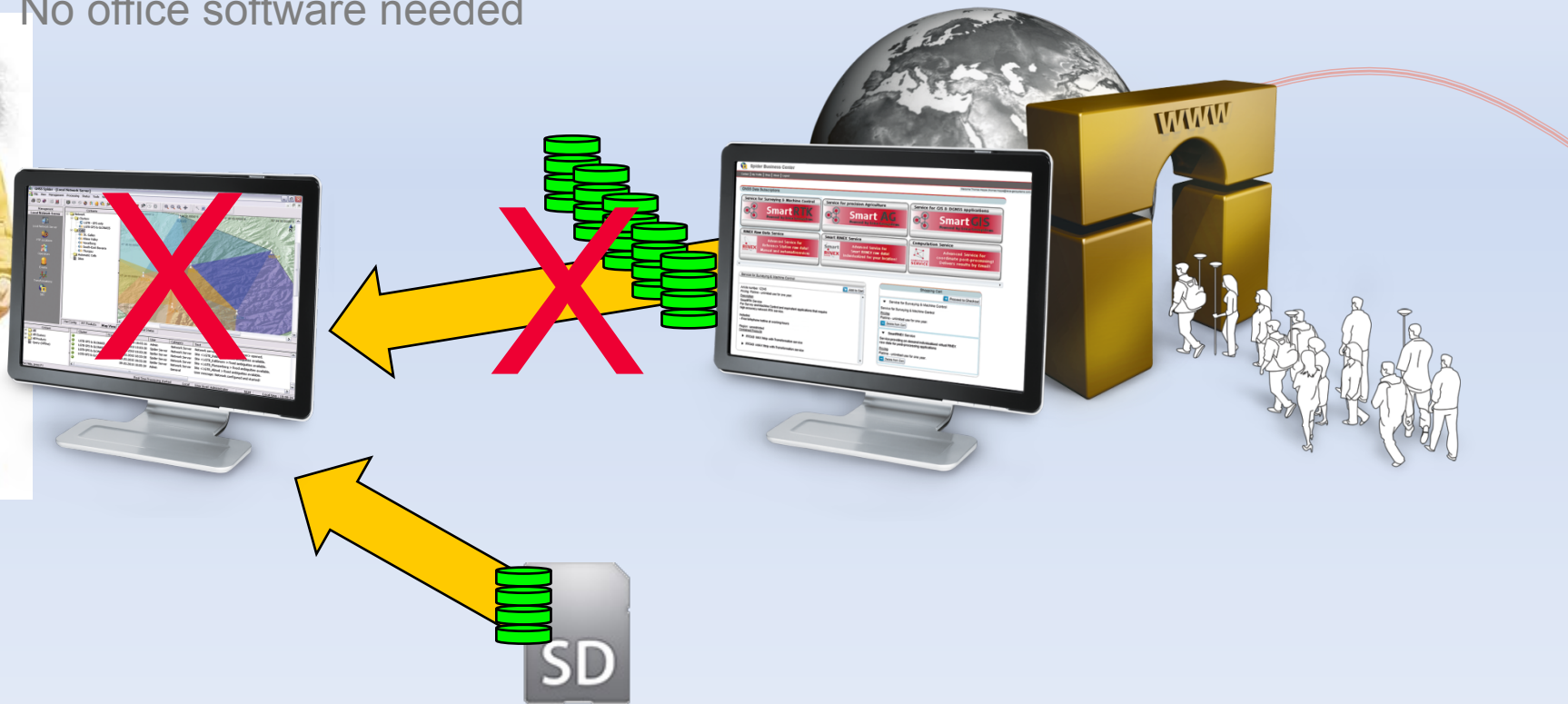

AZPOS Network

Post-processing Services

Online Coordinate Computation Service

- upload field data to webportal
- online computation made by SpiderWeb

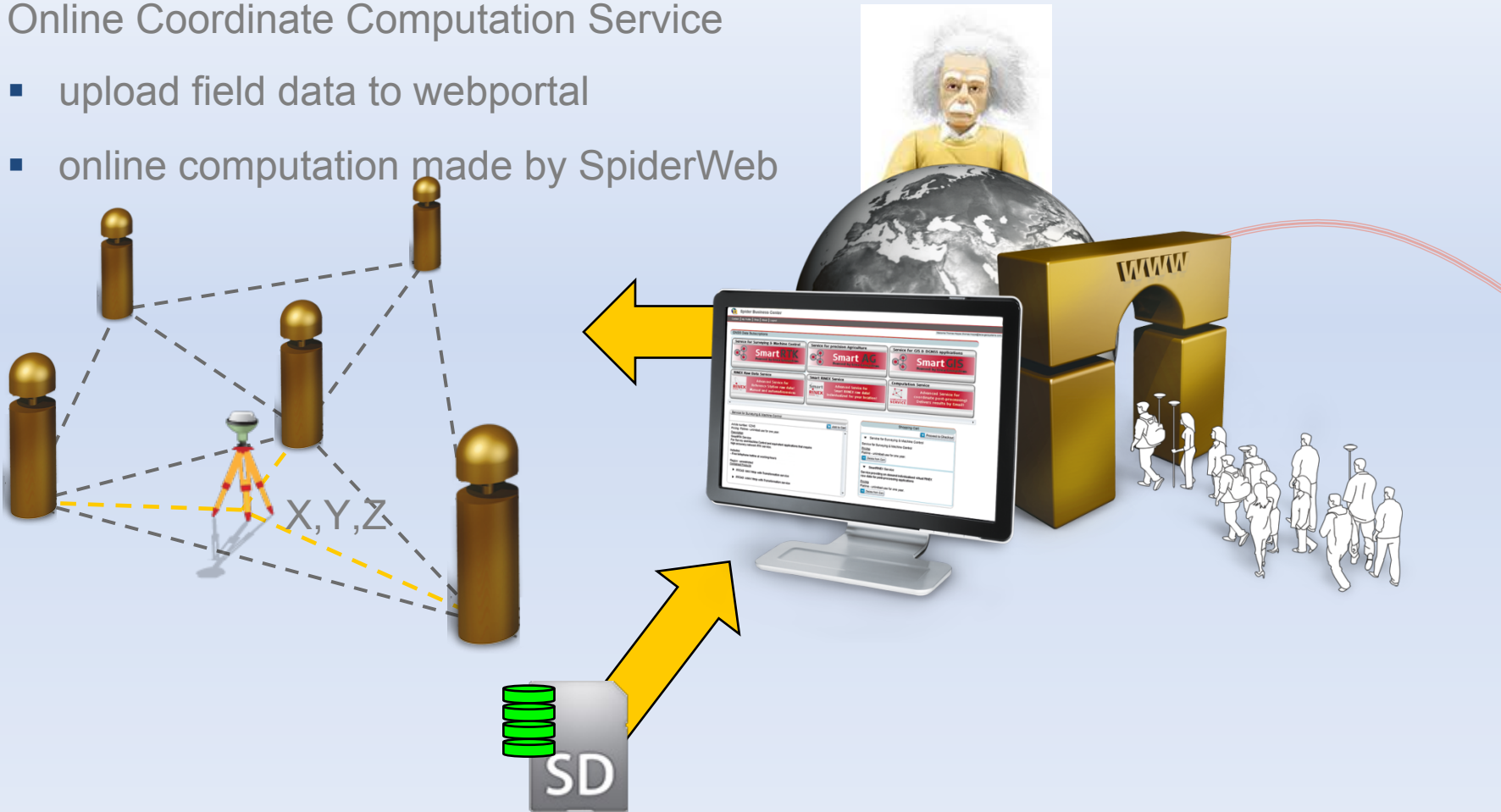

AZPOS Network

Real-Time Services



Single base RTK – Classical Approach Problems

- base becomes unlevelled
- loose power on radio or receiver
- base gets stolen

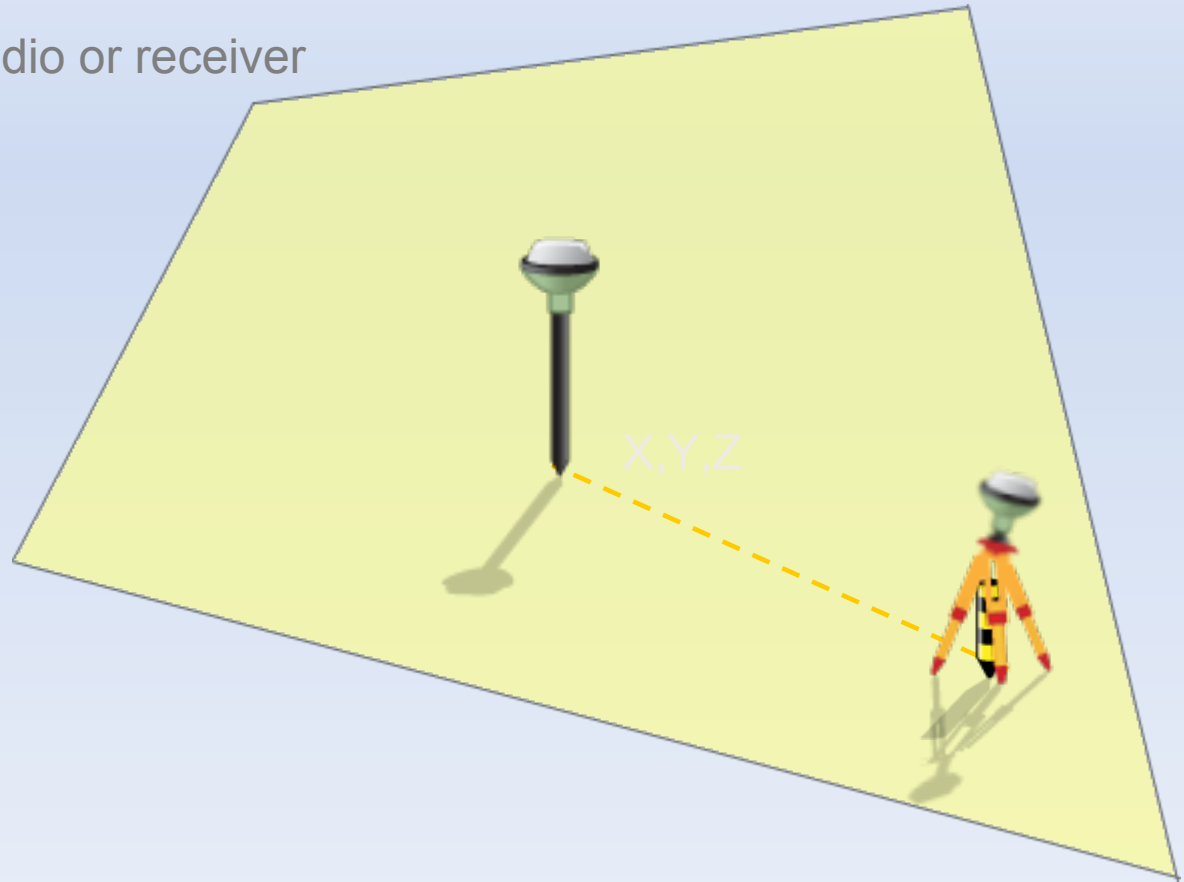

AZPOS Network Real-Time Services

CORS Single base RTK

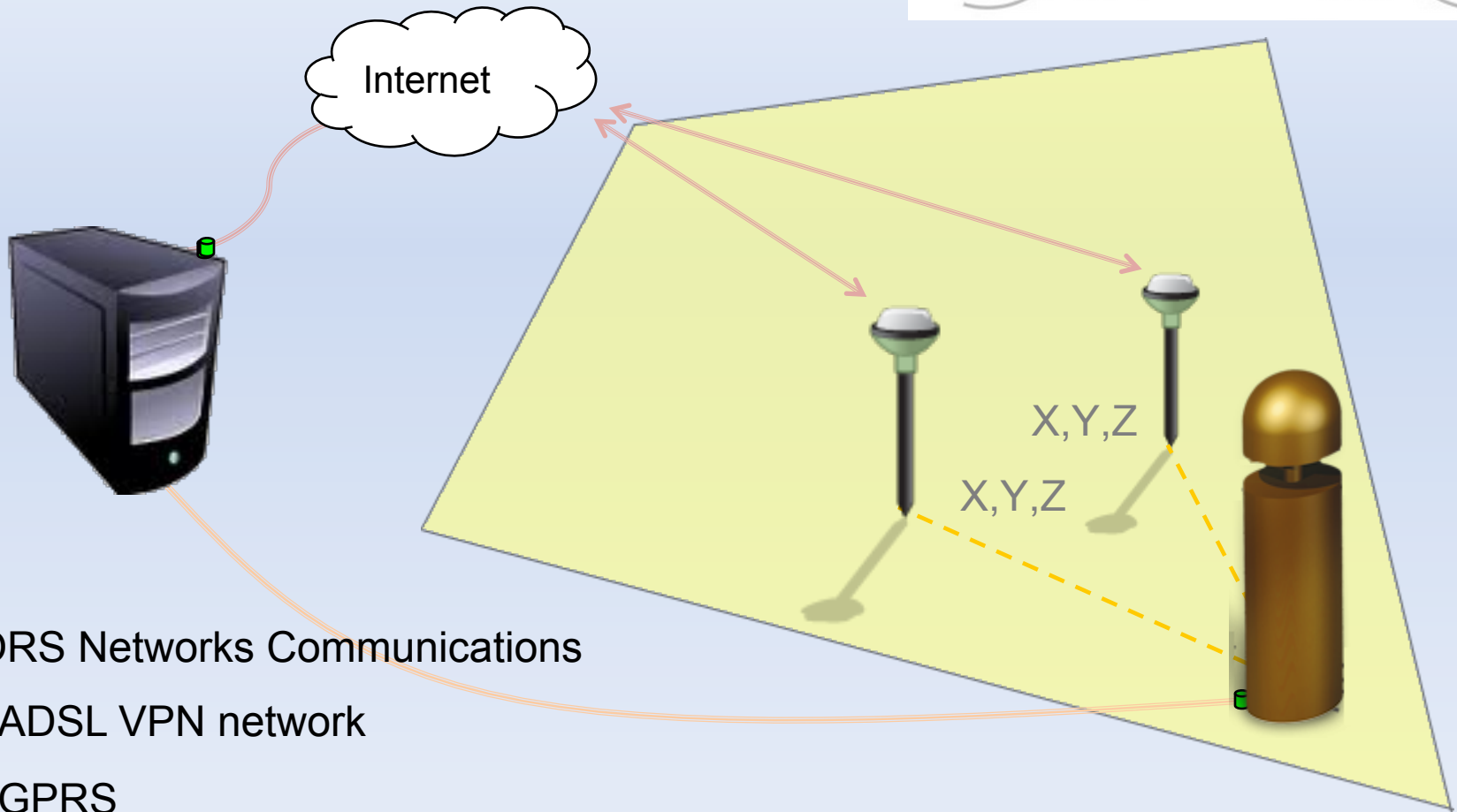

CORS Networks Communications

- ADSL VPN network
- GPRS

AZPOS Network Real-Time Services

Benefits

- ✓ Savings in
 - ✓ Hardware
 - ✓ Time
 - ✓ Man power
- ✓ Positioning Quality
 - ✓ Reliable
 - ✓ Consistent
 - ✓ Accurate

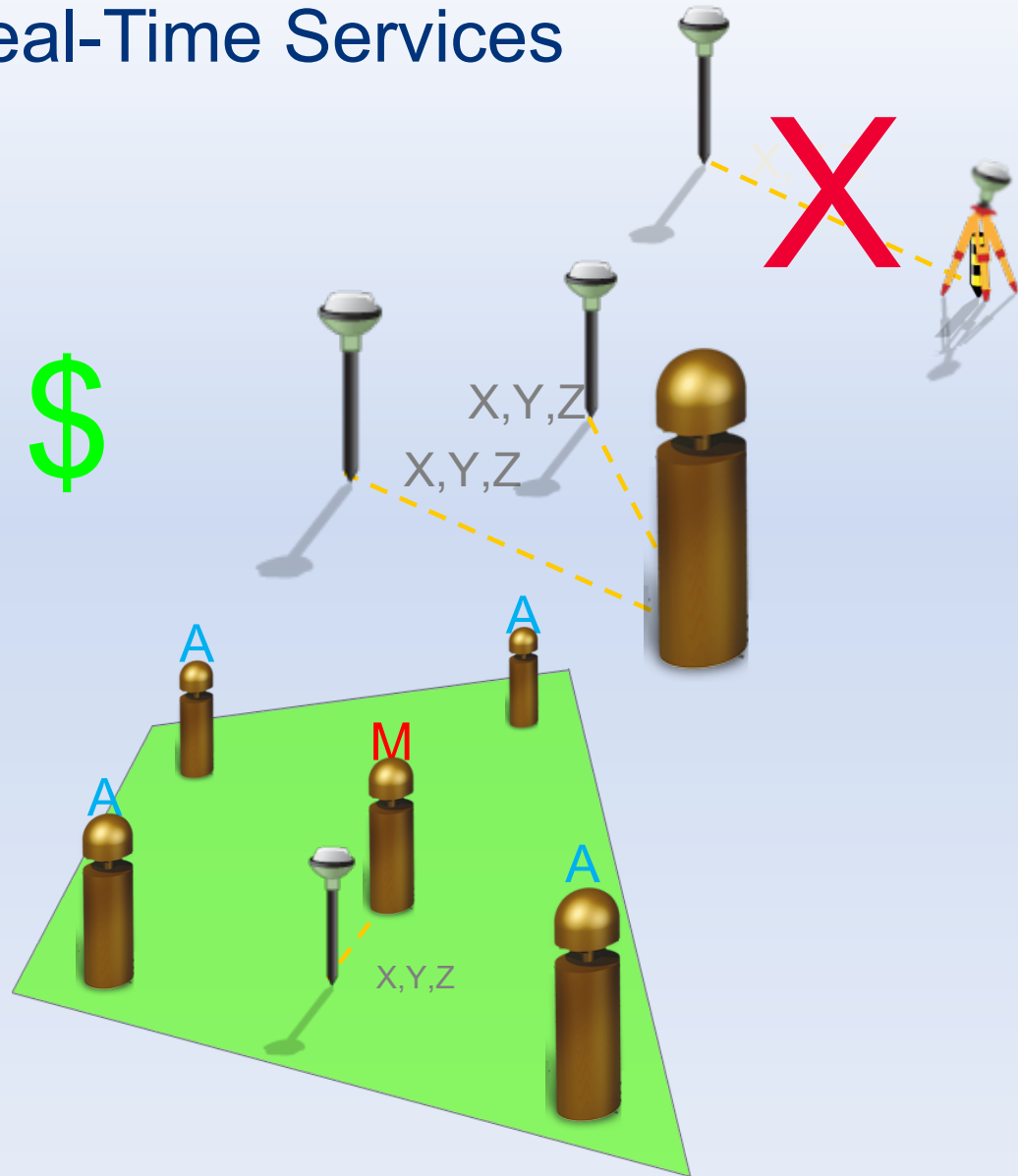

AZPOS Network Benefits

B E N E F I T S

- Increased coverage
- Improved availability
- Improved reliability
- Faster rover initialisations
- Consistent high accuracy
- Higher productivity
- No local base station required
- Fewer reference stations needed
- Working on a common datum



LAND STRUCTURE IN THE REPUBLIC OF AZERBAIJAN

There are 3 types of properties in the Republic of Azerbaijan : State, Municipal, Private.

- 57 % of land belongs to the state.
- 23% of land belongs to the municipalities.
- 20% of land belongs to the private ownership.

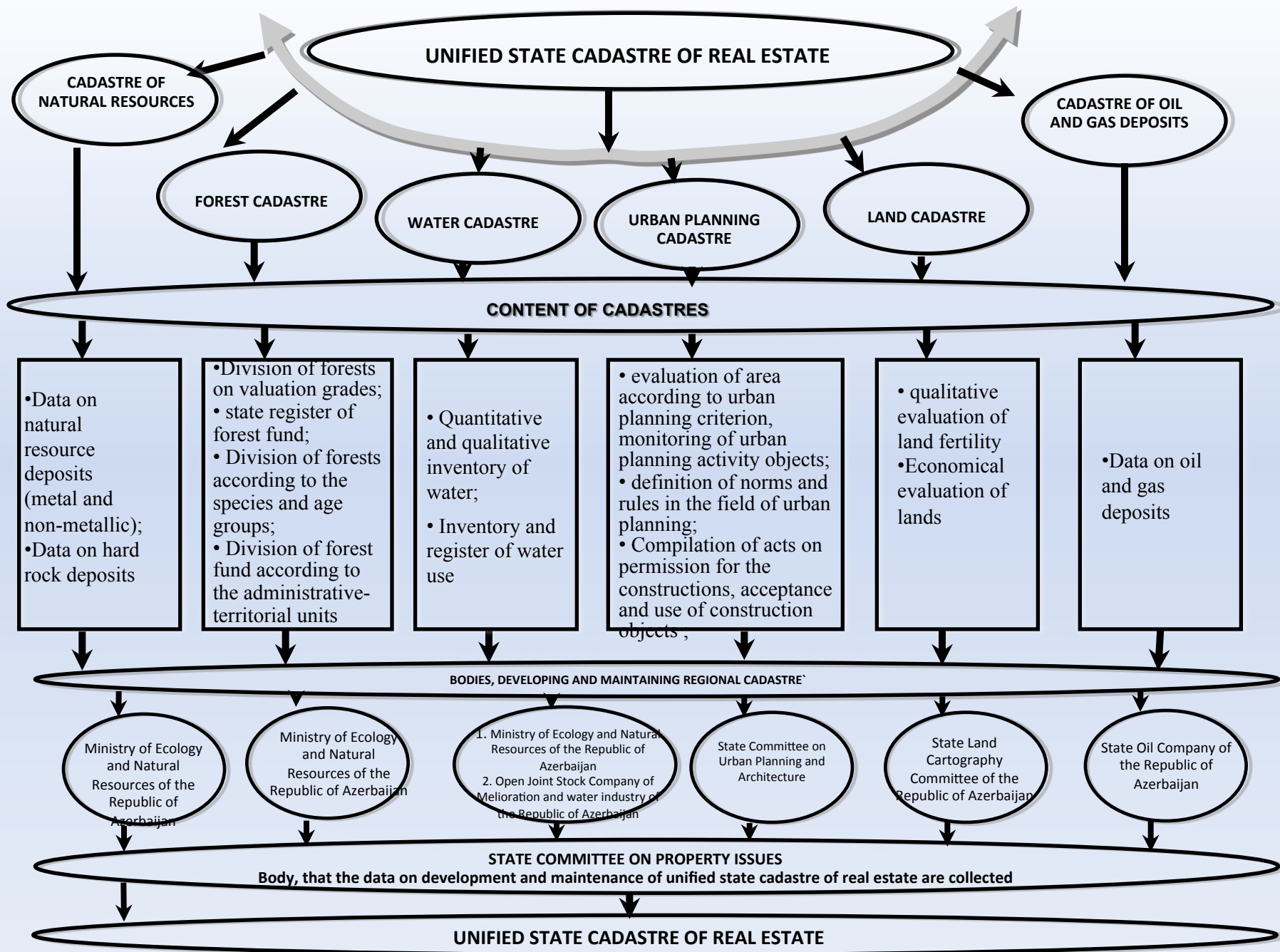

UNIFIED STATE CADASTRE OF REAL ESTATE

Unified state cadastre of real estate is implemented by Real Estate Cadastre and Technical Inventory Center (RECTIC) of SCPI.

ACTIVITY DIRECTIONS

- Development of digital cadastre database on all types of real estates not depending on its property type and assignment;
- Development of digital cadastre maps;
- Implementation of mass inventory of real estate;
- Preparing of zone-value maps for the purposes of mass evaluation of real estate;
- Cadastre evaluation of real estate;
- Cadastre services for citizens and business organizations, preparing cadastre plans and giving information.

NOTE: Address register system is implemented by RECTIC of SCPI.

CADASTRAL DATA COLLECTION MECHANISM

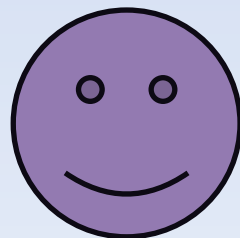
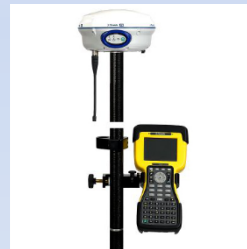
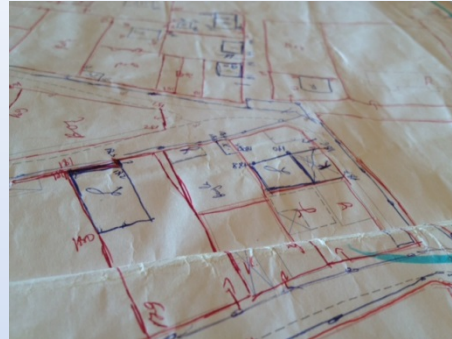

Activities and Aims for the Cadastre Project

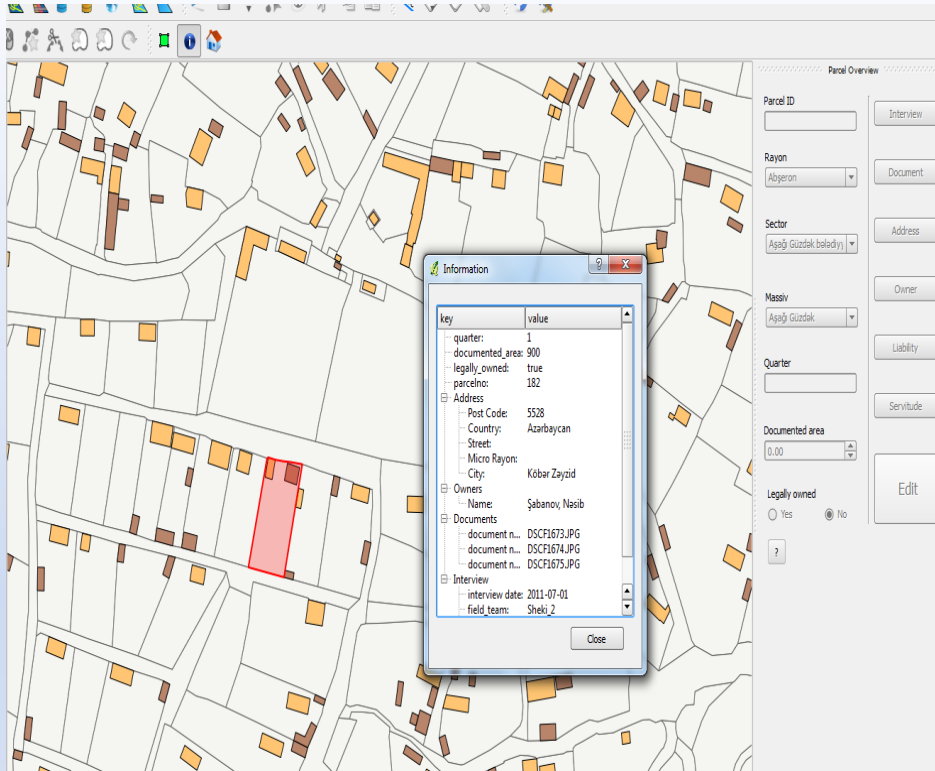

- **Capturing of ownership and boundary-data „on-site“**
- **Complete area systematic surveying**
- **Simplification of registration process**
- **Data base for legal registration of ownership and for municipal and state land management**



Activities and Aims for the Cadastre Project (cont.)

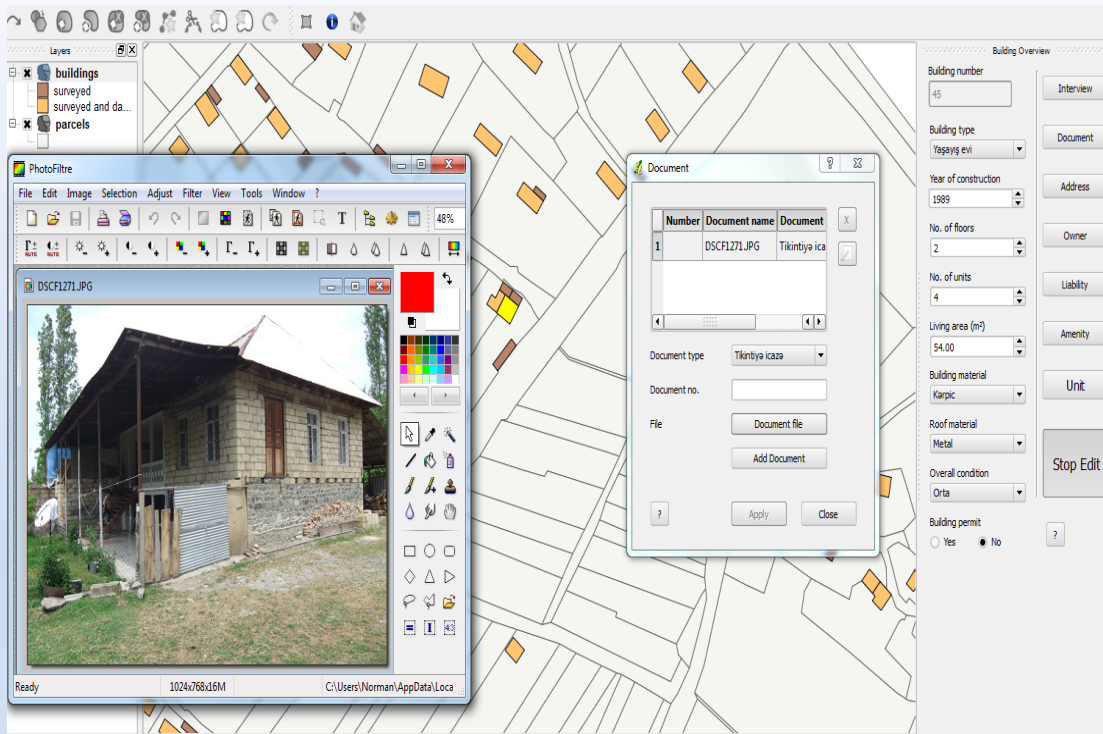

- Involvement of property owners in pilot areas
- Public awareness and information campaign
- Baseline survey with ex-ante and ex-post interviews
- Public presentation of surveying results
- Employment of local professionals for surveying and baseline survey

DESCRIPTION OF REAL ESTATES IN CADASTRE DATABASE AND DIGITAL MAP (FRAGMENT)

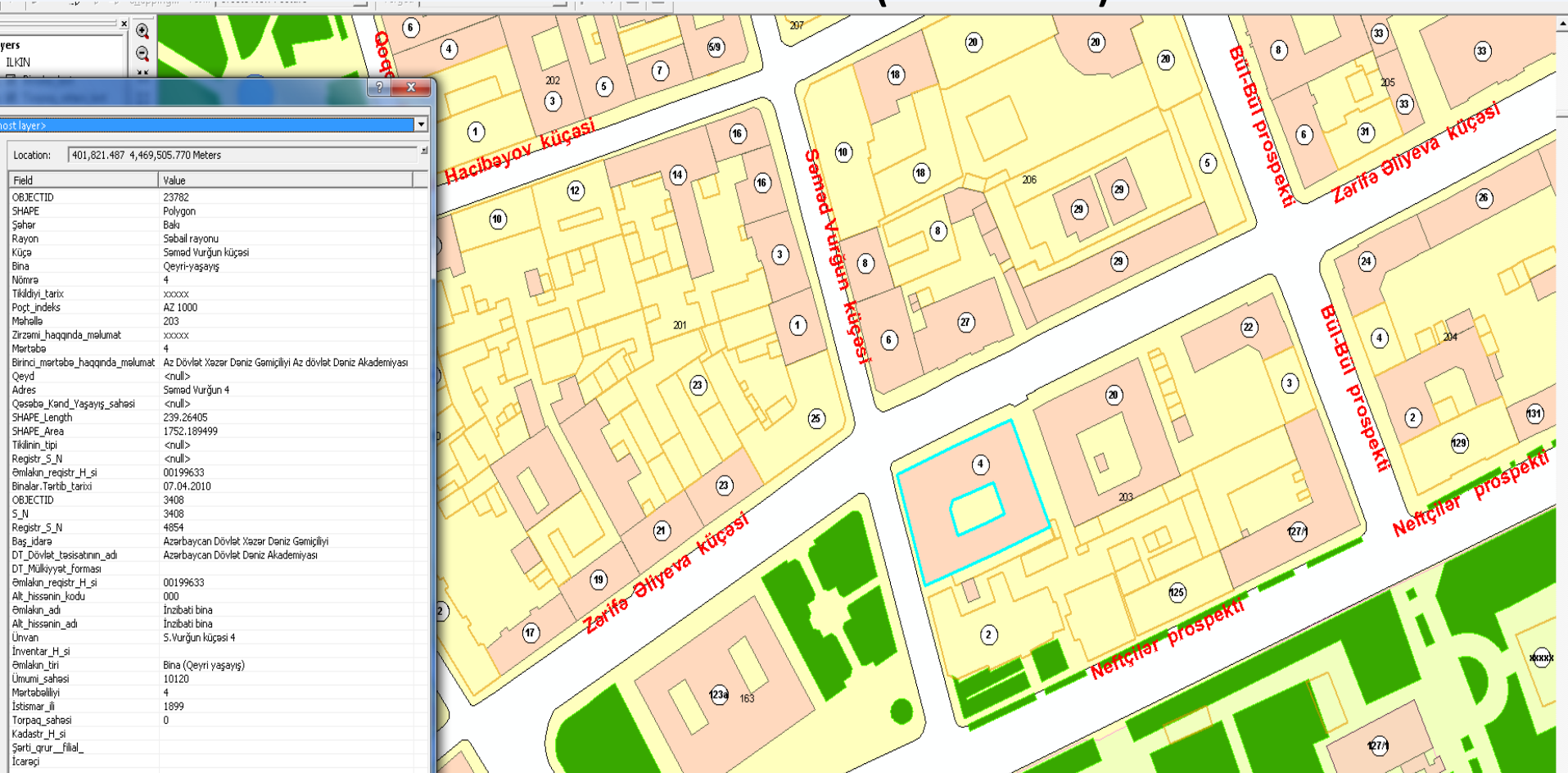

Küçə	Bina	Nömrə	Tikildiyi	Poçt ind	Məhəll	Zirzəmi	Mərt	Birinci mərtəbə haqqında	Qeyd	Adres	Qəsəbə Kən	SHAPE L	SHAPE A	Tikilinin tipi	Reqi	Əmlakın re	T
Nəfçilər prospekti/Bül-Bül pros	Yaşayış	127/1	<Null>	AZ 1000	203	<Null>	4	<Null>	<Null>	Nəfçilər 127/Bül-Bül 1	<Null>	192,5249	1153,617	Yaşayış evi	<Null>	00032118	0
Zərifə Əliyeva küçəsi	Qeyri-yaşayış	<Null>	<Null>	AZ 1000	203	<Null>	2	<Null>	<Null>	<Null>	<Null>	26,07590	41,95141	Su nasosxana	<Null>	00045079	0
Zərifə Əliyeva küçəsi	Qeyri-yaşayış	<Null>	<Null>	AZ 1000	203	<Null>	1	<Null>	<Null>	Zərifə Əliyeva 22	<Null>	19,84086	24,15186	Qaraj	<Null>	<Null>	0
Zərifə Əliyeva küçəsi	Qeyri-yaşayış	<Null>	<Null>	AZ 1000	203	<Null>	1	<Null>	<Null>	Zərifə Əliyeva 22	<Null>	20,80802	26,82468	Qaraj	<Null>	<Null>	0
Zərifə Əliyeva küçəsi	Qeyri-yaşayış	<Null>	<Null>	AZ 1000	203	<Null>	1	<Null>	<Null>	Zərifə Əliyeva 22	<Null>	20,66386	26,38172	Qaraj	<Null>	<Null>	0
Zərifə Əliyeva küçəsi	Qeyri-yaşayış	<Null>	<Null>	AZ 1000	203	<Null>	1	<Null>	<Null>	Zərifə Əliyeva 22	<Null>	19,97549	24,38856	Qaraj	<Null>	<Null>	0
Zərifə Əliyeva küçəsi	Yaşayış	20	xxxxxx	Az 1000	203	xxxxxx	4	Qeyri yaşayış sahəsi,"Daniel	<Null>	Zərifə Əliyeva 20	<Null>	256,1308	1483,819	Yaşayış evi	<Null>	00007544	0
Səməd Vurğun küçəsi	Qeyri-yaşayış	4	xxxxxx	AZ 1000	203	xxxxxx	4	Az Dövlət Xəzər Dəniz Gəmiçili	<Null>	Səməd Vurğun 4	<Null>	239,2640	1752,189	<Null>	<Null>	00199633	0
Səməd Vurğun küç	Qeyri-yaşayış	2	xxxxxx	AZ 1000	203	xxxxxx	3	Azərsun binası,Herbi komis	<Null>	Səməd Vurğun 2	<Null>	171,5651	1046,021	Herbi komissarlı	<Null>	<Null>	0
<Null>	Qeyri-yaşayış	<Null>	<Null>	AZ 1000	203	<Null>	1	<Null>	<Null>	<Null>	<Null>	17,71924	14,82239	Qazanxana	<Null>	<Null>	<
Səməd Vurğun küç	Qeyri-yaşayış	<Null>	<Null>	AZ 1000	203	<Null>	3	<Null>	<Null>	<Null>	<Null>	49,20479	126,0887	Herbi komissarlıq	<Null>	<Null>	0
Səməd Vurğun küçəsi	Qeyri-yaşayış	<Null>	<Null>	AZ1000	202	<Null>	1	<Null>	<Null>	Səməd Vurğun 9	<Null>	25,30799	38,86772	Qaraj	<Null>	<Null>	0

Conclusions and recommendations

- **At the moment AzPos is used to conduct geodetic surveying, cadastral works and GIS applications;**
- **AzPos provide real time horizontal coordinate determination with accuracy 2 cm in horizontal and 4 cm in vertical position. Baltic sea height determination with accuracy 5-10 cm is possible using EGM2008 geoids model;**
- **To increase accuracy up to 2 cm regional cooperation is necessary to integrate GNSS data of neighbouring countries and to develop quasigeoid model at the national level ;**
- **In the future AzPos could be used for scientific applications special for geodynamic investigations taking in account the risk of earthquakes.**

Real Estate Cadastre and Technical Inventory Centre:

address: Baku city, Yasamal region, 31 H. Javid avenue

email: www.emdk.gov.az

telephone: +994 12 5108430

THANK YOU FOR YOUR ATTENTION!