



The need for training integrating knowledge from the Sun to the Earth

80% of the data is not analyzed



The Abdus Salam
International Centre
for Theoretical Physics



IHY /10 years later

UNIVERSAL PHYSICAL PROCESS : DYNAMO

SYSTEMIC APPROACH

Example of Solar Flare

HISTORY

From IGY the CEJ

NEW TRAINING

THE PERENNIALTY IS ASSURED

1983

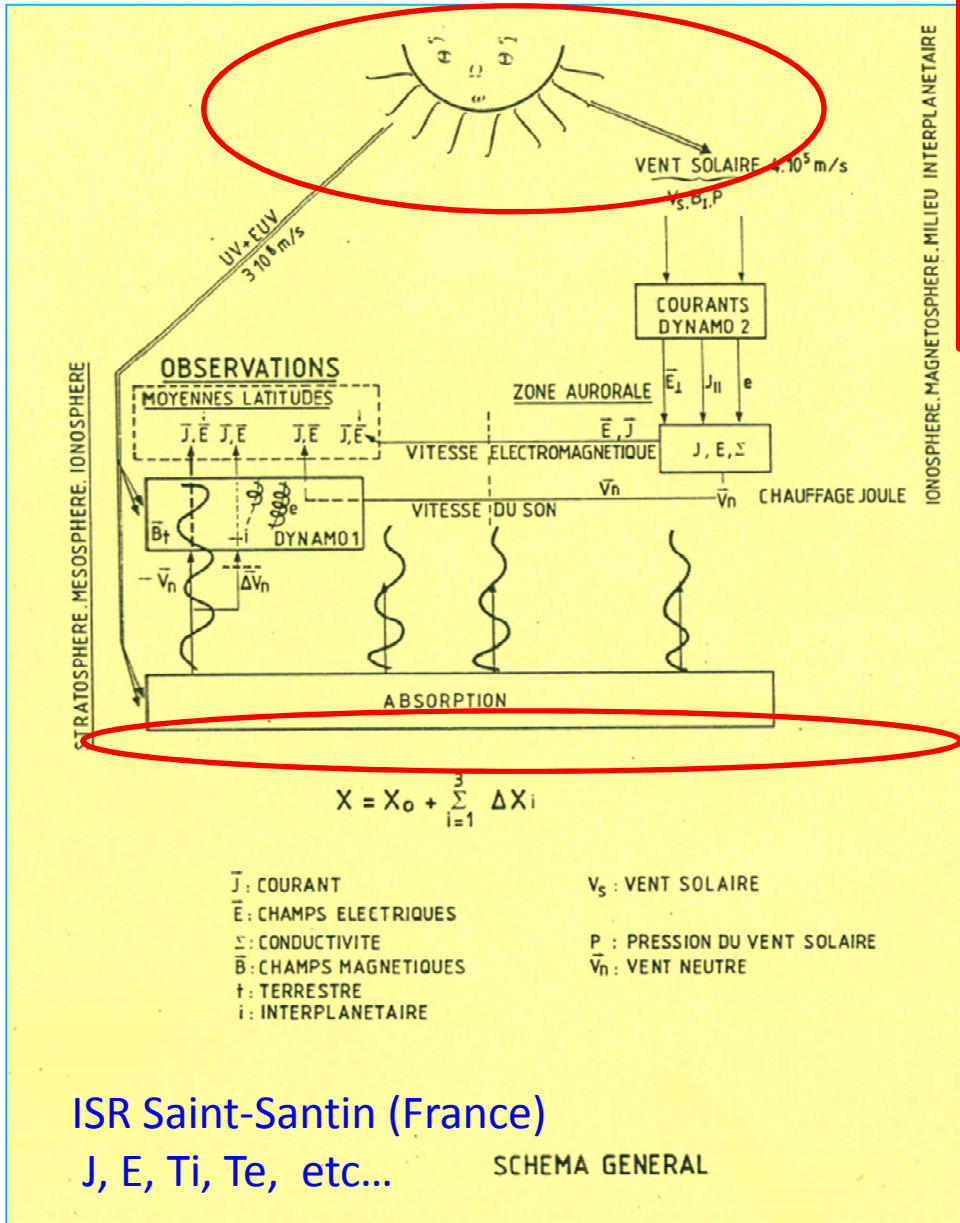

Amory-Mazaudier, 1983

2017

IHY

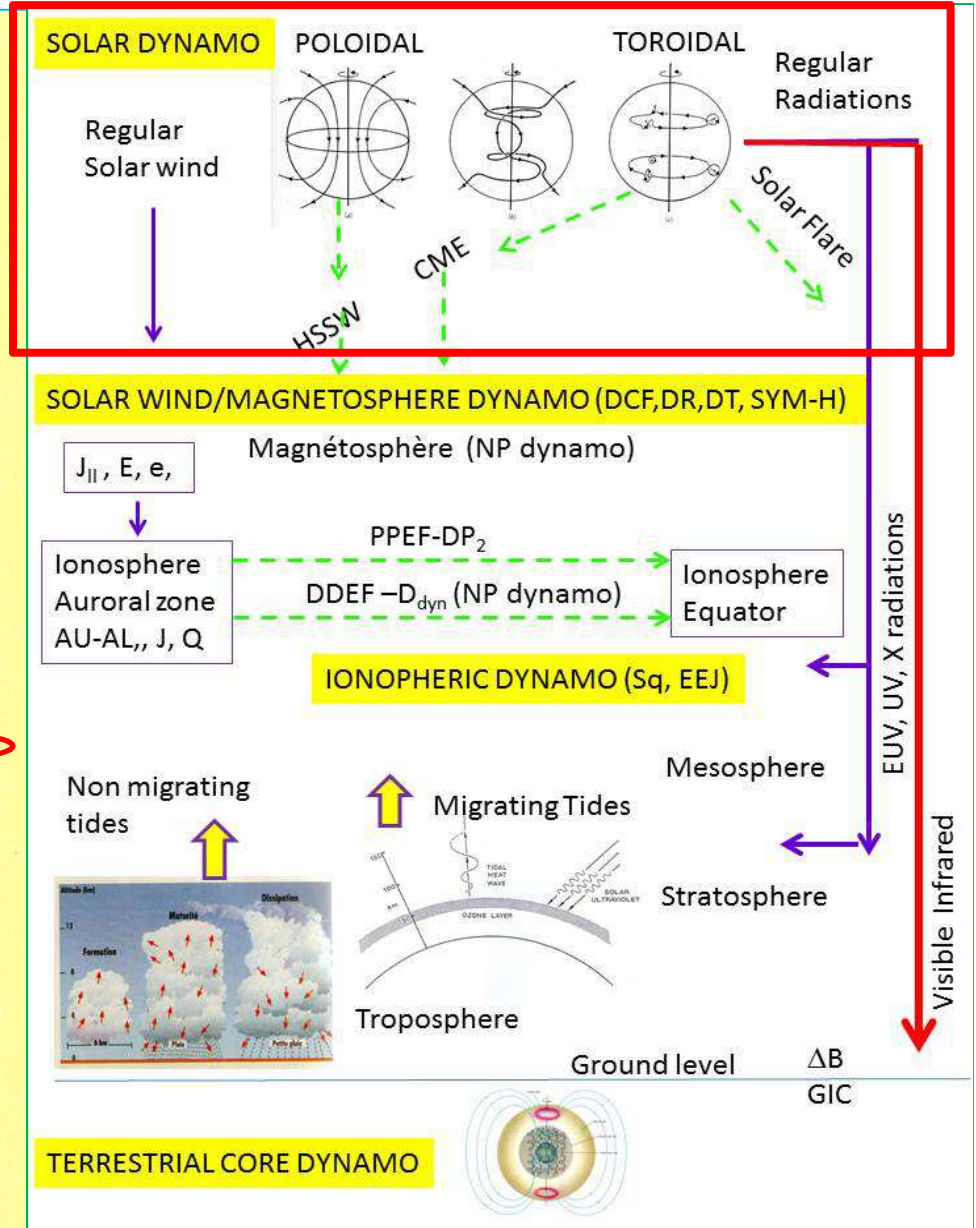

Amory-Mazaudier et al., 2017

Universal physical process : DYNAMO

Large scale phenomena impacting the Earth's magnetic field

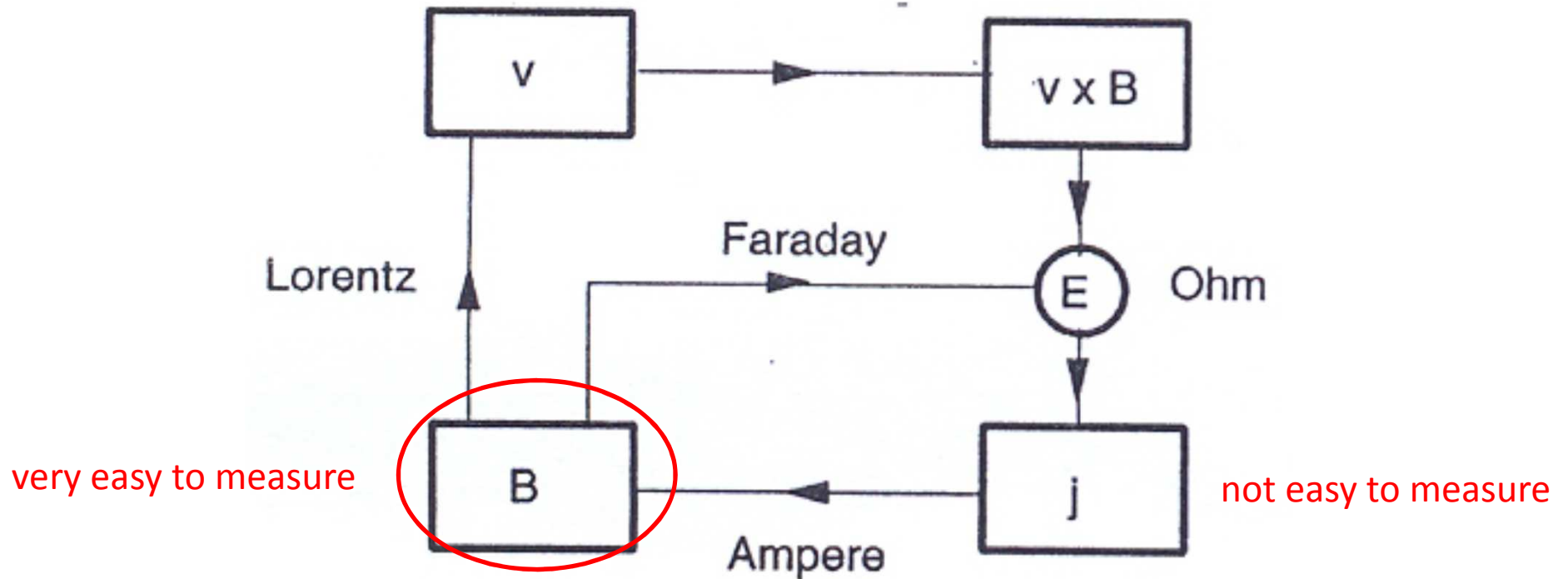

Schematic representation between plasma motion and magnetic field [after Paterno, 2006]. Comments by Paterno 'A motion v across a magnetic field B induces an electric field $v \times B$, which produces an electric current $J = \sigma (E + v \times B)$ via Ohm's law where σ is the electric conductivity and E an electric field. This current produces in turn a magnetic field $\nabla \times B = \mu j$, where μ is the permeability. The magnetic field creates both electric field E through Faraday's law $\nabla \times E = -\delta B / \delta t$ and Lorentz force $j \times B$ which reacts on the motion

Need to integrate physical processes without losing the knowledge built in each field of research during the previous decades

Need for a systemic approach with all data
and all models

EMISSIONS FROM THE SUN

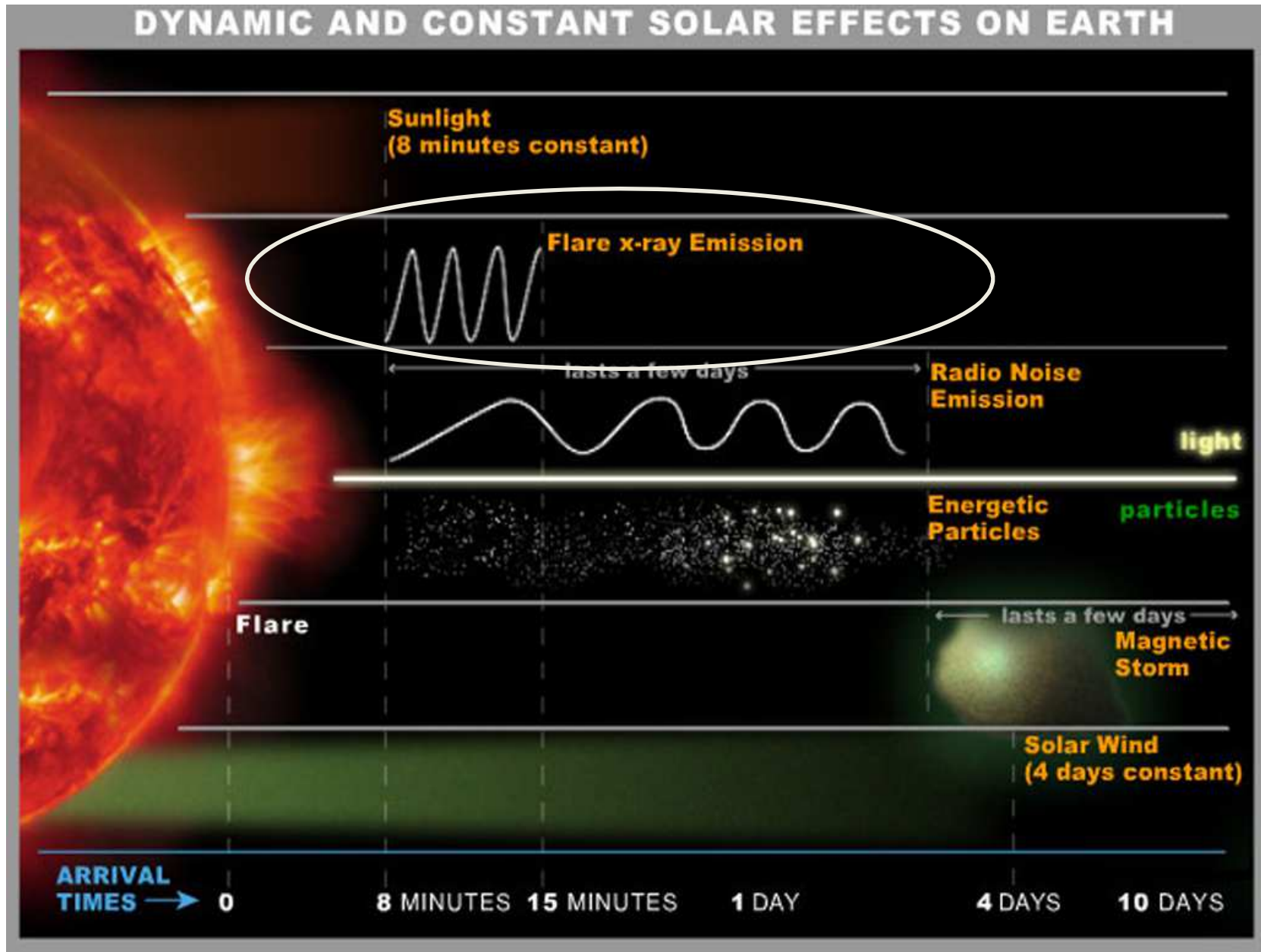

from Nasa website

Case studies : solar flare,
no interaction with the magnetosphere

Radiation channel

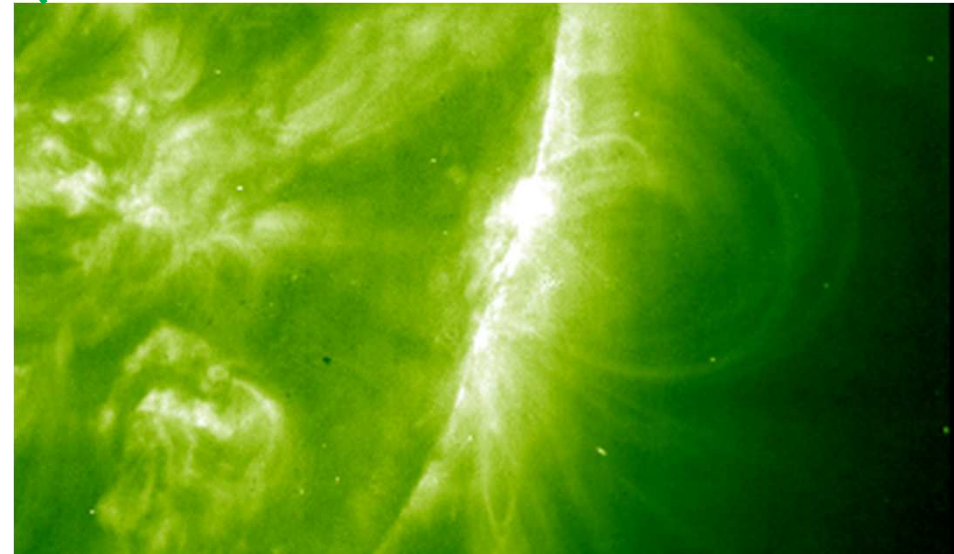
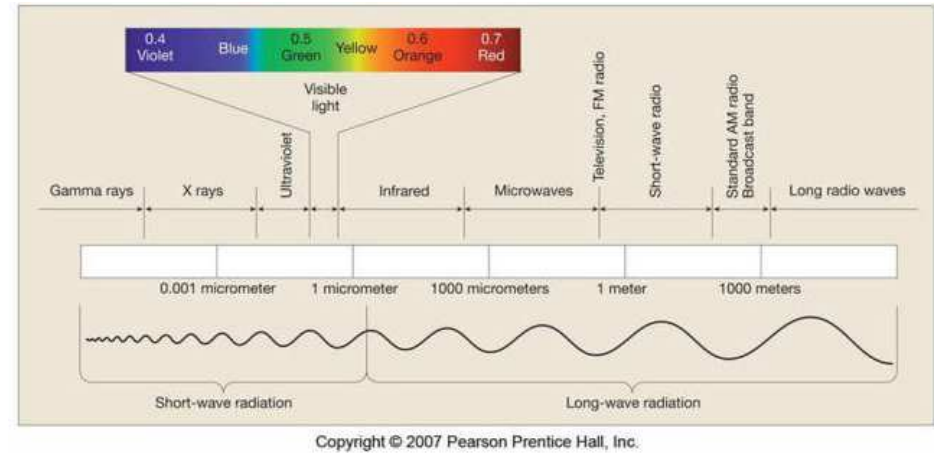
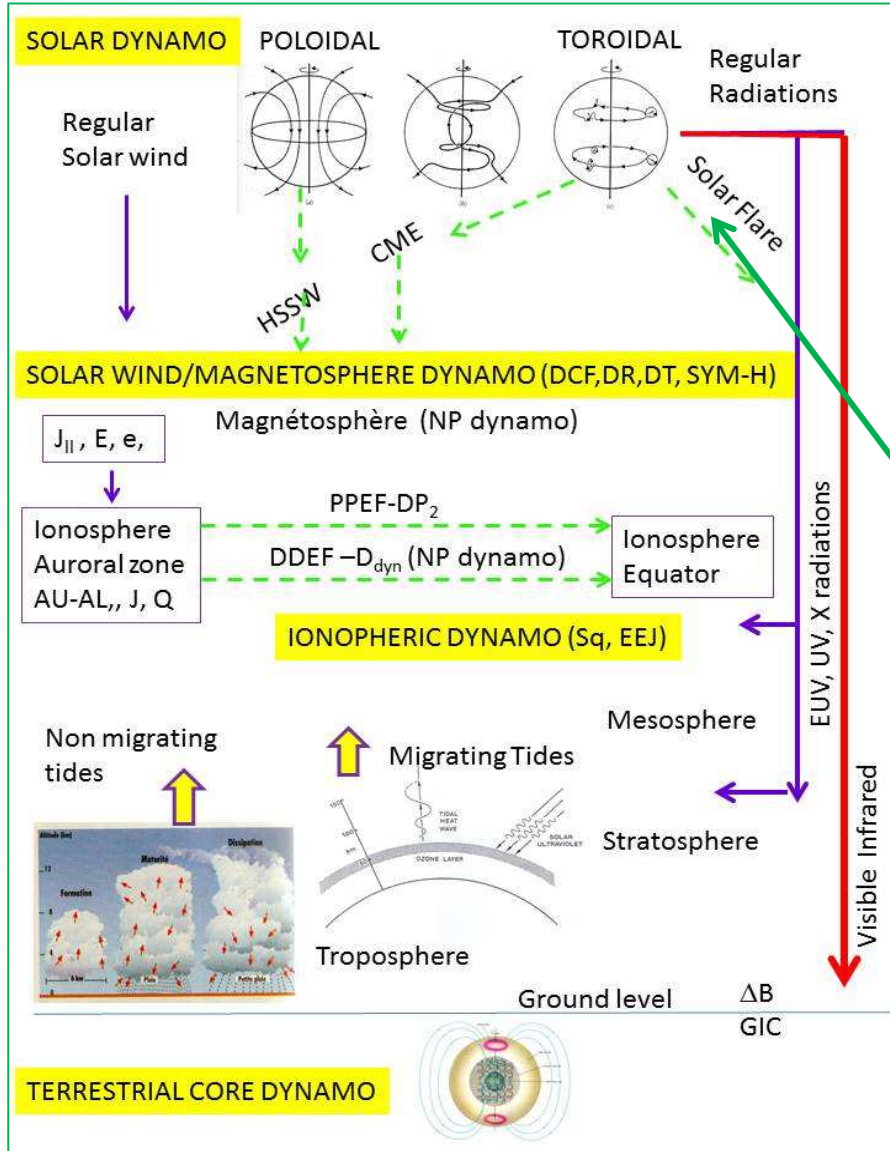

Observatory of Ebre -J.J Curto PhD 1992 and Curto et al., JGR 1994

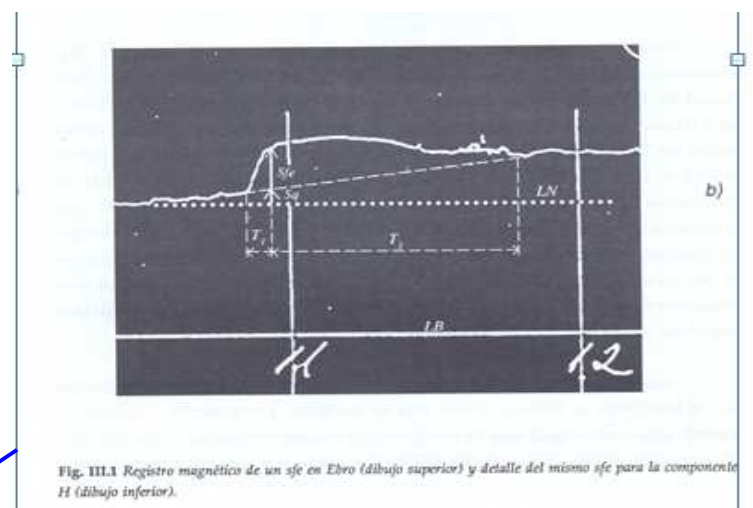
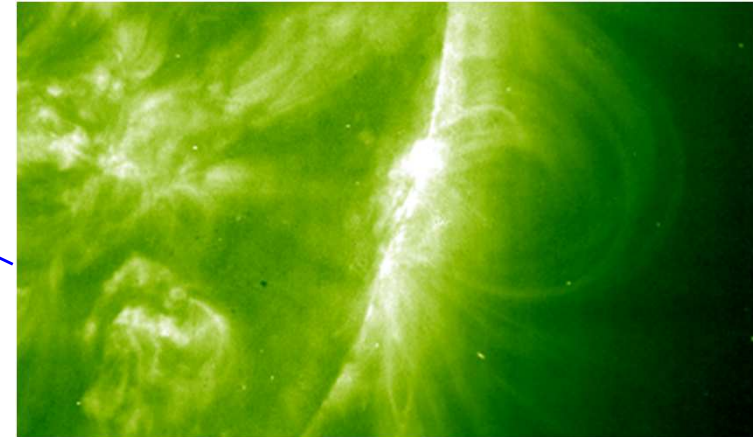
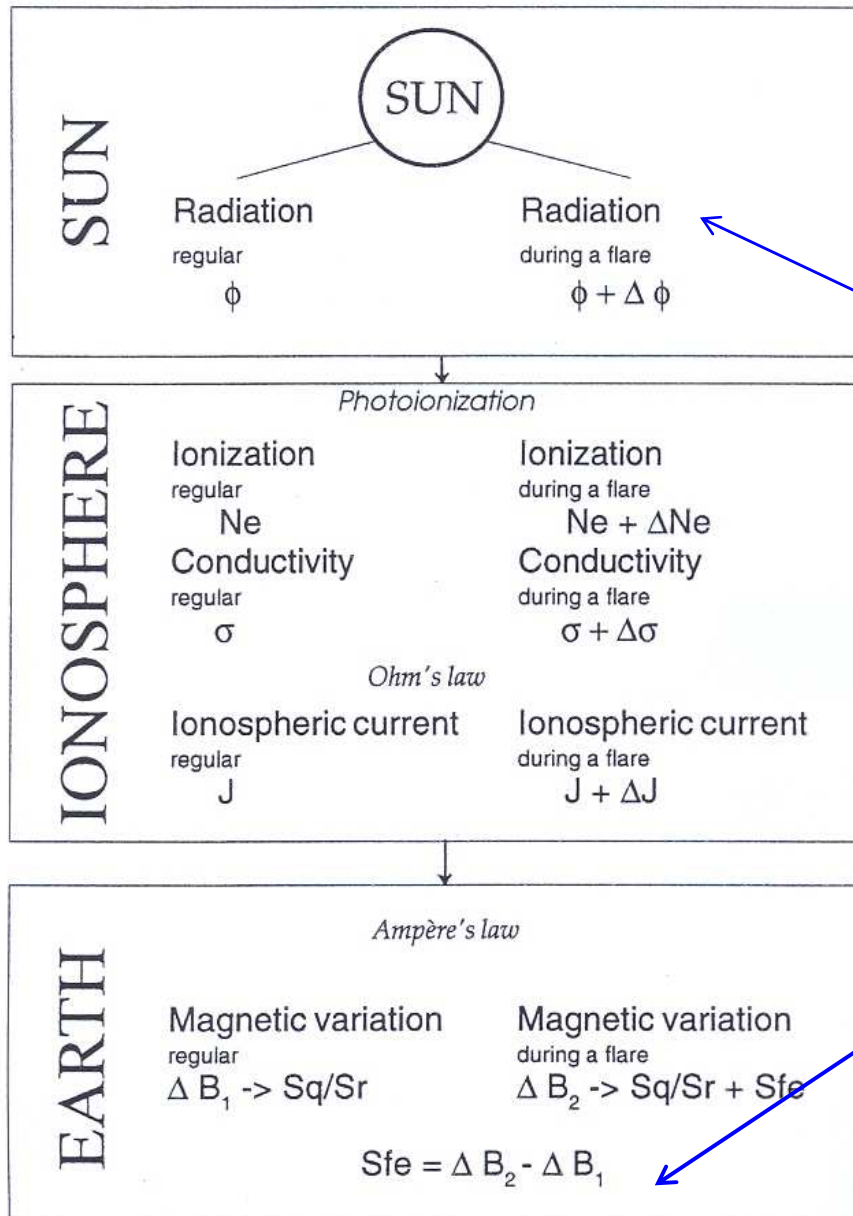

Fig. 11L1 Registro magnético de un sfo en Ebre (dibujo superior) y detalle del mismo sfo para la componente H (dibujo inferior).

Magnetic variation : crochet
 Sometimes the crochet is reversed
 WHY ?

Ionospheric dynamo

Dynamo layer 90-160km

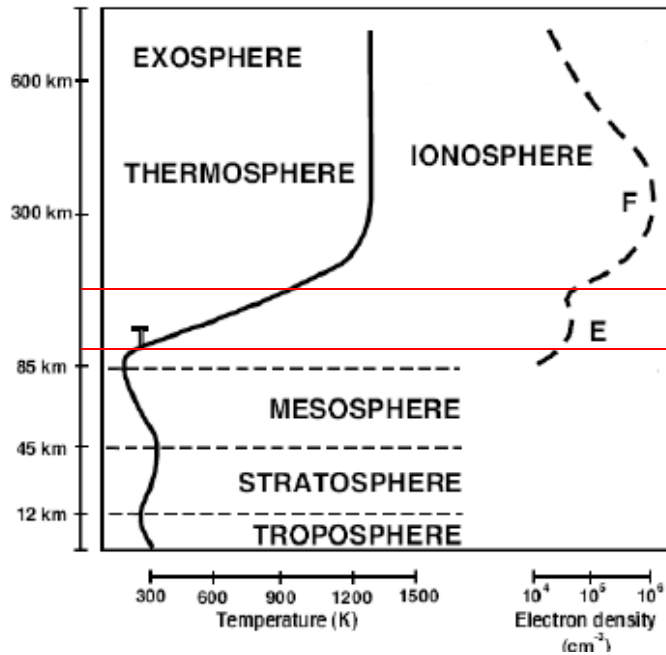

Table 1. Main Processes and Related Models Used.

		Source
<i>Sun Processes</i>		
Models	regular radiation flux	<i>Heroux et al. [1974]</i>
	flare radiation flux	<i>Donnelly [1976]</i>
<i>Ionosphere Processes</i>		
Equations	ion production rate	<i>Dymek [1989]</i>
	continuity equation	<i>Dymek [1989]</i>
	collision frequencies	<i>Stubbe [1968]</i>
Conductivity tensor (σ)		$\bar{\sigma} = \begin{pmatrix} \sigma_P & \sigma_H & 0 \\ -\sigma_H & \sigma_P & 0 \\ 0 & 0 & \sigma_{ } \end{pmatrix}$
Ohm's law		$J = \sigma (E_p + V_n \times B)$
Models	Neutral composition	<i>Hedin [1987]</i>
	Ion composition	<i>Oliver [1975]</i>
	Electric fields (E_p)	<i>Blanc and Amayemc [1979]</i>
	Neutral winds (V_n)	<i>Bernard [1978]</i>
	Electric current	<i>Mazaudier and Blanc [1982]</i>
<i>Ground Level Processes</i>		
Ampere's law		$\Delta B = 2\pi / 10f \int j dz$

1

2

3

4

1 : the solar flare Radiation on the Sun

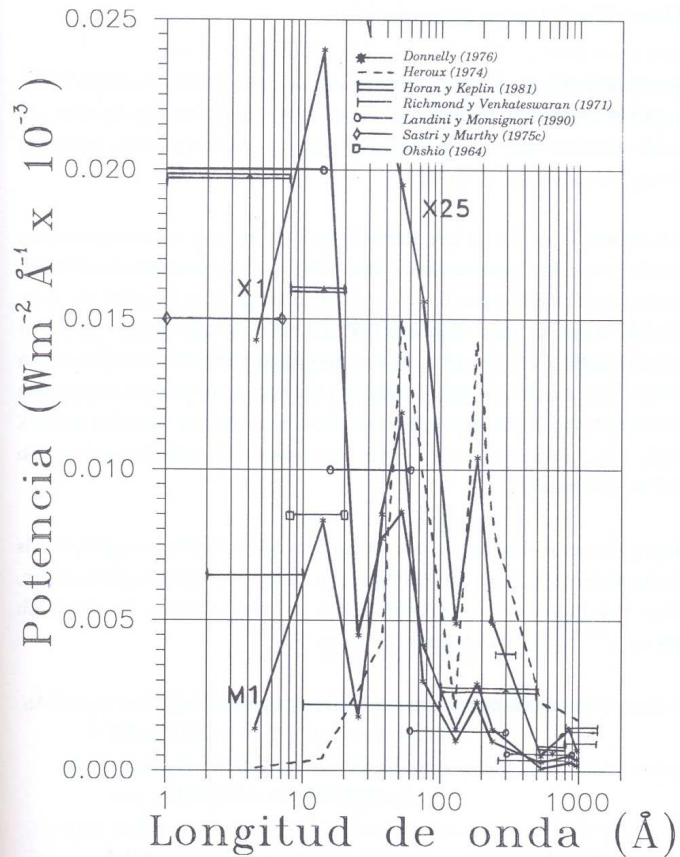

Fig. VI.2 Valores de la potencia espectral para los distintos modelos de radiación emitida durante una fulguración solar.

2.: Ionosphere Increase of ionization

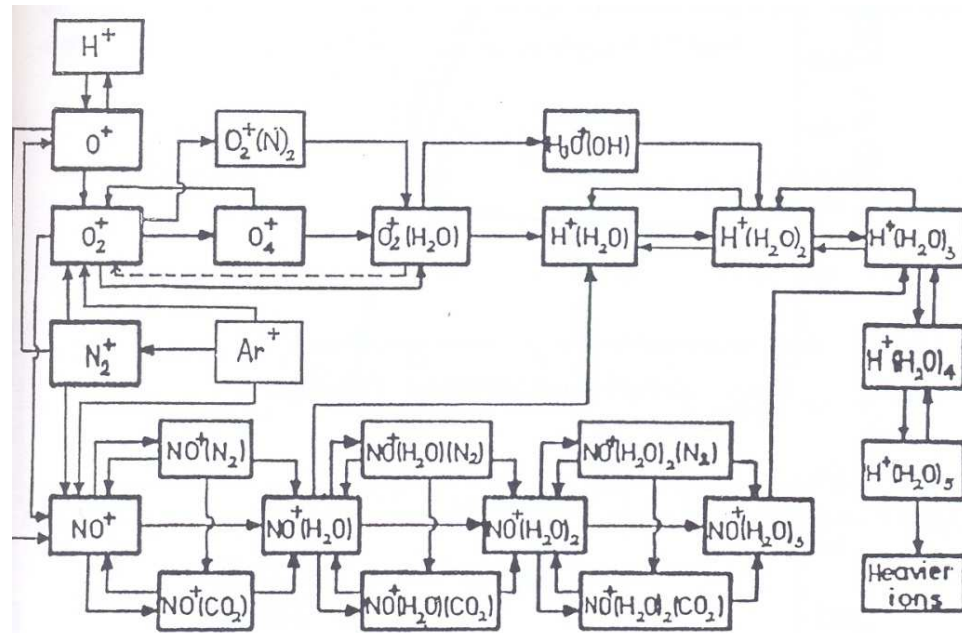

Fig. VI.4 Esquema de las reacciones químicas principales en el cálculo de los iones positivos. De Dymek (1989).

From Curto 's PhD 1992

3 :Ionosphere : electric current density (ISR model)

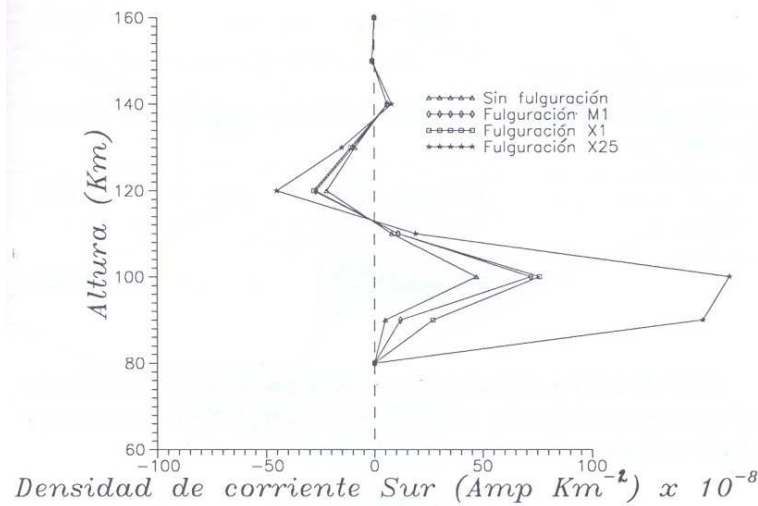
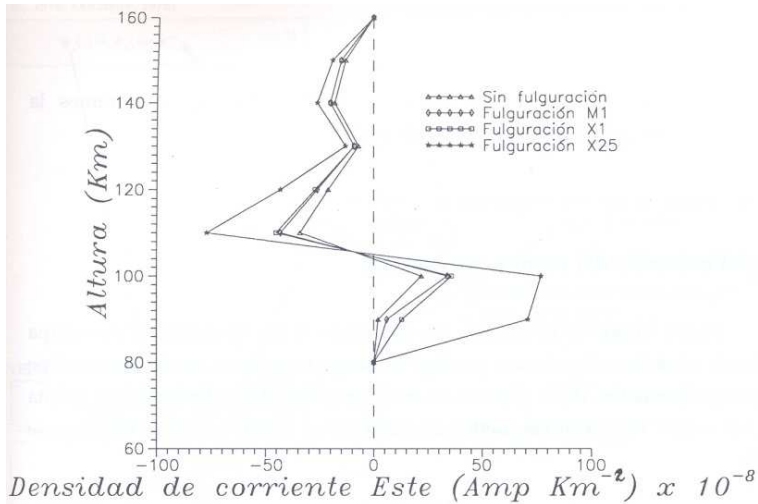
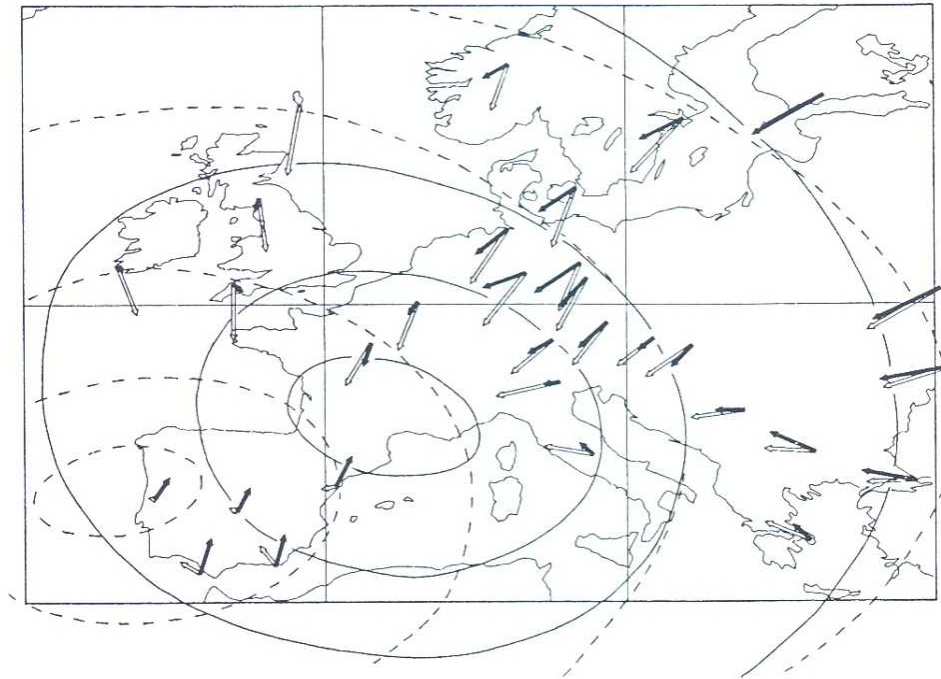

Fig. VI.15 Densidad de corriente Este (a) y Sur (b) para cada uno de los tipos de fulguración para un día equinoccial medio a las 11 horas locales (en nuestra latitud).

4 : Magnetic signature of the solar flare Solar flare -> black arrows

a)



b)

Curto et al., JGR, 1994

ANSWER:

The reversed current is related to the profile of the neutral wind in the dynamo layer

There is a real need to train on the use of magnetic data

BIOT and SAVART's Law : the Earth's magnetic field integrates the effects of all the electric current systems

The shape of a curve does not give certainty on mechanism physics : **It is necessary to analyze the whole system**

Example:

CEJ : magnetic quiet time phenomena

Disturbance dynamo: magnetic disturbed time phenomena

Counter Electrojet : CEEJ

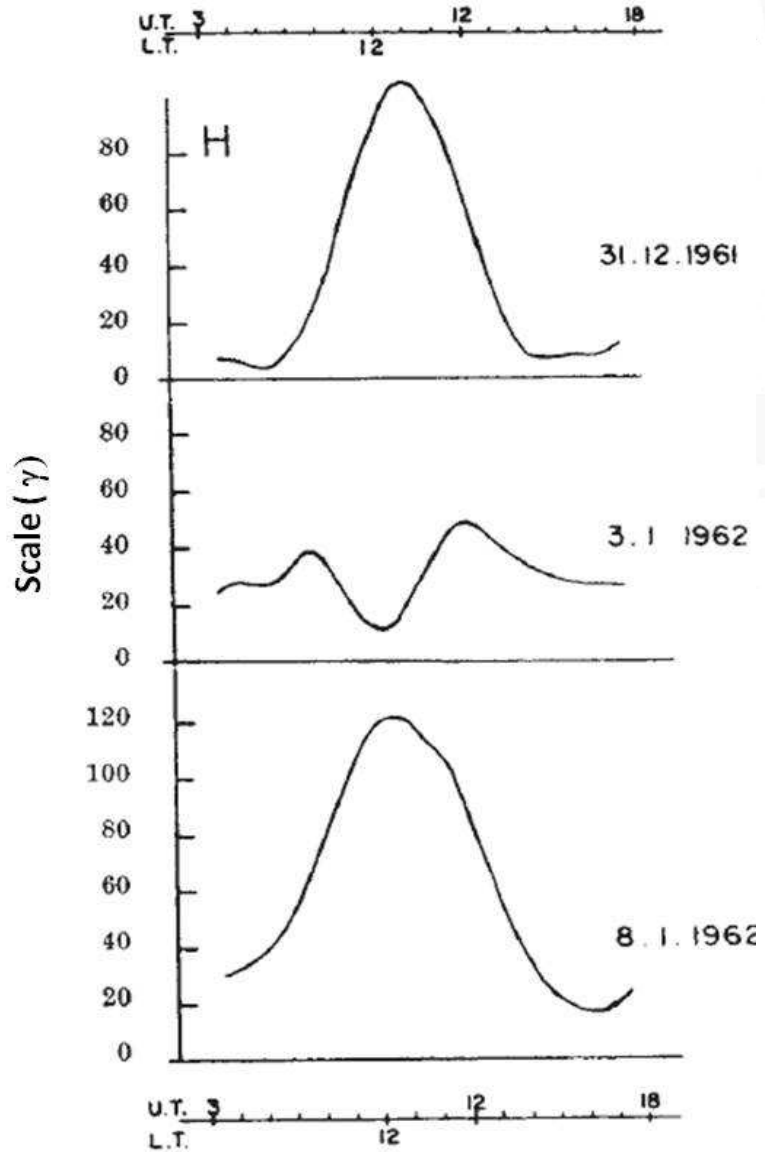

Horizontal component
Gouin, Nature, 1962

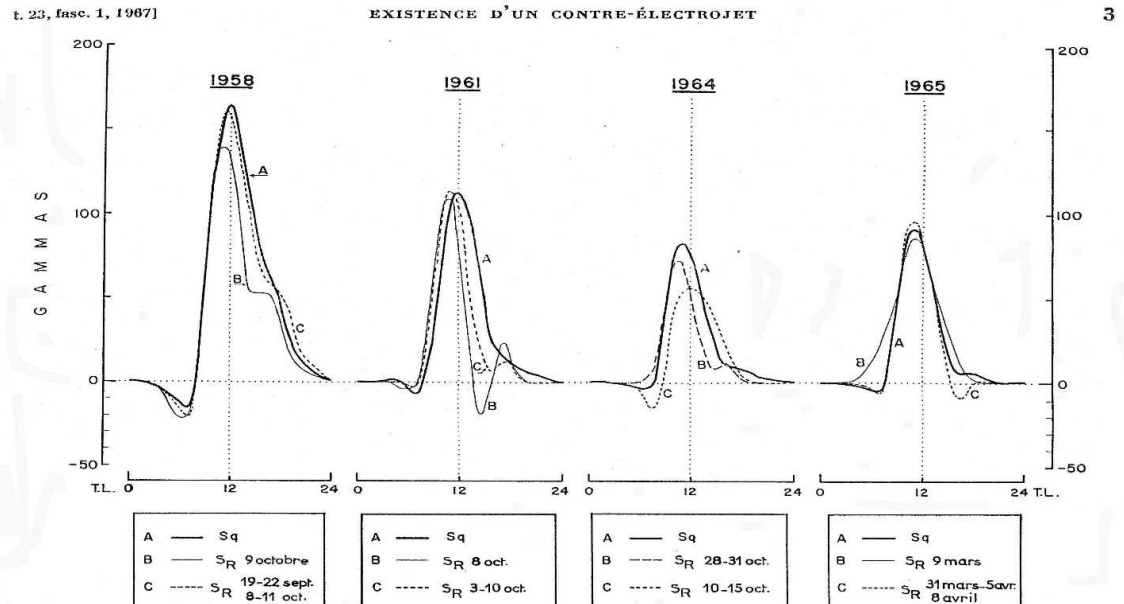
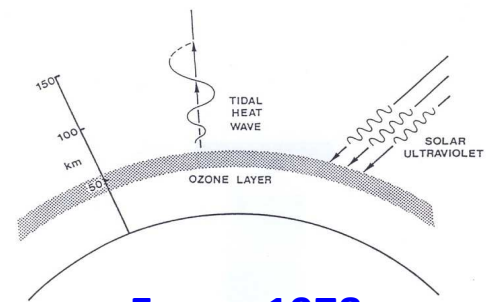
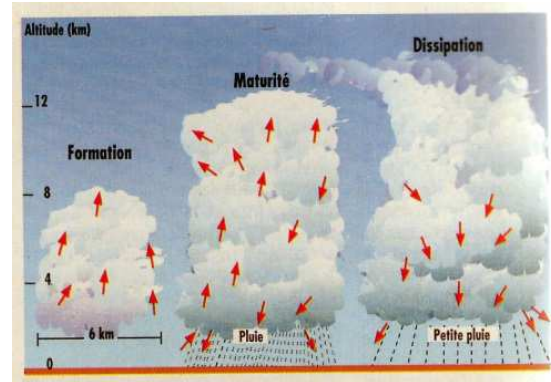

FIG. 1. — Courbes Sq d'équinoxe et courbes SR pour un jour individuel ou pour une série de jours individuels de la même saison de la composante H à Addis-Abeba, corrigées de la variation non-cyclique.

Gouin and Mayaud, 1967

CHANNEL RADIATION /SOURCE LOW ATMOSPHERE



Evans, 1978

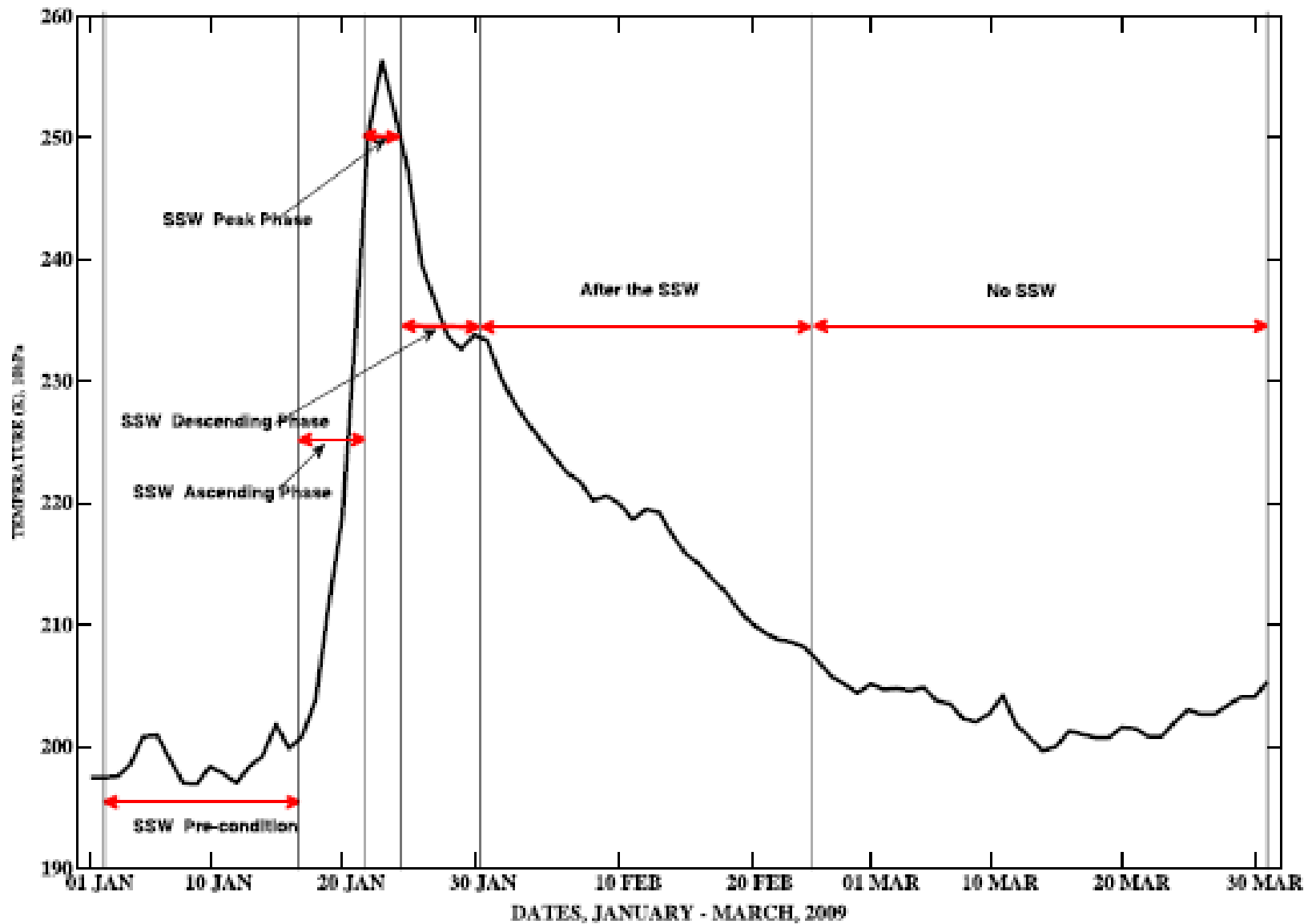

a: Stratospheric zonal mean air temperature for January – March, 2009 showing the SSW Pre-condition, SSW Ascending, SSW Peak, SSW Descending, After the SSW and No SSW Phase.

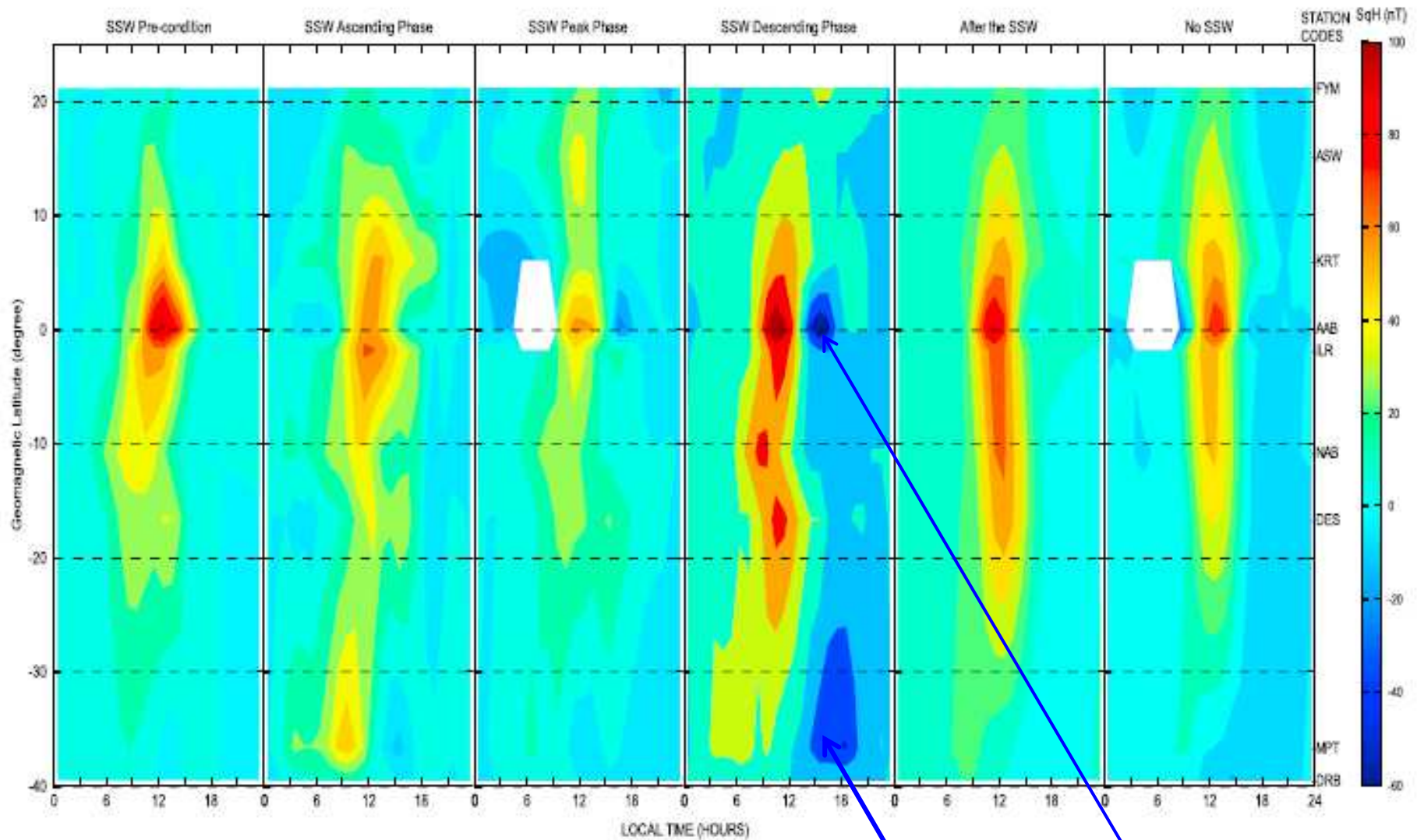

Figure 3. Two-dimensional plot of $S_q(H)$ as a function of local time across nine stations in Africa during the year 2009 SSW

MAGDAS network

Counter electrojet : CEJ

COUPLING between AURORAL and EQUATORIAL regions
 Storm winds and ionospheric disturbance dynamo
 => delay between the auroral and equatorial regions
 DDEF: Disturbance Dynamo Electric Field

Auroral electrojets



Joule heating most effective



$+ \Delta V_n \longrightarrow \Delta E_{\text{dyn}} \longrightarrow \Delta J \longrightarrow \Delta B$
 Gravity waves, HADLEY convection cell etc...

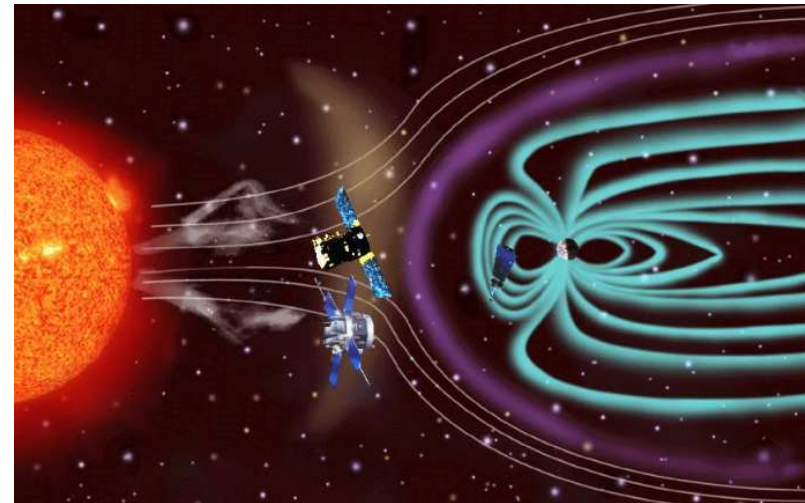

CHANNEL : SOLAR WIND / SOURCE : AURORAL ZONE

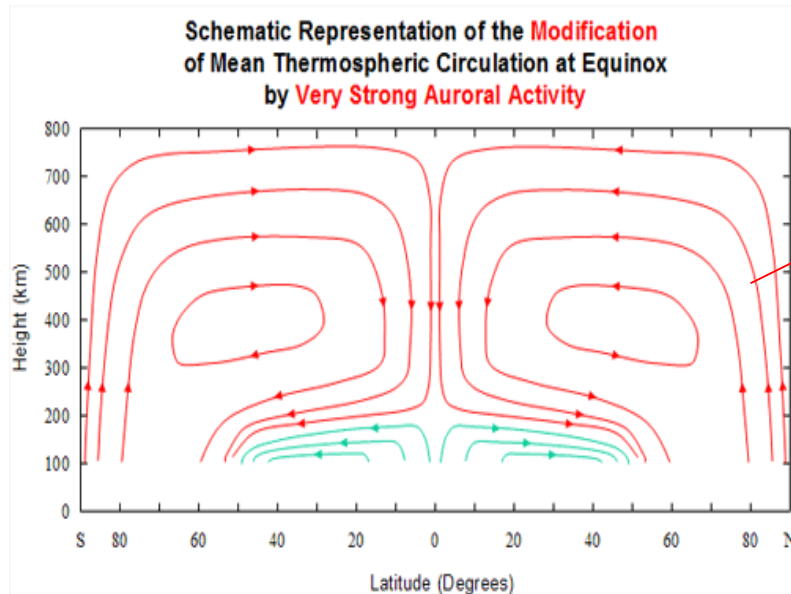
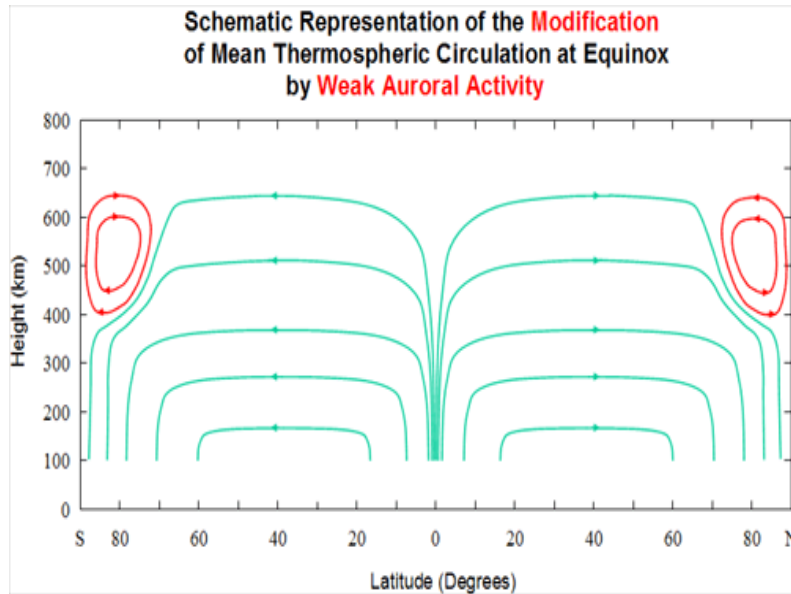

Equatorial Electric field and Electrojet

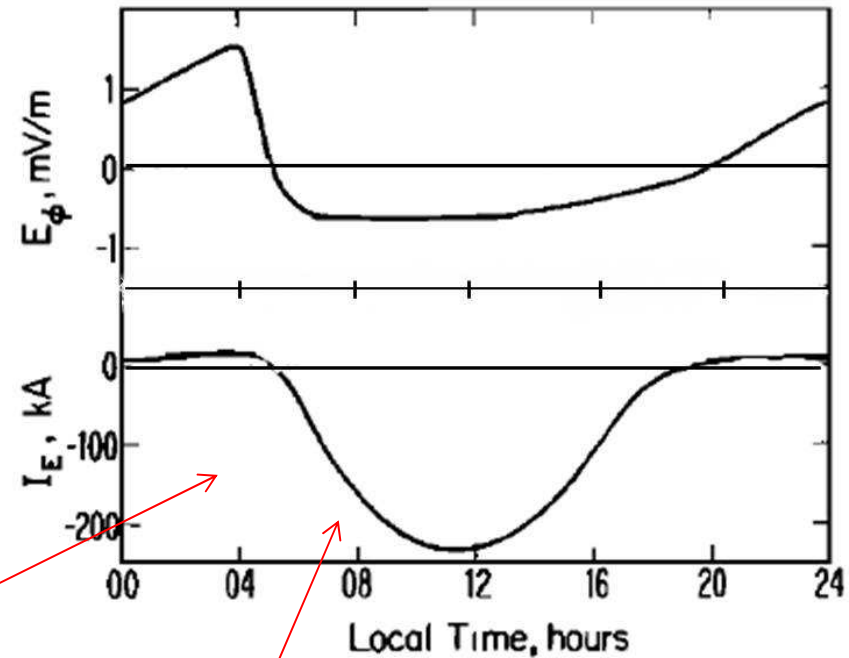

Ionospheric Disturbance Dynamo

Blanc and Richmond, 1980

REVERSED ELECTROJET

Need of historical studies on geomagnetism

Legacy of IGY 1957

- On the historical origins of the CEJ, DP2 and Ddyn current systems and their roles in the predictions of ionospheric responses to geomagnetic storms at equatorial latitudes, J. Geophys. Res., doi: 10.1002/2017JA024132
- C. Amory-Mazaudier, O.S. Bolaji and V.Doumbia
- Base of Knowledge

**4 PERMANENT DYNAMOS
+ (Non Permanent DYN.)**

SUN

poloidal /toroidal

MAGNETOSPHERE (+NP)

Solar wind

IMF

IONOSPHERE (+NP)

Earth's magnetic field

Neutral wind

EARTH

Motions of the core

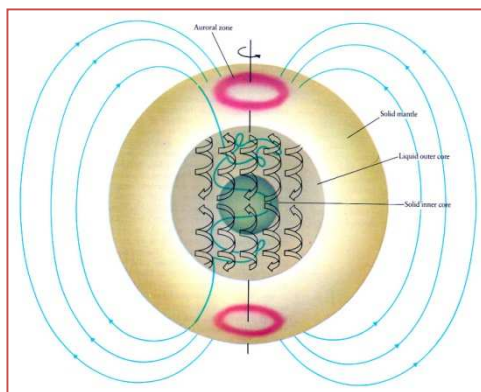

Not exhaustive

NEW SYSTEMIC TRAINING

CURRENT SYSTEMS

MAGNETOSPHERE

Chapman Ferraro

Ring current

Tail current

BIRKERLAND

CURRENT

IONOSPHERE

Auroral electrojets

Midlatitude currents

Equatorial electrojet

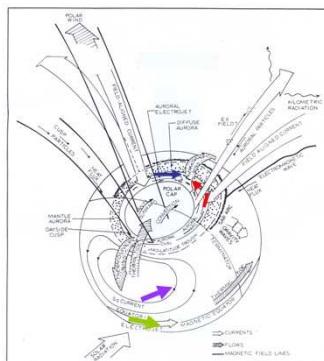

**EARTH'S MAGNETIC
FIELD -> Transient
variations**

Indices -> disturbances

Dst, SYM-H, ASYM-H

Aa, Kp, Ap

Km, Am

AU, AL

Equivalent currents

DP1, DP2, Ddyn

S_R <Sq>, Sq^P

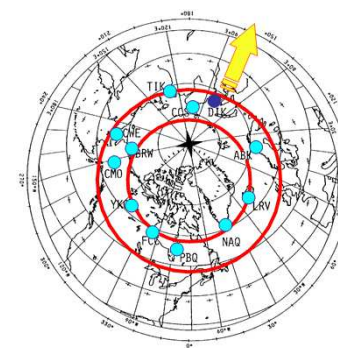

PERMANENT DYNAMOS : some order of magnitude

Dynamo	Motions – V	Magnetic field B	Order of Magnitude
Sun	Sun Rotation and convection	Sun : 2 components Dipolar Toroidal = sunspot	rotation speed : ~ 7280km/h at the equator Dipolar component : ~10 G Toroidal component : ~3-5 kG
Solar wind Magnetosphere	Solar wind	Interplanetary medium -> B _i	speed ~ [400km/s to 1000km/s] B _i ~ qq 10 nT
Atmospheric wind Ionosphere	Atmosphere	Earth's -> B _t	speed ~ 100m/s B _t ~ qq 10 000 nT
Earth's Dynamo inside the Earth	Metallic core	Earth's -> B _t	Indirect measurements deduced from the Earth's planetary magnetic field and the secular variation Velocity ~ qq km/year B _t ~ qq 10 000 nT



Summary : 10 years after IHY

The perennality is assured

- Science : new training
- Data analysis : new systemic approach
- Knowledge : work on history => base of Knowledge on the web
- GIRGEA team : **29 PhD** (2007-2017, **22 in Africa**) + 4 before the end of the year (students from Burkina Faso, Côte d'Ivoire, RC, RDC)
- Next school in Abidjan (**16-28 October 2017**) organized by V. Doumbia from Côte d'Ivoire
- Curricula at University (Algeria, Burkina Faso, Côte d'Ivoire, Morocco, RC, RDC, Senegal and soon in Cameroun and Guinea Conakry)
- Outreach : conference on space weather and use of GPS in schools (power point in French, English and soon Spanish and Italian)

Some references

- Amory-Mazaudier, C., .S. Bolaji, V. Doumbia, (2017), On the historical origins of the CEJ, DP2 and Ddyn current systems and their roles in the predictions of ionospheric responses to geomagnetic storms at equatorial latitudes, *J. Geophys. Res.*, doi: 10.1002/2017JA024132
- M. Blanc, A.D. Richmond, The ionospheric disturbance dynamo, *J. Geophys. Res.*, 85, A4 (1980), pp. 1669-1686, doi: 10.1029/JA085iA04p01669
- O.S. Bolaji, E.O. Oyeyemi, O.P. Owolabi, Y. Yamazaki, A.B. Rabiou, D. Okoh, A. Fujimoto, C. Amory_Mazaudier, and A. Yoshikawa, Solar quiet current response in the African sector due to a 2009 sudden stratospheric warming event" , *J. Geophys. Res., Space Physics*, 121, 8055-8065, doi:10.1002/2016JA022857
- J-J. Curto, C. Amory-Mazaudier, M. Menvielle, J.M. Torta, Study of Solar Flare Effects at Ebre: 1. Regular and reversed SFe, Statistical analysis (1953, 1985) and a global case study, *J. Geophys. Res.*, 99, A3 (1994a) pp. 3945-3954.
- J-J. Curto, C. Amory-Mazaudier, J.M. Torta, M. Menvielle, Study of Solar Flare Effects at Ebre: 2. Unidimensional physical integrated model, *J. Geophys. Res.*, A12 (1994b) pp. 23289-23296.
/JA073i005p01795.
- Gouin P. (1962), Reversal of the magnetic daily variations at Addis Ababa. *Nature* 139: 1145-1146.
- Gouin, P. and P.N. Mayaud (1967), A propos de l'existence possible d'un contre-électrojet aux latitudes magnétiques équatoriales, *Ann. Géophys.*, 23, n° 1, p. 41-47.
- M. Le Huy, C. Amory-Mazaudier, Magnetic signature of the ionospheric disturbance dynamo at equatorial latitudes: "Ddyn", *J. Geophys. Res.*, 110, A10301 (2005). doi:10.1029/2004JA010578.
- L. Paterno, History of solar cycle, in *Historical events and people*, W. Schröder, ISSN-1615-2824, AKGGP/SHGGCP, science Edition Bremen/Postdam (2005) pp. 261-275.
- A. Richmond, Ionospheric Electrodynamics , in *Atmospheric Electrodynamics*, Vol II, Chapter 9 (1995) pp 249-280, Edited by Hans Volland.